

Upright Freezer Top View

FREEZER SPECIFICATIONS		
CAPACITY	22 CUBIC FEET	
STYLE	UPRIGHT	
NET WEIGHT	850 LBS.	
SHIPPING WEIGHT	975 LBS.	
INTERIOR DIMENSIONS		
INTERIOR WIDTH	28.5"	(72.4 cm)
INTERIOR DEPTH	26.0"	(66.1 cm)
INTERIOR HEIGHT	51.25"	(130 cm)
EXTERIOR DIMENSIONS		
EXTERIOR WIDTH	43.0"	(109.2 cm)
EXTERIOR DEPTH	37.0"	(93.9 cm)
EXTERIOR HEIGHT	79.5"	(201.9 cm)
EXTERIOR CRATED DIMENSIONS		
CRATED WIDTH	46.0"	(116 cm)
CRATED DEPTH	43.0"	(109 cm)
CRATED HEIGHT	86.0"	(218 cm)

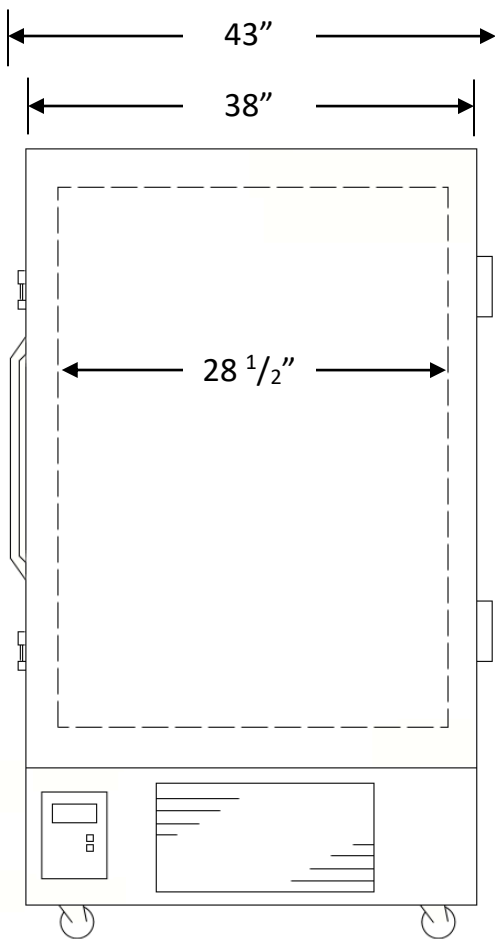

Upright Freezer Front View

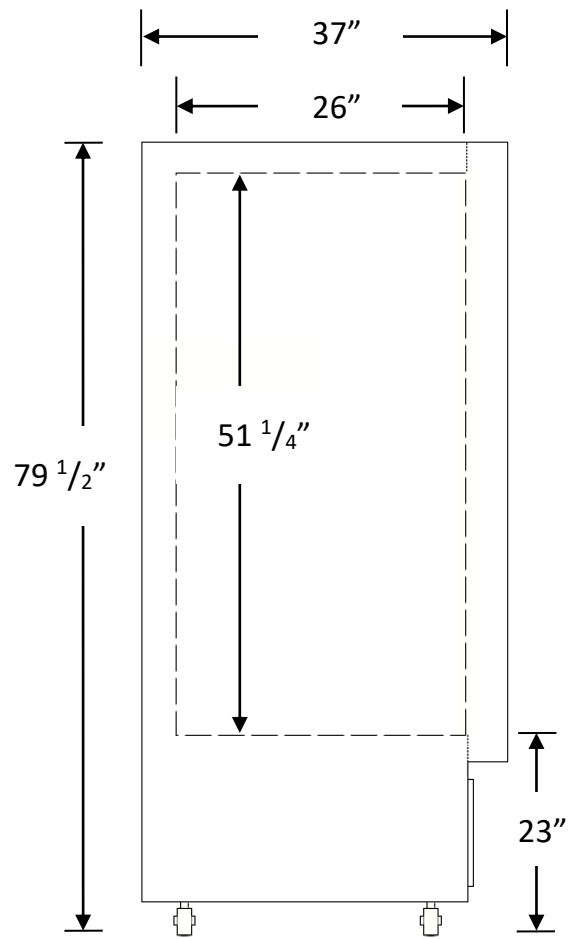

Upright Freezer Side View