

OPTIKA[®]
M I C R O S C O P E S
I T A L Y



MICROSCOPY CATALOGUE

OPTIKA Milestones









































- 
- 1996** First **LED brightfield** microscope in the world
 - 2002** First **2-in-1 gemological** microscope in the world
 - 2002** First **LED darkfield** illuminator for stereomicroscopes in the world
 - 2003** First **LED fluorescence** microscope in the world
 - 2004** **Infinifix** (infinity optical system with 160mm objectives)
 - 2005** First **LED metallurgical** microscope
 - 2006** **X-LED** illumination system - the original
 - 2007** First **LED darkfield** illuminator **for blood analysis** in the world
 - 2008** First **Windows tablet PC with integrated microscope camera** in the world
 - 2009** First full **Automatic Light Control (ALC)** in the world
 - 2010** Full **motorized microscope controlled by mouse** in the world
 - 2011** Full **motorized microscope controlled by touch-screen monitor** in the world
 - 2013** First **digital microscope with integrated Windows tablet PC** in the world
 - 2015** First **rechargeable microscope with Li-Ion battery** in the world
 - 2017** First **educational microscope with oil/water 100x** objective in the world
 - 2023** **X-OEF (Optika EasyFocus System)** Electronically controlled triple focus adjustment

INDEX

① EDUCATIONAL Microscopes	page 7
② LABORATORY Microscopes	page 79
③ INSPECTION & INDUSTRIAL Microscopes	page 279
④ CAMERAS & DIGITAL Solutions	page 355
⑤ POLARIMETRY AND REFRACTOMETRY	page 437



Complete Icon List

 Field number	 U-Plan objectives (up to 24mm f.o.v)	 Tablet screen size
 Incident light	 Oil/Water 100x objective	 Camera resolution
 Transmitted light	 Fluorescence	 CCD sensor
 LED illuminator	 Metallography	 CMOS sensor
 X-LED illuminator	 Polarized light	 Software included
 Automatic light control	 Darkfield	 HDMI output
 Multi-Plug low voltage power supply	 Phase contrast	 SD/MicroSD slot
 Rechargeable battery	 Differential interference contrast	 Wi-Fi
 Li-Ion rechargeable battery	 Fixed objective	 BlueTooth
 IOS infinity corrected optics	 Zoom objective	 Cooling system
 High contrast objectives	 USB 2.0 input (mouse)	 Mouse included
 N-Plan objectives (up to 20mm f.o.v)	 USB 2.0 output	 IVD Available *
 W-Plan objectives (up to 22mm f.o.v)	 USB 3.0 output	 Antibacteria treatment available
 X-OEF system (Optika EasyFocus system)		

* The **IVD** code must be requested at order

OPTIKA X-OEF System

X-OEF

Optika is proud to introduce the first routine microscope with fully electronically controlled triple focus adjustment: Macro, Semi-Micro and Micro.

The new **X-OEF** system (Optika EasyFocus system) replaces the classic mechanical focusing system with an innovative solution that allows more functions.

EasyFocus allows the selection of three different resolutions (shift for each step):

Macro (250 μm); Semi-Micro (8 μm); Micro (1 μm)

The single knob allows the focus movement and the selection of the resolution is easily controlled by pressing it. Each focus resolution (Macro, Semi-Micro and Micro) is clearly displayed to the user by three dedicated blue LEDs.

The presence of a Semi-Micro adjustment with 8 μm resolution makes finding the focus point with medium-low magnification objectives (10x,20x) exceptionally convenient and quick. The **X-OEF** system includes a stage retraction function that facilitates and speeds up immersion oil laying and slide changing operations.

B-820 is the result of OPTIKA Microscopes' long experience in the field of optical microscopy, offering an extremely valuable product for routine and research applications in brightfield and phase contrast.

Personal requirements are met in terms of application as well as ergonomics thanks to the microscope's extensive modularity.

The innovative B-820 model is a particularly high-performance and robust solution, offering 22mm field of view, the unique **X-LED³** illumination source (3.6 W) and a sturdy dye-cast structure for high stability, combined with a wide choice of heads, objectives and condensers.

Two different stands and mechanical stages are available for both right and left-handed users.



New IM-300 Series



OPTIKA is pleased to present the brand new range of **IM-300** inverted microscopes.

These models, completely redesigned, offer exceptional working comfort and routine use of the highest level.

Inverted microscopes are useful for observing living cells or organisms at the bottom of a large container (for example, a tissue culture flask) under more natural conditions than on a glass slide, as is the case with a conventional microscope.

The **IM-300 series** includes a version for the simultaneous brightfield and phase contrast method, designed and engineered to be the ideal solution for fast and reliable routine inspections.

The round glass stage surface allows for optimal visual access to the objective turret.

A particularly simple and ingenious optical design enables stable alignments and smooth, precise movements.

The **IM-300 range** is completed with digital versions equipped with a large 4k touch screen monitor and a very high sensitivity camera.

OPTIKA AB-Shield



Antibacteria treatment available

Optika **AB-Shield** is a coating that allows you to treat different surfaces and guarantee the elimination and prevention of bacterial growth in hygiene-sensitive areas.

This treatment guarantees you a strong antibacterial effect due to the highly effective micro-silver additive and Destruction of 99.9% of surface bacteria.

The antibacterial effect remains for the lifetime of the coating. Also eliminates bad smells caused by bacteria. Proven effective against resistant bacteria such as MRSA, E-Coli, EHEC etc.

ISO
22196

Optika **AB-Shield** is available as an add-on to your new microscope, thus making its use healthier for yourself and when it needs to be shared among several people.



The effectiveness was successfully tested using the international standard:

ISO 22196

“Measurement of antibacterial activity on plastics and other non-porous surfaces”

against these pathogens:

Staphylococcus aureus DSM 346/ATCC 6538P
Escherichia coli DSM 1576/ATCC 8739.

The method has been tested for bacteriostatic properties (growth inhibitor) and bactericidal (killing bacteria).

OPTIKA[®]
M I C R O S C O P E S
I T A L Y



EDUCATIONAL Microscopes

EDUCATIONAL Microscopes

Biological Microscopes

ECOVISION SERIES - Entry-Level Biological Microscopes For Beginners page 9

B-60 SERIES - Entry-Level Biological Microscopes For Students page 17

B-150 SERIES - Middle-Level Biological Microscopes For Students page 25























B-190 SERIES - Advanced Biological Microscopes For Students And Teachers page 49

Stereomicroscopes

MS/SFX SERIES - Entry-Level Monoscopes & Stereomicroscopes For Students page 61

SLX SERIES - Stereomicroscopes For Students And Teachers page 71

Icons

	Field number		Li-Ion Rechargeable battery		Tablet screen size
	Incident light		High contrast objectives		Camera resolution
	Transmitted light		N-Plan objectives (up to 20mm f.o.v)		Software included
	LED illuminator		Oil/Water 100x objective		HDMI output
	X-LED illuminator		Polarized light		MicroSD slot
	Automatic light control		Fixed objective		Wi-Fi
	Multi-plug low voltage power supply		Zoom objective		BlueTooth
	Rechargeable battery		USB connection		IVD Available *
	Anti-bacteria treatment available				

* The IVD code must be requested at order

OPTIKA[®]
M I C R O S C O P E S
I T A L Y

ECOVISION Series



Entry-Level Biological Microscopes For Beginners

A Range Of Quality Microscopes For Beginners

EDUCATIONAL MICROSCOPES DESIGNED FOR NOVICE USERS

- » Designed for novice users (students and primary schools especially)
- » Easy to handle, also by the youngest users
- » Longlife LED illumination (providing over 20 years of use)
- » Compact, practical and intuitive to use
- » Sturdy and durable for extended lifetime

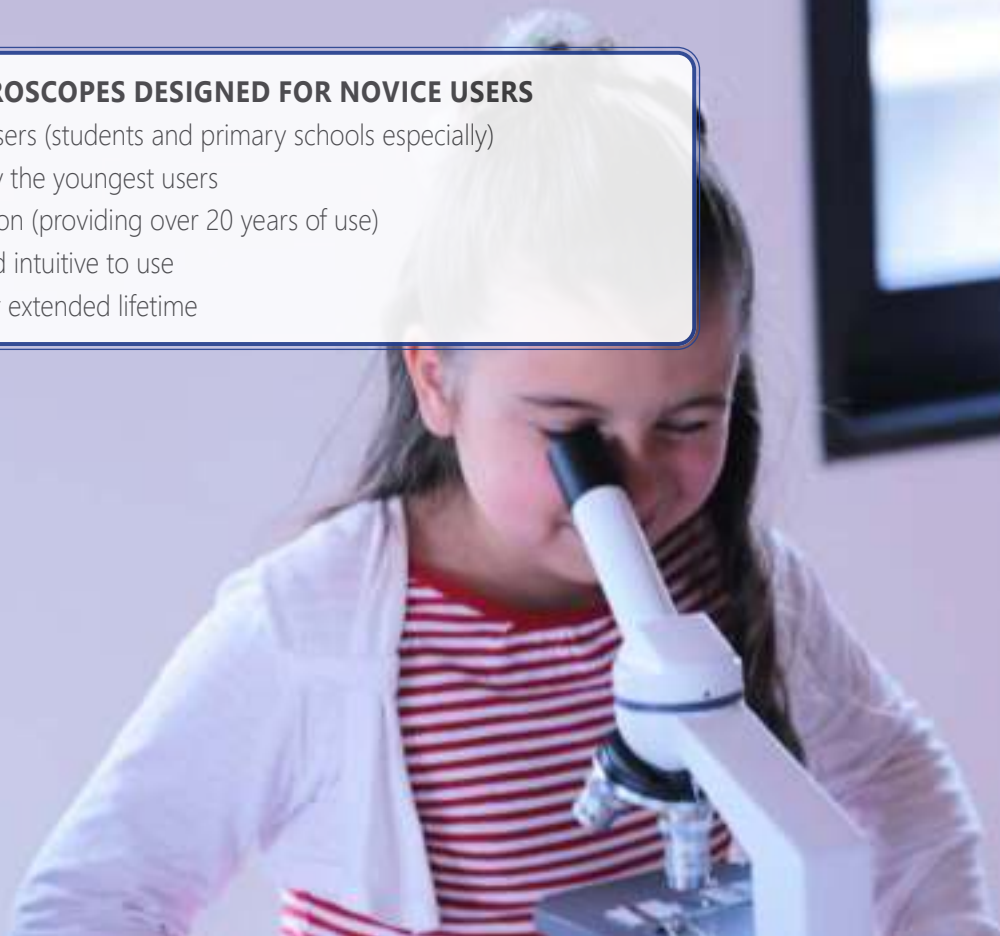

COMFORTABLE, INTUITIVE & RELIABLE SOLUTIONS

- » 18 mm field number for a wide observation area
- » Achromatic optics ensuring good contrast and quality images
- » Pre-aligned illumination and condenser to simplify operations
- » Cordless use, totally independent from mains/batteries connection
- » External power supply for enhanced safety and convenient servicing



ECOVISION Series

A range of mainly cordless monocular microscopes ideal for students and mainly primary schools with achromatic lenses, FN 18 eyepiece, finite optical system, coaxial focusing, fixed or mechanical stage and 1 W LED illumination.

Slim and easy to carry, all the models are equipped with long lasting LED illumination to provide over 20 years of use.



Easy to handle, also by the youngest users

Extreme compactness and portability to ensure easy transportation in the classroom and outdoor, with slim body and useful handle for a facilitated and enjoyable teaching activity.

Cordless use, totally independent from mains connection

Most of the models work with or without the batteries in place. For outdoor use (4-hour autonomy, at medium intensity), three NiMH rechargeable batteries must be used.

External power supply for enhanced safety and convenient servicing

OPTIKA's safety first approach drives to the use of a low voltage, multi-plug, external power supply in order to prevent any risk of electric shock and heatflow inside the unit.

Longlife LED illumination (providing over 20 years of use)

Money & energy saving thanks to LED long lifetime (65.000 hours, 22 years in case of 8 hours/day) which is more than 20 times compared to a standard halogen bulb.



B-20R



Cordless monocular microscope ideal for students and mainly primary schools, with achromatic lenses (400x), FN 18 eyepiece, finite optical system, round fixed stage and 0.3 W LED illumination with rechargeable batteries (not supplied).

Slim and easy to carry, it is equipped with long lasting LED illumination to provide over 20 years of use.

Head: Monocular, 45° inclined; 360° rotating.

Eyepiece: WF10x/18 mm.

Nosepiece: Triple ball bearings revolving nosepiece, reversed.

Objectives:

- Achromatic 4x/0.10, W.D. 10.6 mm.
 - Achromatic 10x/0.25, W.D. 7.0 mm.
 - Achromatic 40x/0.65, W.D. 0.5 mm.
- All with anti-fungus treatment.

Specimen stage: X-Y moving and 360° rotating, 90 mm diameter, with sample clips.

Focusing: Separate coarse and fine focusing mechanism with limit stop to prevent the contact between objective and specimen.

Condenser: Diffusing filter with rotating diaphragm wheel.

Illumination: 0.3 W LED, with brightness control, rechargeable batteries. Color temperature: 6,300 K. Multi-plug 100-240Vac/5Vdc external power supply.

B-20CR



Cordless monocular microscope ideal for students and mainly primary schools, with achromatic lenses (400x), FN 18 eyepiece, finite optical system, coaxial focusing, mechanical stage and 0.5 W LED illumination with rechargeable batteries (not supplied).

Slim and easy to carry, it is equipped with all the main controls to start learning how to use an advanced microscope and with long lasting LED illumination to provide over 20 years of use.

Head: Monocular, 45° inclined; 360° rotating.

Eyepiece: WF10x/18 mm, secured by screw.

Nosepiece: Triple ball bearings revolving nosepiece, reversed.

Objectives:

- Achromatic 4x/0.10, W.D. 10.6 mm.
 - Achromatic 10x/0.25, W.D. 7.0 mm.
 - Achromatic 40x/0.65, W.D. 0.5 mm.
- All with anti-fungus treatment.

Specimen stage: Double layer, 105x95 mm, moving range 50x15 mm.

Focusing: Coaxial coarse and fine focusing mechanism with limit stop to prevent the contact between objective and specimen.

Condenser: N.A. 0.65 with iris diaphragm.

Illumination: 0.5 W LED, with brightness control, rechargeable batteries. Color temperature: 6,300 K. Multi-plug 100-240Vac/5Vdc external power supply.

M-100FLed



Cordless monocular microscope ideal for students and mainly primary schools, with achromatic lenses (400x), FN 18 eyepiece, finite optical system, coaxial focusing, fixed stage and 0.5 W LED illumination with rechargeable batteries (not supplied).

Slim and easy to carry, it is equipped with long lasting LED illumination to provide over 20 years of use.

Head: Monocular, 45° inclined; 360° rotating.

Eyepiece: WF10x/18 mm, secured by screw.

Nosepiece: Triple ball bearings revolving nosepiece.

Objectives:

- Achromatic 4x/0.10, W.D. 10.6 mm.
 - Achromatic 10x/0.25, W.D. 7.0 mm.
 - Achromatic 40x/0.65, W.D. 0.5 mm.
- All with anti-fungus treatment.

Specimen stage: Fixed stage, 120x110 mm, with sample clips.

Focusing: Separate coarse and fine focusing mechanism with limit stop to prevent the contact between objective and specimen.

Condenser: N.A. 0.65 with iris diaphragm.

Illumination: 0.5 W LED, with brightness control, rechargeable batteries. Color temperature: 6,300 K. Multi-plug 100-240Vac/5Vdc external power supply.

ECOVISION Series - Comparison chart

Model	Head	Eyepieces	Nosepiece	Objectives	Stage	Focusing	Condenser	Illumination
B-20R	Monocular, 45° inclined, 360° rotating	WF 10x/18	Triple, reversed	Achromatic 4x, 10x, 40x	X-Y moving, 360° rotating, 90 mm diameter, with sample clips	Separate coarse and fine	Diffusing filter with rotating diaphragm wheel	0.3 W LED, with brightness control, rechargeable batteries
B-20CR	Monocular, 45° inclined, 360° rotating	WF 10x/18	Triple, reversed	Achromatic 4x, 10x, 40x	Double layer, 105x95 mm, moving range 50x15 mm	Coaxial coarse and fine	N.A. 0.65, with iris diaphragm	0.5 W LED, with brightness control, rechargeable batteries
M-100FLed	Monocular, 45° inclined, 360° rotating	WF 10x/18	Triple	Achromatic 4x, 10x, 40x	Fixed, 120x110 mm, with sample clips	Separate coarse and fine	N.A. 0.65, with iris diaphragm	0.5 W LED, with brightness control, rechargeable batteries



ECOVISION Series - Zoom comparison



Ascaris female - 4x objective

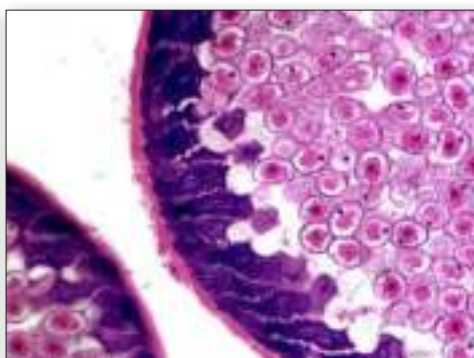

Ascaris female - 10x objective

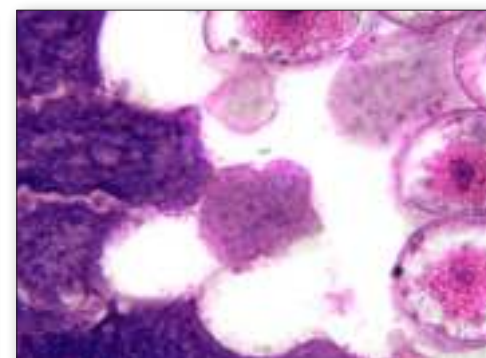

Ascaris female - 40x objective

ECOVISION Series - Accessories

1

Educational

ACCESSORIES FOR B-20R / B-20CR

Eyecups & Eyepieces

M-002.2	WF10x/18 eyepiece (23mm Ø)
M-003.2	WF15x/12 eyepiece (23mm Ø)
M-004.2	WF10x/18 micrometric eyepiece (23mm Ø)
M-008.2	WF10x/18 eyepiece, pointer (23mm Ø)
M-162	WF20x/10 eyepiece (23mm Ø)

Additional Lenses

M-114	0.35x C-Mount projection lens
M-115	0.5x C-Mount projection lens
M-118	0.75x C-Mount projection lens

Miscellaneous

15104	Cleaning kit
M-005	Micrometric slide, 26x76mm, 2 scales (1mm/100 & 10mm/100)
M-069	Solar charger
DC-001	Plastic dust cover, small, 340(l)x400(h) mm
AB-010	Antibacterial surface treatment, only for newly purchased microscope

M-069 - Solar charger

Included battery: rechargeable – Lithium-Poly. Capacity: 2500 mAh.
Output voltage: 5 Vdc. -
Autonomy: over 6 hours at medium intensity (X-LED³).
Charging models: with solar panel (12h),
with external USB power supply (2.5h).

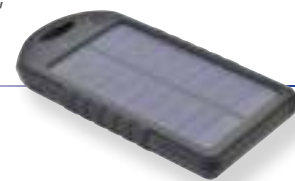

ACCESSORIES FOR M-100FLed

Eyecups & Eyepieces

M-001	Huygens 5x eyepiece (23mm Ø)
M-002.2	WF10x/18 eyepiece (23mm Ø)
M-004.2	WF10x/18 micrometric eyepiece (23mm Ø)
M-008.2	WF10x/18 eyepiece, pointer (23mm Ø)
M-003.2	WF15x/12 eyepiece (23mm Ø)
M-162	WF20x/10 eyepiece (23mm Ø)

Objectives

M-131	Achromatic objective 4x/0.10
M-132	Achromatic objective 10x/0.25
M-133	Achromatic objective 20x/0.40
M-134	Achromatic objective 40x/0.65
M-135	Achromatic objective 60x/0.85
M-136	Achromatic objective 100x/1.25 (oil)

Camera Adapters

M-115	0.35x C-Mount projection lens
M-114	0.5x C-Mount projection lens
M-118	0.75x C-Mount projection lens

Stages

M-040	0.5x C-Mount projection lens
-------	------------------------------

Condensers & Filters

M-099	Polarising set (filters and rotating stage)
-------	---

Miscellaneous

15008	Immersion oil, 10ml
15009	Immersion oil, 100ml
15104	Cleaning kit
DC-001	Plastic dust cover, small, 340(l)x400(h) mm
M-005	Micrometric slide, 26x76mm, 2 scales (1mm/100 & 10mm/100)
M-069	Solar charger
AB-010	Antibacterial surface treatment, only for newly purchased microscope

15104 - Cleaning kit

It cleans glass quickly and effectively, without leaving residue or odor. Ideal for precision lens or prism cleaning.



How to connect the cameras to our microscopes.

Please refer to the Adapter reference list on Digital section.

v 7.5 - OPTIKA reserves the right to make corrections, modifications, enhancements, improvements and other changes to its products at any time without notice.

Headquarters and Manufacturing Facilities

OPTIKA® S.r.l. Via Rigla, 30 - 24010 Ponteranica (BG) - ITALY - Tel.: +39 035.571.392 - info@optikamicroscopes.com

Optika Sales branches

OPTIKA® Spain spain@optikamicroscopes.com
OPTIKA® China china@optikamicroscopes.com
OPTIKA® India india@optikamicroscopes.com

OPTIKA® North America namerica@optikamicroscopes.com
OPTIKA® Central America camerica@optikamicroscopes.com
OPTIKA® Africa africa@optikamicroscopes.com

OPTIKA[®]
M I C R O S C O P E S
I T A L Y

B-60 Series



Entry-Level Biological Microscopes For Students

Cordless Educational Microscopes, Ideal To Start Exploring

PERFECT FOR STUDENT'S FIRST EXPERIENCES

- » Designed for novice users (students and primary schools especially)
- » Easy to handle, also by the youngest users
- » Longlife LED illumination (providing over 20 years of use)
- » Compact, practical and intuitive to use
- » Sturdy and durable for extended lifetime

COMFORTABLE, INTUITIVE & RELIABLE SOLUTIONS

- » 18 mm field number for a wide extended observation area
- » StagErase™ erasable stage to reduce scratches
- » Arm/wrist rest support to reduce the fatigue during use
- » Cordless use, totally independent from mains/batteries connection
- » External power supply for enhanced safety and convenient servicing



B-60 Series

A wide range of cordless, modern microscopes ideal for students and mainly primary schools with achromatic lenses, FN 18 eyepieces, finite optical system, coaxial focusing, StagErase™ erasable fixed or mechanical stage and 1 W LED illumination with rechargeable batteries (not provided). Slim and easy to carry, all the models are equipped with arm/wrist rest support to reduce the fatigue during use and long lasting LED illumination to provide over 20 years of use



Arm/wrist rest support to reduce the fatigue during use

Students get relaxed and stay relaxed when using the microscope! Effective in preventing fatigue during operation, increasing the ergonomics and the performance as a result

StagErase™ erasable stage to remove scratches

Here's something you've never seen before! This new, revolutionary stage is coated with a special painting to reduce accidental scratches to the minimum and facilitate their removal

Cordless use, totally independent from mains/batteries connection

All models work with or without the batteries in place and are for outdoor use (4-hour autonomy, at medium intensity)

External power supply for enhanced safety and convenient servicing

OPTIKA's safety first approach drives to the use of a low voltage multi-plug, external power supply in order to prevent any risk of electric shock and heatflow inside the unit

Longlife LED illumination (providing over 20 years of use)

Money & energy saving thanks to LED long lifetime (65.000 hours, 22 years in case of 8 hours/day) which is more than 20 times compared to a standard halogen bulb



B-61



Cordless, modern monocular microscope ideal for students and mainly primary schools with achromatic lenses (400x), FN 18 eyepiece, finite optical system, coaxial focusing, StagErase™ fixed stage and 1 W LED illumination with rechargeable batteries (not supplied).

Slim and easy to carry, it is equipped with arm/wrist rest support to reduce the fatigue during use and long lasting LED illumination to provide over 20 years of use.

Head: Monocular, 45° inclined; 360° rotating.

Eyepiece: WF10x/18 mm, secured by screw.

Nosepiece: Quadruple ball bearings revolving nosepiece, reversed.

Objectives:

- Achromatic 4x/0.10, W.D. 10.6 mm.
 - Achromatic 10x/0.25, W.D. 7.0 mm.
 - Achromatic 40x/0.65, W.D. 0.5 mm.
- All with anti-fungus treatment.

Specimen stage: StagErase™ erasable fixed stage, 120x110 mm, with sample clips.

Focusing: Coaxial coarse and fine focusing mechanism with limit stop to prevent the contact between objective and specimen.

Condenser: N.A. 0.65 with iris diaphragm.

Illumination: 1 W LED, with brightness control, rechargeable batteries. Color temperature: 6,300 K. Multi-plug 100-240Vac/5Vdc external power supply.

B-62



Cordless, modern monocular microscope ideal for students and mainly primary schools with achromatic lenses (400x), FN 18 eyepiece, finite optical system, coaxial focusing, StagErase™ mechanical stage, Abbe condenser and 1 W LED illumination with rechargeable batteries (not supplied).

Slim and easy to carry, it is equipped with arm/wrist rest support to reduce the fatigue during use and long lasting LED illumination to provide over 20 years of use.

Head: Monocular, 45° inclined; 360° rotating.

Eyepiece: WF10x/18 mm, secured by screw.

Nosepiece: Quadruple ball bearings revolving nosepiece, reversed.

Objectives:

- Achromatic 4x/0.10, W.D. 10.6 mm.
 - Achromatic 10x/0.25, W.D. 7.0 mm.
 - Achromatic 40x/0.65, W.D. 0.5 mm.
- All with anti-fungus treatment.

Specimen stage: StagErase™ erasable mechanical stage, 125x125 mm, 62x24 mm X-Y movement range. Vernier scale on the two axes, accuracy: 0.1 mm.

Focusing: Coaxial coarse and fine focusing mechanism with limit stop to prevent the contact between objective and specimen.

Condenser: Abbe N.A. 1.25, pre-centered, focusable, with iris diaphragm.

Illumination: 1 W LED, with brightness control, rechargeable batteries. Color temperature: 6,300 K. Multi-plug 100-240Vac/5Vdc external power supply.

B-63



Cordless, modern monocular microscope ideal for students and mainly primary schools with achromatic lenses (600x), FN 18 eyepiece, finite optical system, coaxial focusing, StagErase™ mechanical stage, Abbe condenser and 1 W LED illumination with rechargeable batteries (not supplied). Slim and easy to carry, it is equipped with arm/wrist rest support to reduce the fatigue during use and long lasting LED illumination to provide over 20 years of use.

Head: Monocular, 45° inclined; 360° rotating.

Eyepiece: WF10x/18 mm, secured by screw.

Nosepiece: Quadruple ball bearings revolving nosepiece, reversed.

Objectives:

- Achromatic 4x/0.10, W.D. 10.6 mm.
- Achromatic 10x/0.25, W.D. 7.0 mm.
- Achromatic 40x/0.65, W.D. 0.5 mm.
- Achromatic 60x/0.85, W.D. 0.13 mm.

All with anti-fungus treatment

Specimen stage: StagErase™ erasable mechanical stage, 125x125 mm, 62x24 mm X-Y movement range. Vernier scale on the two axes, accuracy: 0.1 mm.

Focusing: Coaxial coarse and fine focusing mechanism with limit stop to prevent the contact between objective and specimen.

Condenser: Abbe N.A. 1.25, pre-centered, focusable, with iris diaphragm.

Illumination: 1 W LED, with brightness control, rechargeable batteries. Color temperature: 6,300 K. Multi-plug 100-240Vac/5Vdc external power supply.

B-65



Cordless, modern monocular microscope ideal for students and mainly primary schools with achromatic lenses (1000x), FN 18 eyepiece, finite optical system, coaxial focusing, StagErase™ mechanical stage, Abbe condenser and 1 W LED illumination with rechargeable batteries (not supplied). Slim and easy to carry, it is equipped with arm/wrist rest support to reduce the fatigue during use and long lasting LED illumination to provide over 20 years of use.

Head: Monocular, 45° inclined; 360° rotating.

Eyepiece: WF10x/18 mm, secured by screw.

Nosepiece: Quadruple ball bearings revolving nosepiece, reversed.

Objectives:

- Achromatic 4x/0.10, W.D. 10.6 mm.
- Achromatic 10x/0.25, W.D. 7.0 mm.
- Achromatic 40x/0.65, W.D. 0.5 mm.
- Achromatic 100x/1.25 (Oil), W.D. 0.13 mm.

All with anti-fungus treatment.

Specimen stage: StagErase™ erasable mechanical stage, 125x125 mm, 62x24 mm X-Y movement range. Vernier scale on the two axes, accuracy: 0.1 mm.

Focusing: Coaxial coarse and fine focusing mechanism with limit stop to prevent the contact between objective and specimen.

Condenser: Abbe N.A. 1.25, pre-centered, focusable, with iris diaphragm.

Illumination: 1 W LED, with brightness control, rechargeable batteries. Color temperature: 6,300 K. Multi-plug 100-240Vac/5Vdc external power supply.

B-60 Series - Models

B-66



Cordless, modern binocular microscope ideal for students and mainly primary schools with achromatic lenses (400x), FN 18 eyepieces, finite optical system, coaxial focusing, StagErase™ mechanical stage, Abbe condenser and 1 W LED illumination with rechargeable batteries (not supplied). Slim and easy to carry, it is equipped with arm/wrist rest support to reduce the fatigue during use and long lasting LED illumination to provide over 20 years of use.

Head: Binocular, 30° inclined; 360° rotating.

Dioptic adjustment: Left eyepiece.

Eyepiece: WF10x/18 mm, secured by screw

Nosepiece: Quadruple ball bearings revolving nosepiece, reversed.

Objectives:

- Achromatic 4x/0.10, W.D. 10.6 mm.

- Achromatic 10x/0.25, W.D. 7.0 mm.

- Achromatic 40x/0.65, W.D. 0.5 mm.

All with anti-fungus treatment.

Specimen stage: StagErase™ erasable mechanical stage, 125x125 mm, 62x24 mm X-Y movement range. Vernier scale on the two axes, accuracy: 0.1 mm.

Focusing: Coaxial coarse and fine focusing mechanism with limit stop to prevent the contact between objective and specimen.

Condenser: Abbe N.A. 1.25, pre-centered, focusable, with iris diaphragm.

Illumination: 1 W LED, with brightness control, rechargeable batteries. Color temperature: 6,300 K. Multi-plug 100-240Vac/5Vdc external power supply.

B-67



Cordless, modern binocular microscope ideal for students and mainly primary schools with achromatic lenses (600x), FN 18 eyepieces, finite optical system, coaxial focusing, StagErase™ mechanical stage, Abbe condenser and 1 W LED illumination with rechargeable batteries (not supplied). Slim and easy to carry, it is equipped with arm/wrist rest support to reduce the fatigue during use and long lasting LED illumination to provide over 20 years of use.

Head: Binocular, 30° inclined; 360° rotating.

Dioptic adjustment: Left eyepiece.

Eyepiece: WF10x/18 mm, secured by screw

Nosepiece: Quadruple ball bearings revolving nosepiece, reversed.

Objectives:

- Achromatic 4x/0.10, W.D. 10.6 mm.

- Achromatic 10x/0.25, W.D. 7.0 mm.

- Achromatic 40x/0.65, W.D. 0.5 mm.

- Achromatic 60x/0.85, W.D. 0.13 mm.

All with anti-fungus treatment.

Specimen stage: StagErase™ erasable mechanical stage, 125x125 mm, 62x24 mm X-Y movement range. Vernier scale on the two axes, accuracy: 0.1 mm.

Focusing: Coaxial coarse and fine focusing mechanism with limit stop to prevent the contact between objective and specimen.

Condenser: Abbe N.A. 1.25, pre-centered, focusable, with iris diaphragm.

Illumination: 1 W LED, with brightness control, rechargeable batteries. Color temperature: 6,300 K. Multi-plug 100-240Vac/5Vdc external power supply.

B-60 Series - Models

1

Educational

B-69

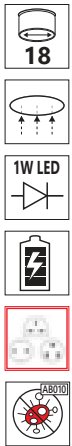

Cordless, modern binocular microscope ideal for students and mainly primary schools with achromatic lenses (1000x), FN 18 eyepieces, finite optical system, coaxial focusing, StagErase™ mechanical stage, Abbe condenser and 1 W LED illumination with rechargeable batteries (not supplied). Slim and easy to carry, it is equipped with arm/wrist rest support to reduce the fatigue during use and long lasting LED illumination to provide over 20 years of use.

Head: Binocular, 30° inclined; 360° rotating.
Dioptric adjustment: Left eyepiece.

Eyepiece: WF10x/18 mm, secured by screw

Nosepiece: Quadruple ball bearings revolving nosepiece, reversed.

Objectives:

- Achromatic 4x/0.10, W.D. 10.6 mm.
 - Achromatic 10x/0.25, W.D. 7.0 mm.
 - Achromatic 40x/0.65, W.D. 0.5 mm.
 - Achromatic 100x/1.25 (Oil), W.D. 0.13 mm.
- All with anti-fungus treatment.

Specimen stage: StagErase™ erasable mechanical stage, 125x125 mm, 62x24 mm X-Y movement range. Vernier scale on the two axes, accuracy: 0.1 mm.

Focusing: Coaxial coarse and fine focusing mechanism with limit stop to prevent the contact between objective and specimen.

Condenser: Abbe N.A. 1.25, pre-centered, focusable, with iris diaphragm.

Illumination: 1 W LED, with brightness control, rechargeable batteries.
Color temperature: 6,300 K. Multi-plug 100-240Vac/5Vdc external power supply.

Digital Video Bundles



Two models of the B-60 series can be equipped with a camera and a 7" LCD screen, both in high definition. In these bundles, the normal head (supplied with the instrument) can be replaced with the digital system in a few minutes. This solution provides a system suitable for viewing specimens by several students at the same time, without removing the possibility of using the microscope in the classical way through the eyepiece.

LCD screen: High definition 7" LCD.

Camera: 1920x1080 pixels, 30fps (video). Up to 1844x1080 pixels (photo).

Storing capacity: On Micro Sd card

Video recording: Yes

Measuring function: Yes, simple line measurement

Models available:

-B-61V: Same features than standard B-61, but delivered as bundle together with the 7" screen with built in camera. **Optical head with eyepiece included.**

-B-62V: Same features than standard B-62, but delivered as bundle together with the 7" screen with built in camera. **Optical head with eyepiece included.**

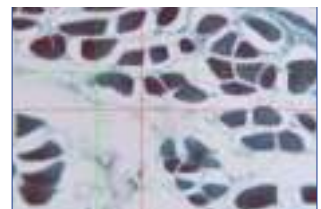

B-60 Series - Comparison chart

Model	Head	Eyepiece(s)	Nosepiece	Objectives	Stage	Focusing	Condenser	Illuminator
B-61	Monocular, 360° rotating, 45° inclined	Wide Field 10x/18mm	Quadruple, reversed	Achromatic 4x, 10x, 40x	Fixed, 120x110 mm	Coaxial coarse and fine focusing	N.A. 0.65 with iris diaphragm	1 W LED, brightness control, rechargeable batteries
B-62	Monocular, 360° rotating, 45° inclined	Wide Field 10x/18mm	Quadruple, reversed	Achromatic 4x, 10x, 40x	Mechanical, 125x125 mm with 62x24 mm X-Y moving range	Coaxial coarse and fine focusing	N.A. 1.25 Abbe type with iris diaphragm	1 W LED, brightness control, rechargeable batteries
B-63	Monocular, 360° rotating, 45° inclined	Wide Field 10x/18mm	Quadruple, reversed	Achromatic 4x, 10x, 40x, 60x	Mechanical, 125x125 mm with 62x24 mm X-Y moving range	Coaxial coarse and fine focusing	N.A. 1.25 Abbe type with iris diaphragm	1 W LED, brightness control, rechargeable batteries
B-65	Monocular, 360° rotating, 45° inclined	Wide Field 10x/18mm	Quadruple, reversed	Achromatic 4x, 10x, 40x, 100x (oil)	Mechanical, 125x125 mm with 62x24 mm X-Y moving range	Coaxial coarse and fine focusing	N.A. 1.25 Abbe type with iris diaphragm	1 W LED, brightness control, rechargeable batteries
B-66	Binocular, 360° rotating, 30° inclined	Wide Field 10x/18mm	Quadruple, reversed	Achromatic 4x, 10x, 40x	Mechanical, 125x125 mm with 62x24 mm X-Y moving range	Coaxial coarse and fine focusing	N.A. 1.25 Abbe type with iris diaphragm	1 W LED, brightness control, rechargeable batteries
B-67	Binocular, 360° rotating, 30° inclined	Wide Field 10x/18mm	Quadruple, reversed	Achromatic 4x, 10x, 40x, 60x	Mechanical, 125x125 mm with 62x24 mm X-Y moving range	Coaxial coarse and fine focusing	N.A. 1.25 Abbe type with iris diaphragm	1 W LED, brightness control, rechargeable batteries
B-69	Binocular, 360° rotating, 30° inclined	Wide Field 10x/18mm	Quadruple, reversed	Achromatic 4x, 10x, 40x, 100x (oil)	Mechanical, 125x125 mm with 62x24 mm X-Y moving range	Coaxial coarse and fine focusing	N.A. 1.25 Abbe type with iris diaphragm	1 W LED, brightness control, rechargeable batteries

B-60 Series - Accessories

Eyepics & Eyepieces

- M-001 Huygens 5x eyepiece (23mm Ø)
- M-002.2 WF10x/18 eyepiece (23mm Ø)
- M-004.2 WF10x/18 micrometric eyepiece (23mm Ø)
- M-008.2 WF10x/18 eyepiece, pointer (23mm Ø)
- M-003.2 WF15x/12 eyepiece (23mm Ø)

Condensers & Filters

- M-155.2 Polarising set (filters only)

Camera Adapters

- M-115 0.35x C-Mount projection lens
- M-114 0.5x C-Mount projection lens
- M-118 0.75x C-Mount projection lens

Miscellaneous

- 15008 Immersion oil, 10ml
- 15009 Immersion oil, 100ml
- 15104 Cleaning kit
- DC-001 Plastic dust cover, small, 340(l)x400(h) mm
- M-005 Micrometric slide, 26x76mm, 2 scales (1mm/100 & 10mm/100)
- M-069 Solar charger
- M-970 Plane-concave mirror, with base (only for B-61)
- AB-010 Antibacterial surface treatment, only for newly purchased microscope

15104 - Cleaning kit

It cleans glass quickly and effectively, without leaving residue or odor. Ideal for precision lens or prism cleaning.



M-069 - Solar charger

Included battery: rechargeable – Lithium-Poly. Capacity: 2500 mAh. Output voltage: 5 Vdc. - Autonomy: over 6 hours at medium intensity (X-LED³). Charging models: with solar panel (12h), with external USB power supply (2.5h)



How to connect the cameras to our microscopes.

Please refer to the Adapter reference list on Digital section.

v 7.5 - OPTIKA reserves the right to make corrections, modifications, enhancements, improvements and other changes to its products at any time without notice.

Headquarters and Manufacturing Facilities

OPTIKA® S.r.l. Via Rigla, 30 - 24010 Ponteranica (BG) - ITALY - Tel.: +39 035.571.392 - info@optikamicroscopes.com

Optika Sales branches

OPTIKA® Spain spain@optikamicroscopes.com
OPTIKA® China china@optikamicroscopes.com
OPTIKA® India india@optikamicroscopes.com

OPTIKA® North America namerica@optikamicroscopes.com
OPTIKA® Central America camerica@optikamicroscopes.com
OPTIKA® Africa africa@optikamicroscopes.com

OPTIKA[®]
M I C R O S C O P E S
I T A L Y

B-150 Series



Middle-Level Biological Microscopes For Students

The Most Comprehensive Series Dedicated To Students

A VARIETY OF CONFIGURATIONS TO MEET EVERY NEEDS

- » Designed to fulfill primary/secondary schools and educational labs
- » 18 mm field number for a wide observation area
- » Cordless use, totally independent from mains/battery connection (R-PL Line)
- » Sturdy and durable for extended lifetime; compact and intuitive
- » External power supply for enhanced safety and convenient servicing



PROFESSIONAL FEATURES FOR... WELL, EVERYONE

- » High eyepoint eyepieces for glasses wearers
- » N-PLAN objectives for a total field flatness on 18 mm (R-PL Line)
- » Li-ion battery for unparalleled duration & fast recharge (R-PL Line)
- » Automatic light control to forget manual adjustment (ALC Line)
- » Simple polarization versions with polarizer and analyzer (P Line)



Inventors Of A New Way To Teach Microscopy

100X OIL/WATER OBJECTIVE - ONLY AVAILABLE AT OPTIKA

- » Same objective for oil and water use
- » Oil represents the best media for high numerical aperture
- » Water combines results with convenience for educational purposes
- » Save time - forget about tedious cleaning and maintenance
- » Save money - no additional expenses due to inappropriate cleaning

100x Oil

100x Water

X-LED¹ FOR 65,000 HOURS OF OPERATION - ONLY AVAILABLE AT OPTIKA

- » State-of-the-art illumination system for incomparable light intensity
- » Exclusive lens & collector design, unmatched uniformity & brightness
- » Excellent color fidelity, constant pure-white color temperature
- » Money & energy saving, cutting electricity bills by 90%
- » Simple polarization versions with polarizer and analyzer (P Line)

Halogen

X-LED¹



Multi-plug power supply

Plenty Of Smart & Innovative Light-Related Technologies

AUTOMATIC LIGHT CONTROL - ONLY AVAILABLE AT OPTIKA (ALC LINE)

- » Choose the light intensity according to your preference
- » Press the ALC button and the light will be automatically re-adjusted
- » When another objective is used
- » When the diaphragm aperture changes
- » When processing samples with different opacity

STEP 1

Set the brightness according to your preferences.



STEP 2

Press the ALC button to save the brightness level.



STEP 3

Forget about the illumination!

The microscope will automatically adjust the brightness for you, in case of:

- Another objective is used
- The diaphragm aperture is changed
- Another specimen with different opacity is processed



Regulation of diaphragm aperture

Plenty Of Smart & Innovative Light-Related Technologies

1

Educational

LI-ION BATTERIES PROS (on B-150R models):

- » **Reliable:** Significantly lower self-discharge rate than NiMH
- » **Faster recharge:** Li-Ions can be charged in about 6 hours
- » **Number of charges:** approx. 2,000 times (+100% than NiMH batteries)
- » **No "memory effect":** can be charged at any time, without effects
- » Temperature tolerance to low temperature (more than NiMH batteries)





B-150 Series

A very comprehensive range of modern microscopes ideal for students and primary/secondary schools, available in brightfield or polarized light. Provided with achromatic or PLAN achromatic lenses, FN 18 high eyepoint eyepieces, finite optical system, coaxial focusing, fixed or mechanical stage and powerful, uniform, white color temperature 1 W X-LED1 illumination.

Slim and easy to carry, all the models are equipped with all the main controls to start learning how to use an advanced microscope and with long lasting LED illumination to provide over 20 years of use

A variety of configurations to meet every needs

Configurations for every taste, including regular brightfield and the one ready for polarization analysis (P Line), automatic light control (ALC Line), with built-in cameras for image acquisition (D Line) and cordless versions with advanced features (R-PL Models)

High eyepoint eyepieces for glasses wearers

These eyepieces are designed in such a way that the exit pupil is further away from the eye lens than standard eyepieces, being are well suited for eyeglasses wearers

X-LED¹ - State-of-the-art illumination system for incomparable light intensity

Provided with an exclusive lens & collector design, OPTIKA X-LED technology ensures unmatched uniformity & brightness (more than a 20 W halogen lamp) for excellent color fidelity with constant pure-white color temperature





100x oil/water objective: same objective for dual use

This new, revolutionary objective is something you've never seen before! Oil ensures the best performance achievable; water represents the most convenient solution as eliminates tedious cleaning

Incomparable comfort with the exclusive Automatic Light Control (ALC Line)

Light intensity is automatically adjusted by the microscope: no matter if the aperture of the diaphragm changes, if another objective is used, and if the opacity of the sample is different...the microscope will set the light!



N-PLAN objectives combined with exclusive Li-ion battery (R-PL line)

Laboratory grade optics meets the latest technology in terms of battery, for unparalleled lifetime (2000 charges), extended autonomy (15 hours/charge) and incredibly fast recharging time (6 hours)

External power supply for enhanced safety and convenient servicing

OPTIKA's safety first approach drives to the use of a low voltage, multi-plug, external power supply in order to prevent any risk of electric shock and heatflow inside the unit

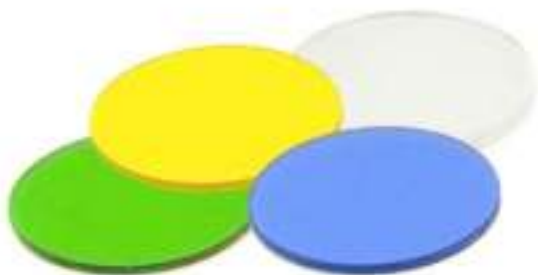

GET THE MOST OUT OF OUR ACCESSORIES

M-974 - Blue filter

Increase the colour temperature of light (toward the blue)

M-976 - Green filter

Optimize the resolution of phase contrast

M-978 - Yellow filter

Decrease the colour temperature of light (toward the red)

M-988 - Frosted glass filter

Increase the uniformity of illumination, even further

B-150 Series - Standard Models

B-151



Monocular microscope ideal for students and primary schools, with three achromatic lenses (400x), FN 18 high eyepoint eyepiece, finite optical system, coaxial focusing, fixed stage and powerful, uniform, white color temperature settable 1 W **X-LED** illumination.

Slim and easy to carry, the LED illumination will provide over 20 years of use.

Head: Monocular, 30° inclined; 360° rotating.

Eyepiece: WF10x/18 mm, high eyepoint, secured by screw.

Nosepiece: Quadruple ball bearings revolving nosepiece.

Objectives:

- Achromatic HC type 4x/0.10, W.D. 18 mm.
 - Achromatic HC type 10x/0.25, W.D. 7 mm.
 - Achromatic HC type 40x/0.65, W.D. 0.53 mm.
- All with anti-fungus treatment.

Specimen stage: Fixed stage, 130x120 mm. With sample clips.

Focusing: Coaxial coarse and fine focusing mechanism with limit stop to prevent the contact between objective and specimen. Adjustable tension of coarse focusing knob.

Condenser: N.A. 0.65, pre-centered, fixed with iris diaphragm.

Illumination: X-LED1 with white 1 W LED and brightness control. Color temperature: 6,300 K. Multi-plug 100-240Vac/5Vdc external power supply.

B-151ALC



Monocular microscope ideal for students and primary schools, with three achromatic lenses (400x), FN 18 high eyepoint eyepiece, finite optical system, coaxial focusing, fixed stage and powerful, uniform, white color temperature settable 1 W **X-LED** illumination. Slim and easy to carry, the LED illumination will provide over 20 years of use of use. The exclusive ALC will automatically adjust the brightness according to your preferences

Head: Monocular, 30° inclined; 360° rotating (when ALC cable is unplugged).

Eyepiece: WF10x/18 mm, high eyepoint, secured by screw.

Nosepiece: Quadruple ball bearings revolving nosepiece.

Objectives:

- Achromatic HC type 4x/0.10, W.D. 18 mm.
 - Achromatic HC type 10x/0.25, W.D. 7 mm.
 - Achromatic HC type 40x/0.65, W.D. 0.53 mm.
- All with anti-fungus treatment.

Specimen stage: Fixed stage, 130x120 mm. With sample clips.

Focusing: Coaxial coarse and fine focusing mechanism with limit stop to prevent the contact between objective and specimen. Adjustable tension of coarse focusing knob.

Condenser: N.A. 0.65, pre-centered, fixed with iris diaphragm.

Illumination: X-LED1 with white 1 W LED and brightness control. Color temperature: 6,300 K. With **ALC** for automatic light control. Multi-plug 100-240Vac/5Vdc external power supply.

B-150 Series - Standard Models

1

Educational

B-151R-PL



Cordless monocular microscope ideal for students and primary schools, with three PLAN achromatic lenses (400x), FN 18 high eyepoint eyepiece, finite optical system, coaxial focusing, fixed stage and powerful, uniform, white color temperature 1 W **X-LED**¹ illumination. Slim and easy to carry, the LED illumination will provide over 20 years of use of use. The Li-Ion battery (not provided) ensures unparalleled duration and fast recharge.

Head: Monocular, 30° inclined; 360° rotating.

Eyepiece: WF10x/18 mm, secured by screw.

Nosepiece: Quadruple ball bearings revolving nosepiece.

Objectives:

- N-PLAN 4x/0.10, W.D. 15.2 mm.
 - N-PLAN 10x/0.25, W.D. 5.5 mm.
 - N-PLAN 40x/0.65, W.D. 0.45 mm.
- All with anti-fungus treatment.

Specimen stage: Fixed stage, 130x120 mm. With sample clips.

Focusing: Coaxial coarse and fine focusing mechanism with limit stop to prevent the contact between objective and specimen. Adjustable tension of coarse focusing knob.

Condenser: N.A. 0.65, pre-centered, fixed with iris diaphragm.

Illumination: X-LED¹ with white 1 W LED and light intensity control. Color temperature: 6,300 K. Li-Ion battery for long lasting operation. Multi-plug 100-240Vac/5Vdc external power supply.

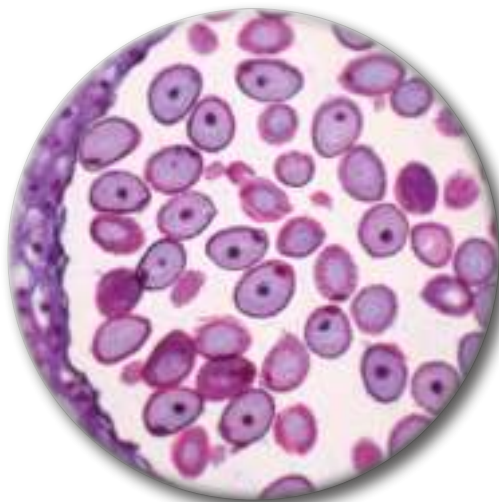

Lily Anther, Mature Pollen Grains, c.s
Conventional Achromatic Objective

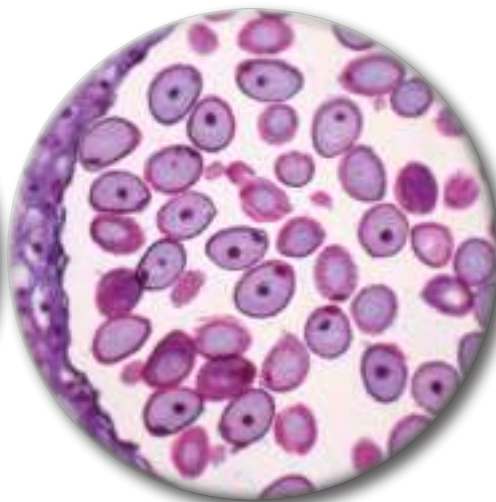

Lily Anther, Mature Pollen Grains, c.s
OPTIKA HC Objective

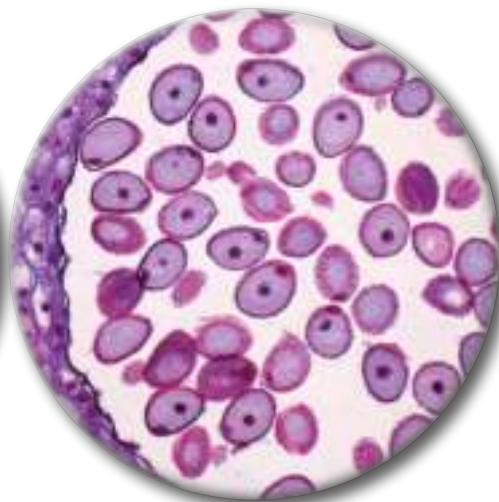

Lily Anther, Mature Pollen Grains, c.s
OPTIKA N-PLAN Objective



HC

N-PLAN

OPTIKA HC: This series of objectives ensures a versatile and reasonably priced entry-level solution for brightfield and simple polarization applications. They are specifically designed to achieve optimal contrast and thus maximize yield on an instrument intended for education on F.N. 18.

OPTIKA N-PLAN: In addition to the advantages of the HC objectives, the total flatness of the field and an even greater contrast are achieved with the N-PLAN series.

B-150 Series - Standard Models

B-152 / B-153



Monocular microscope ideal for students and primary schools, with four achromatic lenses (600x), FN 18 high eyepoint eyepiece, finite optical system, coaxial focusing, mechanical stage, Abbe condenser and powerful, uniform, white color temperature 1 W **X-LED¹** illumination. Slim and easy to carry, it is equipped with all the main controls to start learning how to use an advanced microscope and with long lasting LED illumination to provide over 20 years of use.

Head: Monocular, 30° inclined; 360° rotating.

Eyepiece: WF10x/18 mm, high eyepoint, secured by screw.

Nosepiece: Quadruple ball bearings revolving nosepiece.

Objectives:

- Achromatic HC type 4x/0.10, W.D. 18 mm.
 - Achromatic HC type 10x/0.25, W.D. 7 mm.
 - Achromatic HC type 40x/0.65, W.D. 0.53 mm.
 - **Achromatic HC type 60x/0.85, W.D. 0.45 mm (only in B-153 model).**
- All with anti-fungus treatment.

Specimen stage: Mechanical stage, 125x116 mm, 70x30 mm X-Y movement range. Vernier scale on the two axes, accuracy: 0.1 mm.

Focusing: Coaxial coarse and fine focusing mechanism with limit stop to prevent the contact between objective and specimen. Adjustable tension of coarse focusing knob.

Condenser: Abbe N.A. 1.25, pre-centered, focusable, with iris diaphragm.

Illumination: X-LED¹ with white 1 W LED and brightness control. Color temperature: 6,300 K. Multi-plug 100-240Vac/5Vdc external power supply.

B-152ALC / B-153ALC



Monocular microscope ideal for students and primary schools, with four achromatic lenses (600x), FN 18 high eyepoint eyepiece, finite optical system, coaxial focusing, mechanical stage, Abbe condenser and powerful, uniform, white color 1 W **X-LED¹**. Slim and easy to carry, equipped with all the main controls to start learning how to use an advanced microscope and with long lasting LED. The exclusive ALC will automatically adjust the brightness according to your preferences.

Head: Monocular, 30° inclined; 360° rotating (when ALC cable is unplugged).

Eyepiece: WF10x/18 mm, high eyepoint, secured by screw.

Nosepiece: Quadruple ball bearings revolving nosepiece.

Objectives:

- Achromatic HC type 4x/0.10, W.D. 18 mm.
 - Achromatic HC type 10x/0.25, W.D. 7 mm.
 - Achromatic HC type 40x/0.65, W.D. 0.53 mm.
 - **Achromatic HC type 60x/0.85 (only in B-153ALC model)**
- All with anti-fungus treatment.

Specimen stage: Mechanical stage, 125x116 mm, 70x30 mm X-Y movement range. Vernier scale on the two axes, accuracy: 0.1 mm.

Focusing: Coaxial coarse and fine focusing mechanism with limit stop to prevent the contact between objective and specimen. Adjustable tension of coarse focusing knob.

Condenser: Abbe N.A. 1.25, pre-centered, focusable, with iris diaphragm.

Illumination: X-LED¹ with white 1 W LED and brightness control. Color temperature: 6,300 K. With **ALC** for automatic light control. Multi-plug 100-240Vac/5Vdc external power supply.

B-150 Series - Standard Models

B-152R-PL / B-153R-PL



Cordless monocular microscope ideal for students and primary schools, with three or four PLAN achromatic lenses (400x on B-152R-PL or 600x on B-153R-PL), FN 18 high eyepoint eyepiece, finite optical system, coaxial focusing, mechanical stage, Abbe condenser and powerful, uniform, white color 1 W **X-LED¹**. Slim and easy to carry, it is equipped with all the main controls to start learning how to use an advanced microscope and with long lasting LED illumination. The Li-Ion battery (not provided) ensures unparalleled duration and fast recharge.

Head: Monocular, 30° inclined; 360° rotating.

Eyepiece: WF10x/18 mm, high eyepoint, secured by screw.

Nosepiece: Quadruple ball bearings revolving nosepiece.

Objectives:

- N-PLAN plan achromatic 4x/0.10, W.D. 15.2 mm.
 - N-PLAN plan achromatic 10x/0.25, W.D. 5.5 mm.
 - N-PLAN plan achromatic 40x/0.65, W.D. 0.45 mm.
 - N-PLAN plan achromatic 60x/0.85, W.D. 0.45 mm. (only for B-153R-PL).
- All with anti-fungus treatment.

Specimen stage: Mechanical stage, 125x116 mm, 70x30 mm X-Y movement range. Vernier scale on the two axes, accuracy: 0.1 mm.

Focusing: Coaxial coarse and fine focusing mechanism with limit stop to prevent the contact between objective and specimen. Adjustable tension of coarse focusing knob.

Condenser: Abbe N.A. 1.25, pre-centered, focusable, with iris diaphragm.

Illumination: X-LED¹ with white 1 W LED and brightness control. Color temperature: 6,300 K. Li-Ion battery for long lasting operation. Multi-plug 100-240Vac/5Vdc external power supply.

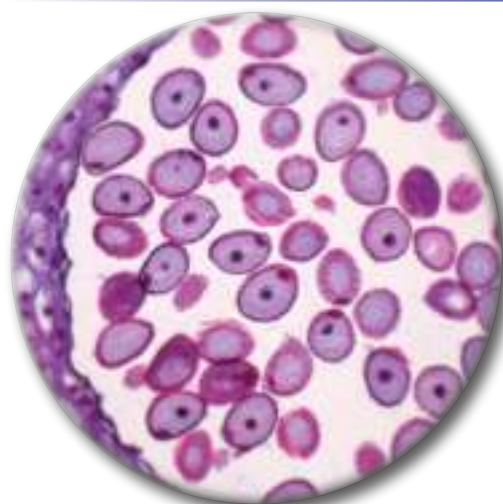

Lily Anther, Mature Pollen Grains, c.s.
Conventional Achromatic Objective

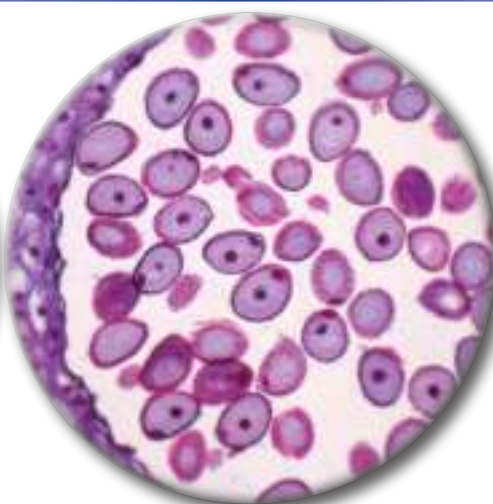

Lily Anther, Mature Pollen Grains, c.s.
OPTIKA HC Objective

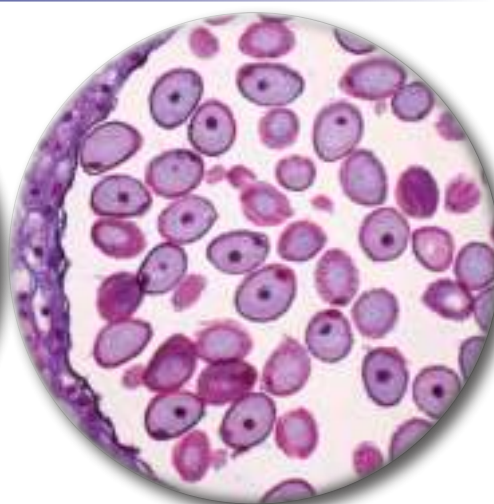

Lily Anther, Mature Pollen Grains, c.s.
OPTIKA N-PLAN Objective



HC

N-PLAN

OPTIKA HC: This series of objectives ensures a versatile and reasonably priced entry-level solution for brightfield and simple polarization applications. They are specifically designed to achieve optimal contrast and thus maximize yield on an instrument intended for education on F.N. 18.

OPTIKA N-PLAN: In addition to the advantages of the HC objectives, the total flatness of the field and an even greater contrast are achieved with the N-PLAN series.

B-150 Series - Standard Models

B-155

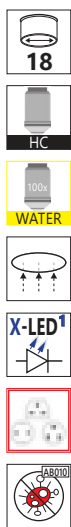

Monocular microscope ideal for students and primary schools, with four achromatic lenses (1000x), FN 18 high eyepoint eyepiece, finite optical system, coaxial focusing, mechanical stage, Abbe condenser and powerful, uniform, white color temperature 1 W **X-LED¹** illumination. Slim and easy to carry, it is equipped with all the main controls to start learning how to use an advanced microscope and with long lasting LED illumination to provide over 20 years of use.

Head: Monocular, 30° inclined; 360° rotating.

Eyepiece: WF10x/18 mm, high eyepoint, secured by screw.

Nosepiece: Quadruple ball bearings revolving nosepiece.

Objectives:

- Achromatic HC type 4x/0.10
 - Achromatic HC type 10x/0.25
 - Achromatic HC type 40x/0.65
 - Achromatic HC type 100x/1.25 (oil/water).
- All with anti-fungus treatment.

Specimen stage: Mechanical stage, 125x116 mm, 70x30 mm X-Y movement range. Vernier scale on the two axes, accuracy: 0.1 mm.

Focusing: Coaxial coarse and fine focusing mechanism with limit stop to prevent the contact between objective and specimen. Adjustable tension of coarse focusing knob.

Condenser: Abbe N.A. 1.25, pre-centered, focusable, with iris diaphragm.

Illumination: X-LED¹ with white 1 W LED and brightness control. Color temperature: 6,300 K. Multi-plug 100-240Vac/5Vdc external power supply.

B-155ALC

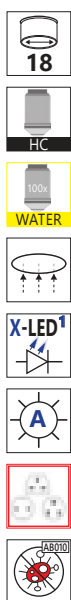

Monocular microscope ideal for students and primary schools, with four achromatic lenses (1000x), FN 18 high eyepoint eyepiece, finite optical system, coaxial focusing, mechanical stage, Abbe condenser and powerful, uniform, white color temperature 1 W **X-LED¹**. Slim and easy to carry, it is equipped with all the main controls to start learning how to use an advanced microscope with long lasting LED illumination. The ALC will automatically adjust the brightness according to your preferences.

Head: Monocular, 30° inclined; 360° rotating (when ALC cable is unplugged).

Eyepiece: WF10x/18 mm, high eyepoint, secured by screw.

Nosepiece: Quadruple ball bearings revolving nosepiece.

Objectives:

- Achromatic HC type 4x/0.10
 - Achromatic HC type 10x/0.25
 - Achromatic HC type 40x/0.65
 - Achromatic HC type 100x/1.25 (oil/water).
- All with anti-fungus treatment.

Specimen stage: Mechanical stage, 125x116 mm, 70x30 mm X-Y movement range. Vernier scale on the two axes, accuracy: 0.1 mm.

Focusing: Coaxial coarse and fine focusing mechanism with limit stop to prevent the contact between objective and specimen. Adjustable tension of coarse focusing knob.

Condenser: Abbe N.A. 1.25, pre-centered, focusable, with iris diaphragm.

Illumination: X-LED¹ with white 1 W LED and brightness control. Color temperature: 6,300 K. With **ALC** for automatic light control. Multi-plug 100-240Vac/5Vdc external power supply.

B-150 Series - Standard Models

B-155R-PL



Cordless monocular microscope ideal for students and primary schools, with four PLAN achromatic lenses (1000x), FN 18 high eyepoint eyepiece, finite optical system, coaxial focusing, mechanical stage, Abbe condenser and powerful, uniform, white color 1 W **X-LED¹**. Slim and easy to carry, equipped with all the main controls to start learning how to use an advanced microscope with long lasting LED illumination. The Li-Ion battery (not supplied) ensures unparalleled duration and fast recharge.

Head: Monocular, 30° inclined; 360° rotating.

Eyepiece: WF10x/18 mm, high eyepoint, secured by screw.

Nosepiece: Quadruple ball bearings revolving nosepiece.

Objectives:

- N-PLAN plan achromatic 4x/0.10, W.D. 18 mm.
 - N-PLAN plan achromatic 10x/0.25, W.D. 7 mm.
 - N-PLAN plan achromatic 40x/0.65, W.D. 0.53 mm.
 - N-PLAN plan achromatic 100x/1.25, W.D. 0.13 mm (oil/water).
- All with anti-fungus treatment.

Specimen stage: Mechanical stage, 125x116 mm, 70x30 mm X-Y movement range. Vernier scale on the two axes, accuracy: 0.1 mm.

Focusing: Coaxial coarse and fine focusing mechanism with limit stop to prevent the contact between objective and specimen. Adjustable tension of coarse focusing knob.

Condenser: Abbe N.A. 1.25, pre-centered, focusable, with iris diaphragm.

Illumination: X-LED¹ with white 1 W LED and brightness control. Color temperature: 6,300 K. Li-Ion battery for long lasting operation. Multi-plug 100-240Vac/5Vdc external power supply.

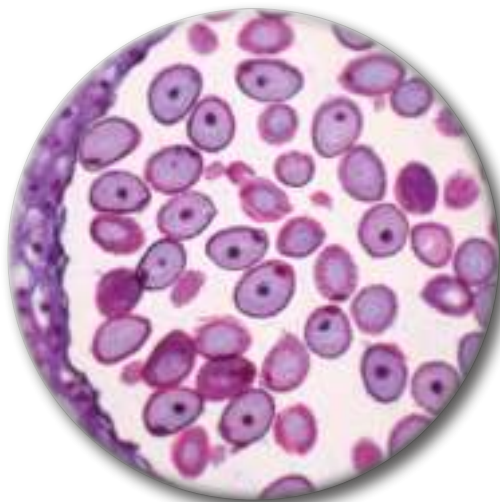

Lily Anther, Mature Pollen Grains, c.s
Conventional Achromatic Objective

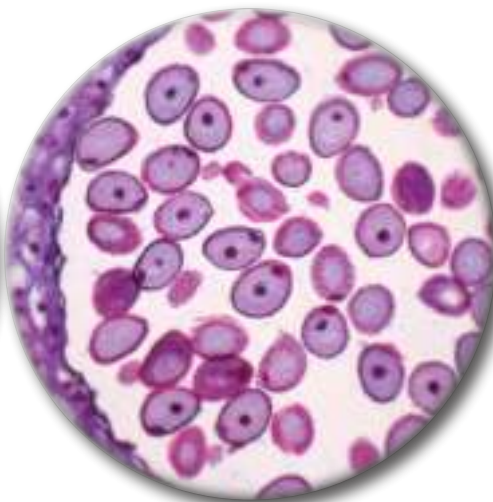

Lily Anther, Mature Pollen Grains, c.s
OPTIKA HC Objective

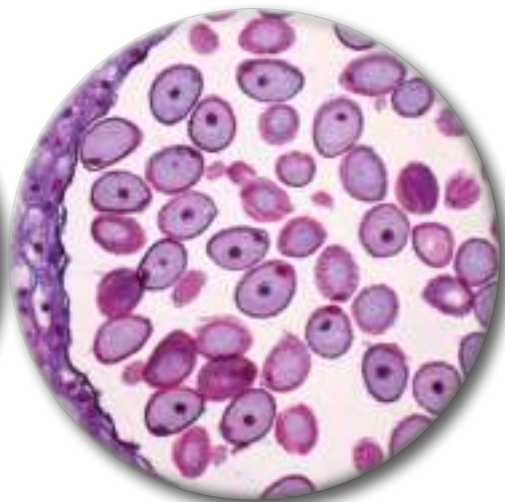

Lily Anther, Mature Pollen Grains, c.s
OPTIKA N-PLAN Objective



HC

N-PLAN

OPTIKA HC: This series of objectives ensures a versatile and reasonably priced entry-level solution for brightfield and simple polarization applications. They are specifically designed to achieve optimal contrast and thus maximize yield on an instrument intended for education on F.N. 18.

OPTIKA N-PLAN: In addition to the advantages of the HC objectives, the total flatness of the field and an even greater contrast are achieved with the N-PLAN series.

1 B-150 Series - Standard Models

Educational

B-156 / B-157



Binocular microscope ideal for students and primary schools, with four achromatic lenses (600x), FN 18 high eyepoint eyepieces, finite optical system, coaxial focusing, mechanical stage, Abbe condenser and powerful, uniform, white color temperature 1 W **X-LED¹** illumination. Slim and easy to carry, it is equipped with all the main controls to start learning how to use an advanced microscope and with long lasting LED illumination to provide over 20 years of use.

Head: Binocular, 30° inclined; 360° rotating.

Dioptric adjustment: Left eyepiece.

Eyepieces: WF10x/18 mm, high eyepoint, secured by screw.

Nosepiece: Quadruple ball bearings revolving nosepiece.

Objectives:

- Achromatic HC type 4x/0.10, W.D. 18 mm.
 - Achromatic HC type 10x/0.25, W.D. 7 mm.
 - Achromatic HC type 40x/0.65, W.D. 0.53 mm.
 - **Achromatic HC type 60x/0.85, W.D. 0.45 mm (only in B-157 model).**
- All with anti-fungus treatment.

Specimen stage: Mechanical stage, 125x116 mm, 70x30 mm X-Y movement range. Vernier scale on the two axes, accuracy: 0.1 mm.

Focusing: Coaxial coarse and fine focusing mechanism with limit stop to prevent the contact between objective and specimen. Adjustable tension of coarse focusing knob.

Condenser: Abbe N.A. 1.25, pre-centered, focusable, with iris diaphragm.

Illumination: X-LED¹ with white 1 W LED and brightness control. Color temperature: 6,300 K. Multi-plug 100-240Vac/5Vdc external power supply.

B-156ALC / B-157ALC



Binocular microscope ideal for students and primary schools, with four achromatic lenses (600x), FN 18 high eyepoint eyepieces, finite optical system, coaxial focusing, mechanical stage, Abbe condenser and powerful, uniform, white color temperature 1 W X-LED¹ illumination. Slim and easy to carry, it is equipped with all the main controls to start learning how to use an advanced microscope and with long lasting LED illumination to provide over 20 years of use. The exclusive **ALC** will automatically adjust the brightness according to your preferences.

Head: Binocular, 30° inclined; 360° rotating.

Dioptric adjustment: Left eyepiece.

Eyepieces: WF10x/18 mm, high eyepoint, secured by screw.

Nosepiece: Quadruple ball bearings revolving nosepiece.

Objectives:

- Achromatic HC type 4x/0.10, W.D. 18 mm.
 - Achromatic HC type 10x/0.25, W.D. 7 mm.
 - Achromatic HC type 40x/0.65, W.D. 0.53 mm.
 - **Achromatic HC type 60x/0.85, W.D. 0.45 mm (only in B-157ALC model).**
- All with anti-fungus treatment.

Specimen stage: Mechanical stage, 125x116 mm, 70x30 mm X-Y movement range. Vernier scale on the two axes, accuracy: 0.1 mm

Focusing: Coaxial coarse and fine focusing mechanism with limit stop to prevent the contact between objective and specimen. Adjustable tension of coarse focusing knob.

Condenser: Abbe N.A. 1.25, pre-centered, focusable, with iris diaphragm.

Illumination: X-LED¹ with white 1 W LED and brightness control. Color temperature: 6,300 K. With **ALC** for automatic light control. Multi-plug 100-240Vac/5Vdc external power supply.

B-150 Series - Standard Models

B-156R-PL / B-157R-PL



Cordless binocular microscope ideal for students and primary schools, with four PLAN achromatic lenses (600x), FN 18 high eyepoint eyepieces, finite optical system, coaxial focusing, mechanical stage, Abbe condenser and powerful, uniform, white color temperature 1 W **X-LED¹** illumination. Slim and easy to carry, it is equipped with all the main controls to start learning how to use an advanced microscope and with long lasting LED illumination to provide over 20 years of use. The Li-Ion battery ensures unparalleled duration and fast recharge.

Head: Binocular, 30° inclined; 360° rotating.

Dioptric adjustment: Left eyepiece.

Eyepieces: WF10x/18 mm, high eyepoint, secured by screw.

Nosepiece: Quadruple ball bearings revolving nosepiece.

Objectives:

- N-PLAN plan achromatic 4x/0.10, W.D. 15.2 mm.
- N-PLAN plan achromatic 10x/0.25, W.D. 5.5 mm.
- N-PLAN plan achromatic 40x/0.65, W.D. 0.45 mm.
- **N-PLAN plan achromatic 60x/0.85, W.D. 0.45 mm (only in B-157R-PL model).** All with anti-fungus treatment.

Specimen stage: Mechanical stage, 125x116 mm, 70x30 mm X-Y movement range. Vernier scale on the two axes, accuracy: 0.1 mm.

Focusing: Coaxial coarse and fine focusing mechanism with limit stop to prevent the contact between objective and specimen. Adjustable tension of coarse focusing knob.

Condenser: Abbe N.A. 1.25, pre-centered, focusable, with iris diaphragm.

Illumination: X-LED¹ with white 1 W LED and brightness control. Color temperature: 6,300 K. Li-Ion battery for long lasting operation. Multi-plug 100-240Vac/5Vdc external power supply.

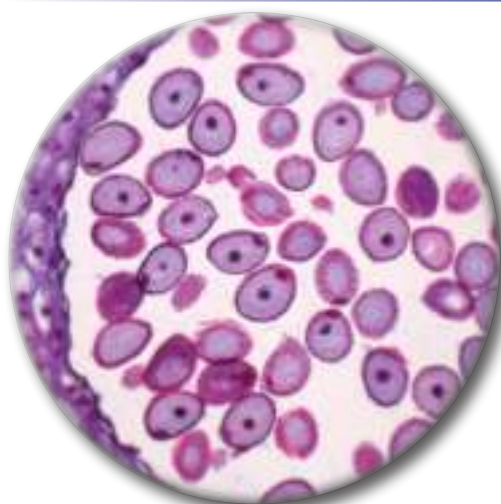

Lily Anther, Mature Pollen Grains, c.s.
Conventional Achromatic Objective

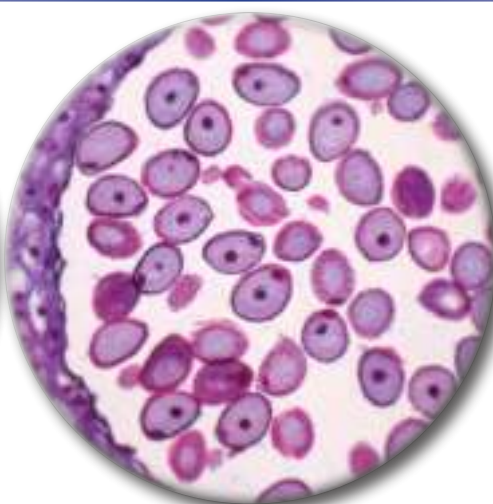

Lily Anther, Mature Pollen Grains, c.s.
OPTIKA HC Objective

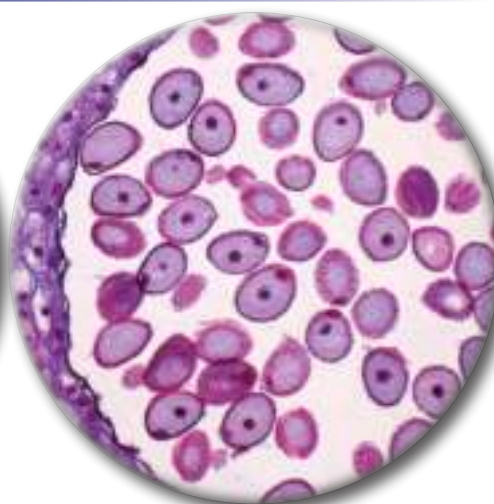

Lily Anther, Mature Pollen Grains, c.s.
OPTIKA N-PLAN Objective



HC

N-PLAN

OPTIKA HC: This series of objectives ensures a versatile and reasonably priced entry-level solution for brightfield and simple polarization applications. They are specifically designed to achieve optimal contrast and thus maximize yield on an instrument intended for education on F.N. 18.

OPTIKA N-PLAN: In addition to the advantages of the HC objectives, the total flatness of the field and an even greater contrast are achieved with the N-PLAN series.

B-150 Series - Standard Models

B-159

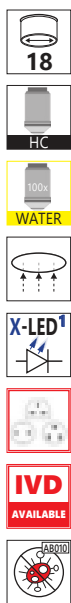

Binocular microscope ideal for students and primary schools, with four achromatic lenses (1000x), FN 18 high eyepoint eyepieces, finite optical system, coaxial focusing, mechanical stage, Abbe condenser and powerful, uniform, white color temperature 1 W **X-LED¹** illumination. Slim and easy to carry, it is equipped with all the main controls to start learning how to use an advanced microscope and with long lasting LED illumination to provide over 20 years of use.

Head: Binocular, 30° inclined; 360° rotating.

Dioptric adjustment: Left eyepiece.

Eyepieces: WF10x/18 mm, high eyepoint, secured by screw.

Nosepiece: Quadruple ball bearings revolving nosepiece.

Objectives:

- Achromatic HC type 4x/0.10, W.D. 18 mm.
 - Achromatic HC type 10x/0.25, W.D. 7 mm.
 - Achromatic HC type 40x/0.65, W.D. 0.53 mm.
 - Achromatic HC type 100x/1.25, W.D. 0.13 mm (oil/water).
- All with anti-fungus treatment.

Specimen stage: Mechanical stage, 125x116 mm, 70x30 mm X-Y movement range. Vernier scale on the two axes, accuracy: 0.1 mm.

Focusing: Coaxial coarse and fine focusing mechanism with limit stop to prevent the contact between objective and specimen. Adjustable tension of coarse focusing knob.

Condenser: Abbe N.A. 1.25, pre-centered, focusable, with iris diaphragm.

Illumination: X-LED¹ with white 1 W LED and brightness control. Color temperature: 6,300 K. Multi-plug 100-240Vac/5Vdc external power supply.

B-159ALC

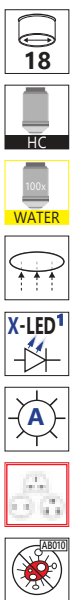

Binocular microscope ideal for students and primary schools, with four achromatic lenses (1000x), FN 18 high eyepoint eyepieces, finite optical system, coaxial focusing, mechanical stage, Abbe condenser and powerful, uniform, white color temperature 1 W X-LED¹ illumination. Slim and easy to carry, it is equipped with all the main controls to start learning how to use an advanced microscope and with long lasting LED illumination to provide over 20 years of use. The exclusive **ALC** will automatically adjust the brightness according to your preferences.

Head: Binocular, 30° inclined; 360° rotating (when ALC cable is unplugged).

Dioptric adjustment: Left eyepiece.

Eyepieces: WF10x/18 mm, high eyepoint, secured by screw.

Nosepiece: Quadruple ball bearings revolving nosepiece.

Objectives:

- Achromatic HC type 4x/0.10, W.D. 18 mm.
 - Achromatic HC type 10x/0.25, W.D. 7 mm.
 - Achromatic HC type 40x/0.65, W.D. 0.53 mm.
 - Achromatic HC type 100x/1.25, W.D. 0.13 mm (oil/water).
- All with anti-fungus treatment.

Specimen stage: Mechanical stage, 125x116 mm, 70x30 mm X-Y movement range. Vernier scale on the two axes, accuracy: 0.1 mm.

Focusing: Coaxial coarse and fine focusing mechanism with limit stop to prevent the contact between objective and specimen. Adjustable tension of coarse focusing knob.

Condenser: Abbe N.A. 1.25, pre-centered, focusable, with iris diaphragm.

Illumination: X-LED¹ with white 1 W LED and brightness control. Color temperature: 6,300 K. With **ALC** for automatic light control. Multi-plug 100-240Vac/5Vdc external power supply.

B-150 Series - Standard Models

B-159R-PL



Cordless binocular microscope ideal for students and primary schools, with four PLAN achromatic lenses (1000x), FN 18 high eyepoint eyepieces, finite optical system, coaxial focusing, mechanical stage, Abbe condenser and powerful, uniform, white color temperature 1 W **X-LED¹** illumination. Slim and easy to carry, it is equipped with all the main controls to start learning how to use an advanced microscope and with long lasting LED illumination to provide over 20 years of use. The Li-Ion battery (not provided) ensures unparalleled duration and fast recharge.

Head: Binocular, 30° inclined; 360° rotating.

Dioptric adjustment: Left eyepiece.

Eyepieces: WF10x/18 mm, high eyepoint, secured by screw.

Nosepiece: Quadruple ball bearings revolving nosepiece.

Objectives:

- N-PLAN plan achromatic 4x/0.10, W.D. 15.2 mm.
 - N-PLAN plan achromatic 10x/0.25, W.D. 5.5 mm.
 - N-PLAN plan achromatic 40x/0.65, W.D. 0.45 mm.
 - N-PLAN plan achromatic 100x/1.25, W.D. 0.13 mm (oil/water).
- All with anti-fungus treatment.

Specimen stage: Mechanical stage, 125x116 mm, 70x30 mm X-Y movement range. Vernier scale on the two axes, accuracy: 0.1 mm.

Focusing: Coaxial coarse and fine focusing mechanism with limit stop to prevent the contact between objective and specimen. Adjustable tension of coarse focusing knob.

Condenser: Abbe N.A. 1.25, pre-centered, focusable, with iris diaphragm.

Illumination: X-LED¹ with white 1 W LED and brightness control. Color temperature: 6,300 K. Li-Ion battery for long lasting operation. Multi-plug 100-240Vac/5Vdc external power supply.

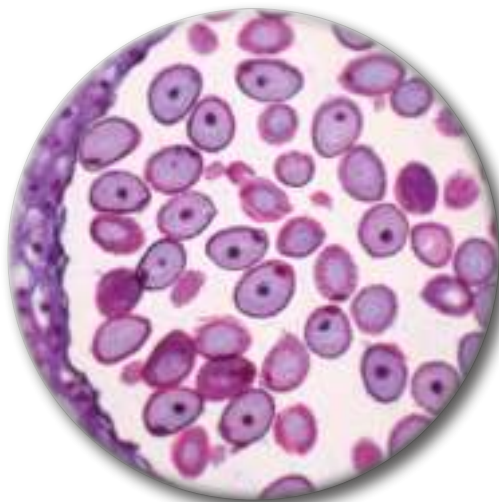

Lily Anther, Mature Pollen Grains, c.s
Conventional Achromatic Objective

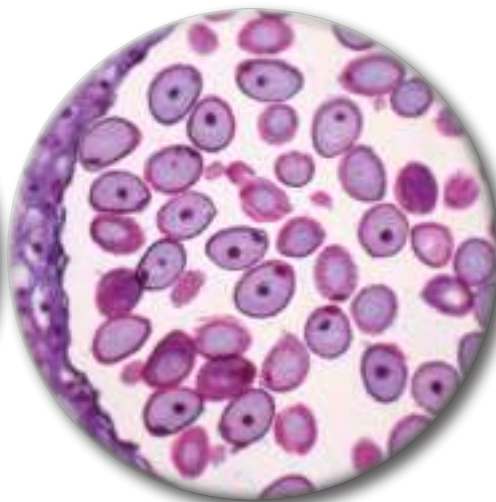

Lily Anther, Mature Pollen Grains, c.s
OPTIKA HC Objective

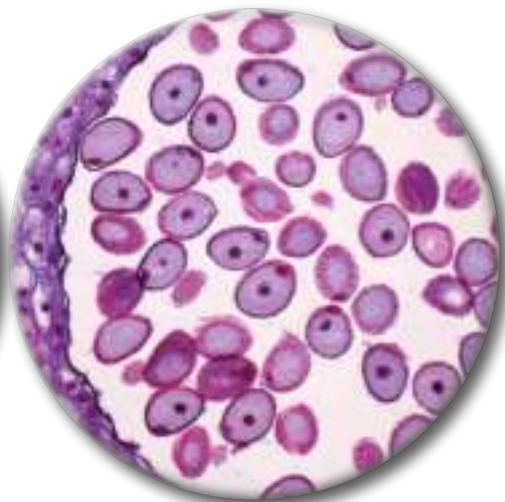

Lily Anther, Mature Pollen Grains, c.s
OPTIKA N-PLAN Objective



HC

N-PLAN

OPTIKA HC: This series of objectives ensures a versatile and reasonably priced entry-level solution for brightfield and simple polarization applications. They are specifically designed to achieve optimal contrast and thus maximize yield on an instrument intended for education on F.N. 18.

OPTIKA N-PLAN: In addition to the advantages of the HC objectives, the total flatness of the field and an even greater contrast are achieved with the N-PLAN series.

B-150 Series - Polarizing Models

B-150P-MRPL



Cordless monocular polarized light microscope ideal for students and primary schools, with three PLAN achromatic lenses (400x), FN 18 high eyepoint eyepiece, finite optical system, coaxial focusing, rotating stage, Abbe condenser and powerful, uniform, white color temperature 1 W **X-LED**¹ illumination. Slim and easy to carry, it is equipped with all the main controls to start learning how to use an advanced microscope and with long lasting LED illumination. Rotating swing-out polarizer and sliding-out fixed analyzer included. The Li-Ion battery (not provided) ensures unparalleled duration and fast recharge.

Head: Monocular, 30° inclined; 360° rotating.

Eyepieces: WF10x/18 mm, high eyepoint, secured by screw.

Nosepiece: Quadruple ball bearings revolving nosepiece.

Objectives:

- N-PLAN plan achromatic 4x/0.10
 - N-PLAN plan achromatic 10x/0.25
 - N-PLAN plan achromatic 40x/0.65.
- All with anti-fungus treatment.

Specimen stage: Rotatable round stage, 120 mm diameter, with sample clips.

Focusing: Coaxial coarse and fine focusing mechanism with limit stop to prevent the contact between objective and specimen. Adjustable tension of coarse focusing knob.

Condenser: N.A. 1.25, pre-centered, fixed, with iris diaphragm.

Illumination: X-LED¹ with white 1 W LED and brightness control. Color temperature: 6,300 K. Li-Ion battery for long lasting operation. Multi-plug 100-240Vac/5Vdc external power supply.

Polarizing filters: Rotating polarizer (swing-out) and fixed analyzer (sliding-out).

B-150P-BRPL



Cordless binocular polarized light microscope ideal for students and primary schools, with three PLAN achromatic lenses (400x), FN 18 high eyepoint eyepieces, finite optical system, coaxial focusing, rotating stage, Abbe condenser and powerful, uniform, white color temperature 1 W **X-LED**¹ illumination. Slim and easy to carry, it is equipped with all the main controls to start learning how to use an advanced microscope and with long lasting LED illumination to provide over 20 years of use. Rotating swing-out polarizer and sliding-out fixed analyzer included. The exclusive Li-Ion battery ensures unparalleled duration and fast recharge

Head: Binocular, 30° inclined; 360° rotating.

Dioptric adjustment: Left eyepiece.

Eyepieces: WF10x/18 mm, high eyepoint, secured by screw.

Nosepiece: Quadruple ball bearings revolving nosepiece.

Objectives:

- N-PLAN plan achromatic 4x/0.10
- N-PLAN plan achromatic 10x/0.25
- N-PLAN plan achromatic 40x/0.65. All with anti-fungus treatment.

Specimen stage: Rotatable round stage, 120 mm diameter, with sample clips.

Focusing: Coaxial coarse and fine focusing mechanism with limit stop to prevent the contact between objective and specimen. Adjustable tension of coarse focusing knob.

Condenser: N.A. 1.25, pre-centered, fixed, with iris diaphragm.

Illumination: X-LED¹ with white 1 W LED and brightness control. Color temperature: 6,300 K. Li-Ion battery for long lasting operation. Multi-plug 100-240Vac/5Vdc external power supply.

Polarizing filters: Rotating polarizer (swing-out) and fixed analyzer (sliding-out).

B-150 Series - Digital Models

B-150D-MRPL

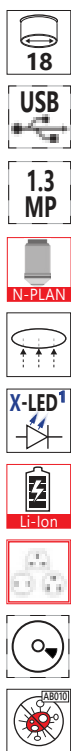

Cordless digital monocular microscope ideal for students and primary schools, with three PLAN achromatic lenses (400x), FN 18 high eyepoint eyepiece, finite optical system, coaxial focusing, mechanical stage, Abbe condenser and powerful, uniform, white color temperature 1 W **X-LED¹** illumination. Slim and easy to carry, it is equipped with all the main controls to start learning how to use an advanced microscope and with long lasting LED illumination to provide over 20 years of use. The exclusive Li-Ion battery ensures unparalleled duration and fast recharge

Head: Monocular with integrated 1.3 MP camera, 30° inclined; 360° rotating.

Eyepieces: WF10x/18 mm, high eyepoint, secured by screw.

Nosepiece: Quadruple ball bearings revolving nosepiece.

Objectives:

- N-PLAN plan achromatic 4x/0.10
- N-PLAN plan achromatic 10x/0.25
- N-PLAN plan achromatic 40x/0.65

Specimen stage: Mechanical stage, 125x116 mm, 70x30 mm X-Y movement range. Vernier scale on the two axes, accuracy: 0.1 mm.

Focusing: Coaxial coarse and fine focusing mechanism with limit stop to prevent the contact between objective and specimen. Adjustable tension of coarse focusing knob.

Condenser: Abbe N.A. 1.25, pre-centered, focusable, with iris diaphragm.

Illumination: X-LED¹ with white 1 W LED and brightness control. Color temperature: 6,300 K. Li-Ion battery for long lasting operation. Multi-plug 100-240Vac/5Vdc external power supply.

B-150D-BRPL

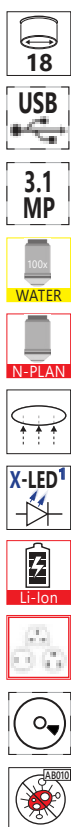

Cordless digital binocular microscope ideal for students and primary schools, with four PLAN achromatic lenses (1000x), FN 18 high eyepoint eyepieces, finite optical system, coaxial focusing, mechanical stage, Abbe condenser and powerful, uniform, white color temperature 1 W **X-LED¹** illumination. Slim and easy to carry, it is equipped with all the main controls to start learning how to use an advanced microscope and with long lasting LED illumination to provide over 20 years of use. The exclusive Li-Ion battery ensures unparalleled duration and fast recharge

Head: Binocular with integrated 3.2 MP camera, 30° inclined; 360° rotating.

Dioptric adjustment: Left eyepiece.

Eyepieces: WF10x/18 mm, high eyepoint, secured by screw.

Nosepiece: Quadruple ball bearings revolving nosepiece.

Objectives:

- N-PLAN plan achromatic 4x/0.10
- N-PLAN plan achromatic 10x/0.25
- N-PLAN plan achromatic 40x/0.65
- N-PLAN plan achromatic 100x/1.25 (oil/water). All with anti-fungal treatment.

Specimen stage: Mechanical stage, 125x116 mm, 70x30 mm X-Y movement range. Vernier scale on the two axes, accuracy: 0.1 mm.

Focusing: Coaxial coarse and fine focusing mechanism with limit stop to prevent the contact between objective and specimen. Adjustable tension of coarse focusing knob.

Condenser: Abbe N.A. 1.25, pre-centered, focusable, with iris diaphragm.

Illumination: X-LED¹ with white 1 W LED and brightness control. Color temperature: 6,300 K. Li-Ion battery for long lasting operation. Multi-plug 100-240Vac/5Vdc external power supply.

B-150 Series - B-150D Camera specifications

	B-150D-MRPL	B-150D-BRPL
Resolution	1280x1024 pixels (1.3 MP)	2048x1536 pixels (3.14 MP)
Sensor	1/3.2" CMOS	1/2.5" CMOS
Pixel size	2.8x2.8 μm	2.2x2.2 μm
Resolution & Frame Rate	1280x1024 - 15 fps	2048x1536 - 4 fps
	640x480 - 30 fps	1280x1024 - 8 fps
		640x480 - 30 fps
Sensitivity	1.0 V/Lux-sec	0.53 V/Lux-sec
White Balance	Auto / Manual	Auto / Manual
S/N Ratio	≥ 40 dB	≥ 40 dB
Dynamic Range	≥ 66.5 dB	≥ 66.5 dB
Digital Port	USB 2.0	USB 2.0
Imaging Software	OPTIKA Vision Lite	OPTIKA Vision Lite
System Requirements	Operating system: Windows XP, Vista, Win7, Win8, Win10, 32-64 bit	

B-150 Series - Optical performance

Eyepiece		10x (M-002.1)			16x (M-003)	
Field number (mm)		18			12	
Objective	N.A.	W.D. (mm)	Total magnification	Field of View (mm)	Total magnification	Field of View (mm)
4x	0.1	18	40x	4.5	64x	3
10x	0.25	7	100x	1.8	160x	1.2
20x	0.4	2	200x	0.9	320x	0.6
40x	0.65	0.53	400x	0.45	640x	0.3
60x	0.8	0.45	600x	0.3	960x	0.2
100x	1.25 (oil/water)	0.13	1000x	0.18	1600x	0.12

B-150 Series - Zoom comparison



Monocot and dicot - B-157 - 4x objective

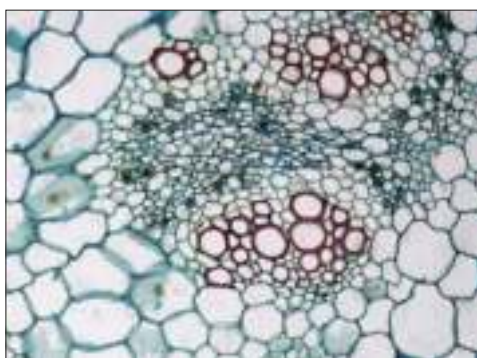

Monocot and dicot - B-157 - 10x objective

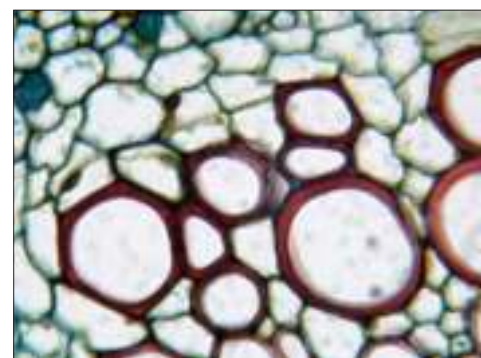

Monocot and dicot - B-157 - 40x objective

B-150 Series - Digital Video Bundles



Five models of the B-150 series can be equipped with a camera and a 7" LCD screen, both in high definition. In these bundles, the normal head (supplied with the instrument) can be replaced with the digital system in a few minutes. This solution provides a system suitable for viewing specimens by several students at the same time, without removing the possibility of using the microscope in the classical way through the eyepiece.

LCD screen: High definition 7" LCD.

Camera: 1920x1080 pixels, 30fps (video). Up to 1844x1080 pixels (photo).

Storing capacity: On Micro Sd card

Video recording: Yes

Measuring function: Yes, simple line measurement

Models available:

-B-151V: Same features than standard B-151, but delivered as bundle together with the 7" screen with built in camera. **Optical head with eyepiece included.**

-B-153V: Same features than standard B-153, but delivered as bundle together with the 7" screen with built in camera. **Optical head with eyepiece included.**

-B-151R-PLV: Same features than standard B-151R-PL, but delivered as bundle together with the 7" screen with built in camera. **Optical head with eyepiece included.**

-B-152R-PLV: Same features than standard B-152R-PL, but delivered as bundle together with the 7" screen with built in camera. **Optical head with eyepiece included.**

-B-159R-PLV: Same features than standard B-159R-PL, but delivered as bundle together with the 7" screen with built in camera. **Optical head with eyepiece included.**

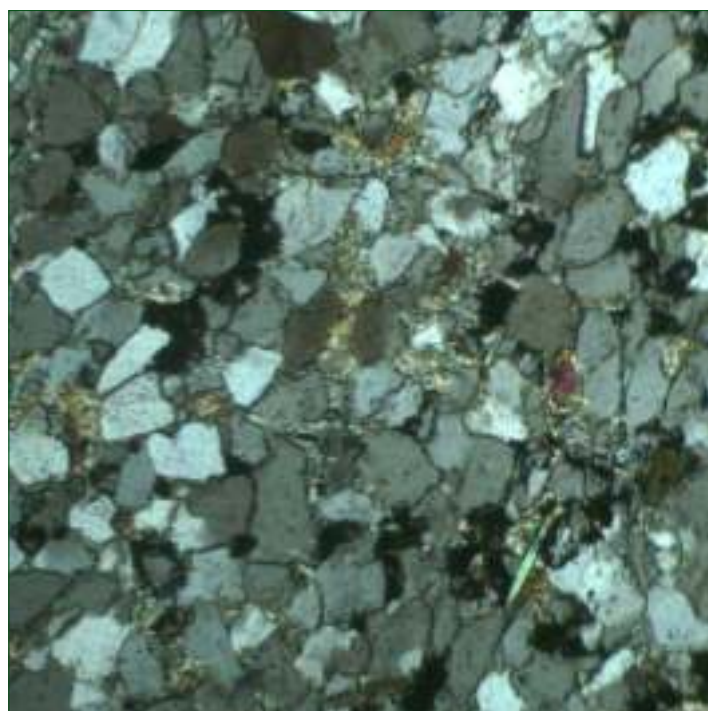

Polarized light observation of quartzite with B-150P-MRPL and 10x objective.

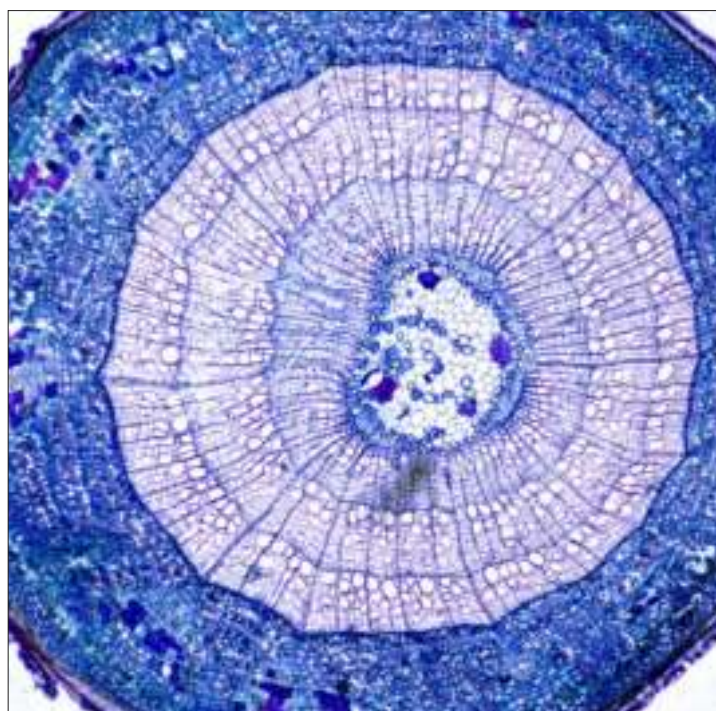

Brightfield observation of tilia three-year stem with B-159 and 20x objective.

B-150 Series - Comparison charts

B-150 - Standard Models, with HC Objectives

Model	Head	Eyepiece(s)	Nosepiece	Objectives	Stage	Focusing	Condenser	Illumination
B-151	Monocular, 30° inclined, 360° rotating	WF 10x/18	Quadruple	HC (high contrast) 4x, 10x, 40x	Fixed, 130x120 mm, with sample clips	Coaxial coarse and fine, limit stop	N.A. 0.65, iris diaphragm, fixed	1 W X-LED ¹ , manual brightness control
B-152 B-153*	Monocular, 30° inclined, 360° rotating	WF 10x/18	Quadruple	HC (high contrast) 4x, 10x, 40x, 60x*	Double layer, 125x116 mm, moving range 70x30 mm	Coaxial coarse and fine, limit stop	Abbe N.A. 1.25, iris diaphragm, focusable	1 W X-LED ¹ , manual brightness control
B-155	Monocular, 30° inclined, 360° rotating	WF 10x/18	Quadruple	HC (high contrast) 4x, 10x, 40x, 100x	Double layer, 125x116 mm, moving range 70x30 mm	Coaxial coarse and fine, limit stop	Abbe N.A. 1.25, iris diaphragm, focusable	1 W X-LED ¹ , manual brightness control
B-156 B-157*	Binocular, 30° inclined, 360° rotating	WF 10x/18	Quadruple	HC (high contrast) 4x, 10x, 40x, 60x*	Double layer, 125x116 mm, moving range 70x30 mm	Coaxial coarse and fine, limit stop	Abbe N.A. 1.25, iris diaphragm, focusable	1 W X-LED ¹ , manual brightness control
B-159	Binocular, 30° inclined, 360° rotating	WF 10x/18	Quadruple	HC (high contrast) 4x, 10x, 40x, 100x	Double layer, 125x116 mm, moving range 70x30 mm	Coaxial coarse and fine, limit stop	Abbe N.A. 1.25, iris diaphragm, focusable	1 W X-LED ¹ , manual brightness control

B-150 - ALC Models, with Automatic Light Control and HC Objectives

Model	Head	Eyepiece(s)	Nosepiece	Objectives	Stage	Focusing	Condenser	Illumination
B-151ALC	Monocular, 30° inclined	WF 10x/18	Quadruple	HC (high contrast) 4x, 10x, 40x	Fixed, 130x120 mm, with sample clips	Coaxial coarse and fine, limit stop	N.A. 0.65 fixed, with diaphragm	1 W X-LED ¹ , manual and automatic brightness control
B-152ALC B-153ALC*	Monocular, 30° inclined	WF 10x/18	Quadruple	HC (high contrast) 4x, 10x, 40x, 60x*	Double layer, 125x116 mm, moving range 70x30 mm	Coaxial coarse and fine, limit stop	Abbe N.A. 1.25, iris diaphragm, focusable	1 W X-LED ¹ , manual and automatic brightness control
B-155ALC	Monocular, 30° inclined	WF 10x/18	Quadruple	HC (high contrast) 4x, 10x, 40x, 100x	Double layer, 125x116 mm, moving range 70x30 mm	Coaxial coarse and fine, limit stop	Abbe N.A. 1.25, iris diaphragm, focusable	1 W X-LED ¹ , manual and automatic brightness control
B-156ALC B-157ALC*	Binocular, 30° inclined	WF 10x/18	Quadruple	HC (high contrast) 4x, 10x, 40x, 60x*	Double layer, 125x116 mm, moving range 70x30 mm	Coaxial coarse and fine, limit stop	Abbe N.A. 1.25, iris diaphragm, focusable	1 W X-LED ¹ , manual and automatic brightness control
B-159ALC	Binocular, 30° inclined	WF 10x/18	Quadruple	HC (high contrast) 4x, 10x, 40x, 100x	Double layer, 125x116 mm, moving range 70x30 mm	Coaxial coarse and fine, limit stop	Abbe N.A. 1.25, iris diaphragm, focusable	1 W X-LED ¹ , manual and automatic brightness control

B-150 - Cordless Models, with N-PLAN Objectives and Li-Ion Rechargeable Batteries

Model	Head	Eyepiece(s)	Nosepiece	Objectives	Stage	Focusing	Condenser	Illumination
B-151R-PL	Monocular, 30° inclined, 360° rotating	WF 10x/18	Quadruple	N-PLAN 4x, 10x, 40x	Fixed, 130x120 mm, with sample clips	Coaxial coarse and fine, limit stop	N.A. 0.65 fixed, with diaphragm	1 W X-LED ¹ , manual brightness control, Li-Ion rechargeable battery
B-152R-PL	Monocular, 30° inclined, 360° rotating	WF 10x/18	Quadruple	N-PLAN 4x, 10x, 40x	Double layer, 125x116 mm, moving range 70x30 mm	Coaxial coarse and fine, limit stop	Abbe N.A. 1.25, iris diaphragm, focusable	1 W X-LED ¹ , manual brightness control, Li-Ion rechargeable battery
B-153R-PL	Monocular, 30° inclined, 360° rotating	WF 10x/18	Quadruple	N-PLAN 4x, 10x, 40x, 60x	Double layer, 125x116 mm, moving range 70x30 mm	Coaxial coarse and fine, limit stop	Abbe N.A. 1.25, iris diaphragm, focusable	1 W X-LED ¹ , manual brightness control, Li-Ion rechargeable battery
B-155R-PL	Monocular, 30° inclined, 360° rotating	WF 10x/18	Quadruple	N-PLAN 4x, 10x, 40x, 100x	Double layer, 125x116 mm, moving range 70x30 mm	Coaxial coarse and fine, limit stop	Abbe N.A. 1.25, iris diaphragm, focusable	1 W X-LED ¹ , manual brightness control, Li-Ion rechargeable battery
B-156R-PL B-157R-PL*	Binocular, 30° inclined, 360° rotating	WF 10x/18	Quadruple	N-PLAN 4x, 10x, 40x, 60x*	Double layer, 125x116 mm, moving range 70x30 mm	Coaxial coarse and fine, limit stop	Abbe N.A. 1.25, iris diaphragm, focusable	1 W X-LED ¹ , manual brightness control, Li-Ion rechargeable battery
B-159R-PL	Binocular, 30° inclined, 360° rotating	WF 10x/18	Quadruple	N-PLAN 4x, 10x, 40x, 100x	Double layer, 125x116 mm, moving range 70x30 mm	Coaxial coarse and fine, limit stop	Abbe N.A. 1.25, iris diaphragm, focusable	1 W X-LED ¹ , manual brightness control, Li-Ion rechargeable battery

B-150 - Polarized Light Cordless Models, with N-PLAN Objectives and Li-Ion Rechargeable Batteries

Model	Head	Eyepiece(s)	Nosepiece	Objectives	Stage	Focusing	Condenser	Illumination
B-150P-MRPL	Monocular, 30° inclined, 360° rotating	WF 10x/18	Quadruple	N-PLAN 4x, 10x, 40x	Round, 360° rotating, 120 mm diameter, with sample clips	Coaxial coarse and fine, limit stop	N.A. 1.25, iris diaphragm, fixed	1 W X-LED ¹ , manual brightness control, Li-Ion rechargeable battery
B-150P-BRPL	Binocular, 30° inclined, 360° rotating	WF 10x/18	Quadruple	N-PLAN 4x, 10x, 40x	Round, 360° rotating, 120 mm diameter, with sample clips	Coaxial coarse and fine, limit stop	N.A. 1.25, iris diaphragm, fixed	1 W X-LED ¹ , manual brightness control, Li-Ion rechargeable battery

B-150 - Digital Cordless Models, with N-PLAN Objectives and Li-Ion Rechargeable Batteries

Model	Head	Eyepiece(s)	Nosepiece	Objectives	Stage	Focusing	Condenser	Illumination
B-150D-MRPL	Monocular, 30° inclined, 360° rotating	WF 10x/18	Quadruple	N-PLAN 4x, 10x, 40x	Double layer, 125x116 mm, moving range 70x30 mm	Coaxial coarse and fine, limit stop	Abbe N.A. 1.25, iris diaphragm, focusable	1 W X-LED ¹ , manual brightness control, Li-Ion rechargeable battery
B-150D-BRPL	Binocular, 30° inclined, 360° rotating	WF 10x/18	Quadruple	N-PLAN 4x, 10x, 40x, 100x	Double layer, 125x116 mm, moving range 70x30 mm	Coaxial coarse and fine, limit stop	Abbe N.A. 1.25, iris diaphragm, focusable	1 W X-LED ¹ , manual brightness control, Li-Ion rechargeable battery

B-150 Series - Accessories

1

Educational

Eyecups & Eyepieces

- M-001 Huygens 5x eyepiece
- M-002.1 WF10x/18 eyepiece, high eyepoint
- M-004 WF10x/18 micrometric eyepiece, high eyepoint
- M-008 WF10x/18 eyepiece, high eyepoint, with pointer
- M-003 WF16x/12 eyepiece
- M-162 WF20x/10 eyepiece

Objectives

HC

- M-137 HC (high contrast) objective 4x/0.10
- M-138 HC (high contrast) objective 10x/0.25
- M-139 HC (high contrast) objective 20x/0.40
- M-141 HC (high contrast) objective 40x/0.65
- M-142 HC (high contrast) objective 60x/0.85
- M-143 HC (high contrast) objective 100x/1.25 (oil)

N-PLAN

- M-164 N-PLAN objective 4x/0.10
- M-165 N-PLAN objective 10x/0.25
- M-166 N-PLAN objective 20x/0.40
- M-167 N-PLAN objective 40x/0.65
- M-168 N-PLAN objective 60x/0.85
- M-169 N-PLAN objective 100x/1.25 (oil)

Stages

- M-040 Attachable mechanical stage (only for B-151, B-151ALC and B-151R-PL)

Condensers & Filters

- M-974 Blue filter, 32mm diameter
- M-976 Green filter, 32mm diameter
- M-978 Yellow filter, 32mm diameter
- M-988 Frosted glass filter, 32mm diameter
- M-155 Polarising set (filters only)

Camera Adapters

- M-115 0.35x C-Mount projection lens
- M-114 0.5x C-Mount projection lens
- M-118 0.75x C-Mount projection lens

Miscellaneous

- 15104 Cleaning kit
- 15008 Immersion oil, 10ml
- 15009 Immersion oil, 100ml
- DC-002 Plastic dust cover, medium, 490(l)x490(h) mm
- M-005 Micrometric slide, 26x76mm, with 2 scales (1mm/100 & 10mm/100)
- M-069 Solar charger
- M-972 Plane-concave mirror, with base
- AB-010 Antibacterial surface treatment, only for newly purchased microscope

M-069 - Solar charger

Included battery: rechargeable – Lithium-Poly. Capacity: 2500 mAh.
Output voltage: 5 Vdc. -
Autonomy: over 6 hours at medium intensity (X-LED³).
Charging models: with solar panel (12h),
with external USB power supply (2.5h)
Not compatible with R models.



15104 - Cleaning kit

It cleans glass quickly and effectively,
without leaving residue or odor.
Ideal for precision lens or prism cleaning.



How to connect the cameras to our microscopes.

Please refer to the Adapter reference list on Digital section.

v 7.5 - OPTIKA reserves the right to make corrections, modifications, enhancements, improvements and other changes to its products at any time without notice.

Headquarters and Manufacturing Facilities

OPTIKA® S.r.l. Via Rigla, 30 - 24010 Ponteranica (BG) - ITALY - Tel.: +39 035.571.392 - info@optikamicroscopes.com

Optika Sales branches

OPTIKA® Spain spain@optikamicroscopes.com
OPTIKA® China china@optikamicroscopes.com
OPTIKA® India india@optikamicroscopes.com

OPTIKA® North America namerica@optikamicroscopes.com
OPTIKA® Central America camerica@optikamicroscopes.com
OPTIKA® Africa africa@optikamicroscopes.com

OPTIKA[®]
M I C R O S C O P E S
I T A L Y

B-190 Series



Advanced Biological Microscopes For Students

Fulfill the Next Generation Learning Challenges

DEPENDABLE TEACHING IN A MODERN AND ERGONOMIC DESIGN

- » Designed for secondary schools and educational labs
- » 18 mm field number for a wide observation area
- » High eyepoint eyepieces for glasses wearers
- » Sturdy and durable for extended lifetime; compact and intuitive
- » External power supply for enhanced safety and convenient servicing



WINDOWS TABLET PC - ONLY AVAILABLE AT OPTIKA

- » A completely new, revolutionary experience for unparalleled comfort
- » Responsive and smooth control for accurate results in few clicks
- » Large touch screen with 360° rotating and tilting holding solution
- » Simultaneous camera and power connection for long-term operation
- » Easily detachable to be used as a laptop (keyboard sold separately)



Inventors Of A New Way To Teach Microscopy

100X OIL/WATER OBJECTIVE - ONLY AVAILABLE AT OPTIKA

- » Same objective for oil and water use
- » Oil represents the best media for high numerical aperture
- » Water combines results with convenience for educational purposes
- » Save time - forget about tedious cleaning and maintenance
- » Save money - no additional expenses due to inappropriate cleaning

100x Oil

100x Water

X-LED² FOR 65,000 HOURS OF OPERATION - ONLY AVAILABLE AT OPTIKA

- » State-of-the-art illumination system for incomparable light intensity
- » Exclusive lens & collector design, unmatched uniformity & brightness
- » Excellent color fidelity, constant pure-white color temperature
- » Money & energy saving, cutting electricity bills by 90%
- » More efficient brightness than a 30 W halogen lamp

Halogen

X-LED¹

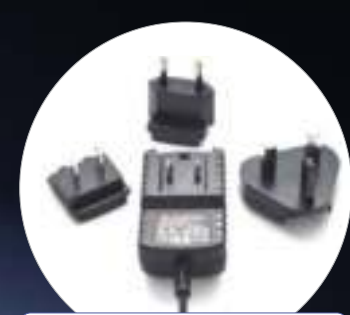

Multi-plug power supply

B-190 Series

Valuable configurations of modern microscopes ideal for teachers and secondary schools, with four achromatic lenses, FN 18 high eyepoint eyepieces, finite optical system, coaxial focusing, mechanical stage and powerful, uniform, white color temperature 3 W X-LED² illumination. Slim and easy to carry, all the models are equipped with long lasting LED illumination to provide over 20 years of use

High eyepoint eyepieces for glasses wearers

These eyepieces are designed in such a way that the exit pupil is further away from the eye lens than standard eyepieces, being are well suited for eyeglasses wearers

X-LED² State-of-the-art illumination system for incomparable light intensity

Provided with an exclusive lens & collector design, OPTIKA X-LED technology ensures unmatched uniformity & brightness (more than a 30 W halogen lamp) for excellent color fidelity with constant pure-white color temperature

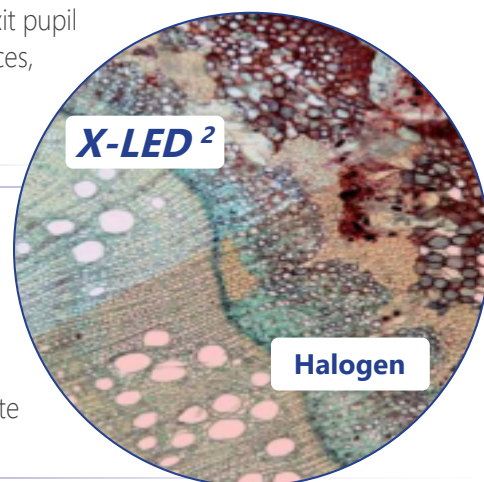

100x oil/water objective: same objective for dual use

This new, revolutionary objective is something you've never seen before! Oil ensures the best performance achievable; water represents the most convenient solution as eliminates tedious cleaning

A completely new, revolutionary experience for unparalleled comfort

B-190TBPL includes built-in camera and Windows tablet PC with large touch screen for a smooth and responsive control, with dependable results in few clicks, and providing an extremely comfortable solution for open discussions

External power supply for enhanced safety and convenient servicing

OPTIKA's safety first approach drives to the use of a low voltage, multi-plug, external power supply in order to prevent any risk of electric shock and heatflow inside the unit



Advanced Biological Microscopes For Students And Teachers

Optimum And Unparalleled Comfort In Use

The B-190TBPL offers you a unique, incomparable solution. It includes a built-in camera of 3.1 MP and a Windows tablet with large touch screen, for a responsive and smooth control. Simultaneous camera and power connection ensure long-term operation, with dependable results in one click. It provides a reliable and comfortable solution for open discussion: 360° rotating and tilting tablet, easily detachable, that can be used as a laptop.

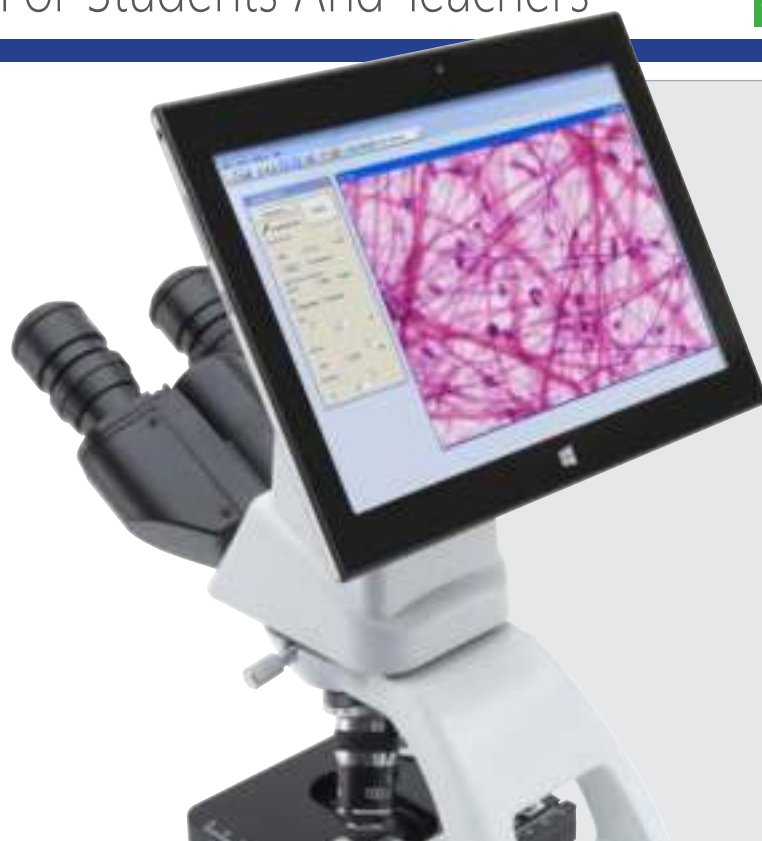

Get the most out of our accessories

ANALYZER

M-174 - Polarizing set

Set for simple polarization analysis. Upgrade your B-190 to a polarizing microscope and look at birefringent samples.



POLARIZER



B-191sPL



Monocular microscope ideal for teachers and secondary schools, with four N-PLAN objectives (600x), FN 18 high eyepoint, finite optical system, coaxial focusing, mechanical stage, Abbe condenser and powerful, uniform, white color temperature 3 W **X-LED²** illumination. Slim and easy to carry, yet sturdy and resistant, it is equipped with all the main controls to start learning how to use an advanced microscope and with long lasting LED illumination to provide over 20 years of use

Head: Monocular, 30° inclined; 360° rotating.

Eyepiece: WF10x/18 mm, high eyepoint, secured by screw.

Nosepiece: Quadruple ball bearings revolving nosepiece, reversed.

Objectives:

- N-PLAN objective 4x/0.10
 - N-PLAN objective 10x/0.25
 - N-PLAN objective 40x/0.65
 - N-PLAN objective 60x/0.85
- All with anti-fungus treatment.

Specimen stage: Mechanical stage, 125x115 mm, 70x30 mm X-Y movement range. Vernier scale on the two axes, accuracy: 0.1 mm.

Focusing: Coaxial coarse and fine focusing mechanism with limit stop to prevent the contact between objective and specimen. Adjustable tension of coarse focusing knob.

Condenser: Abbe N.A. 1.25, pre-centered, focusable, with iris diaphragm.

Illumination: X-LED² with white 3 W LED and brightness control. Color temperature: 6,300 K. Multi-plug 100-240Vac/6Vdc external power supply.

B-191PL



Monocular microscope ideal for teachers and secondary schools, with four N-PLAN objectives (1000x), FN 18 high eyepoint, finite optical system, coaxial focusing, mechanical stage, Abbe condenser and powerful, uniform, white color temperature 3 W **X-LED²** illumination. Slim and easy to carry, yet sturdy and resistant, it is equipped with all the main controls to start learning how to use an advanced microscope and with long lasting LED illumination to provide over 20 years of use

Head: Monocular, 30° inclined; 360° rotating.

Eyepiece: WF10x/18 mm, high eyepoint, secured by screw.

Nosepiece: Quadruple ball bearings revolving nosepiece, reversed.

Objectives:

- N-PLAN objective 4x/0.10
 - N-PLAN objective 10x/0.25
 - N-PLAN objective 40x/0.65
 - N-PLAN objective 100x/1.25 (Oil/Water)
- All with anti-fungus treatment.

Specimen stage: Mechanical stage, 125x115 mm, 70x30 mm X-Y movement range. Vernier scale on the two axes, accuracy: 0.1 mm.

Focusing: Coaxial coarse and fine focusing mechanism with limit stop to prevent the contact between objective and specimen. Adjustable tension of coarse focusing knob.

Condenser: Abbe N.A. 1.25, pre-centered, focusable, with iris diaphragm.

Illumination: X-LED² with white 3 W LED and brightness control. Color temperature: 6,300 K. Multi-plug 100-240Vac/6Vdc external power supply.

B-190 Series - Range

1

Educational

B-192sPL

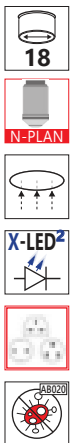

Binocular microscope ideal for teachers and secondary schools, with four N-PLAN objectives (600x), FN 18 high eyepoint, finite optical system, coaxial focusing, mechanical stage, Abbe condenser and powerful, uniform, white color temperature 3 W **X-LED²** illumination. Slim and easy to carry, yet sturdy and resistant, it is equipped with all the main controls to start learning how to use an advanced microscope and with long lasting LED illumination to provide over 20 years of use

Head: Binocular, 30° inclined; 360° rotating.

Dioptric adjustment: Left eyepiece.

Eyepieces: WF10x/18 mm, high eyepoint, secured by screw.

Nosepiece: Quadruple ball bearings revolving nosepiece, reversed.

Objectives:

- N-PLAN objective 4x/0.10
 - N-PLAN objective 10x/0.25
 - N-PLAN objective 40x/0.65
 - N-PLAN objective 60x/0.85
- All with anti-fungus treatment.

Specimen stage: Mechanical stage, 125x115 mm, 70x30 mm X-Y movement range. Vernier scale on the two axes, accuracy: 0.1 mm.

Focusing: Coaxial coarse and fine focusing mechanism with limit stop to prevent the contact between objective and specimen. Adjustable tension of coarse focusing knob.

Condenser: Abbe N.A. 1.25, pre-centered, focusable, with iris diaphragm.

Illumination: X-LED² with white 3 W LED and brightness control. Color temperature: 6,300 K. Multi-plug 100-240Vac/6Vdc external power supply.

B-192PL

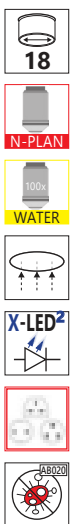

Binocular microscope ideal for teachers and secondary schools, with four N-PLAN objectives (1000x), FN 18 high eyepoint, finite optical system, coaxial focusing, mechanical stage, Abbe condenser and powerful, uniform, white color temperature 3 W **X-LED²** illumination. Slim and easy to carry, yet sturdy and resistant, it is equipped with all the main controls to start learning how to use an advanced microscope and with long lasting LED illumination to provide over 20 years of use

Head: Binocular, 30° inclined; 360° rotating.

Dioptric adjustment: Left eyepiece.

Eyepieces: WF10x/18 mm, high eyepoint, secured by screw.

Nosepiece: Quadruple ball bearings revolving nosepiece, reversed.

Objectives:

- N-PLAN objective 4x/0.10
 - N-PLAN objective 10x/0.25
 - N-PLAN objective 40x/0.65
 - N-PLAN objective 100x/1.25 (Oil/Water)
- All with anti-fungus treatment.

Specimen stage: Mechanical stage, 125x115 mm, 70x30 mm X-Y movement range. Vernier scale on the two axes, accuracy: 0.1 mm.

Focusing: Coaxial coarse and fine focusing mechanism with limit stop to prevent the contact between objective and specimen. Adjustable tension of coarse focusing knob.

Condenser: Abbe N.A. 1.25, pre-centered, focusable, with iris diaphragm.

Illumination: X-LED² with white 3 W LED and brightness control. Color temperature: 6,300 K. Multi-plug 100-240Vac/6Vdc external power supply.

B-190 Series - Range

B-193PL



Trinocular microscope for camera connection ideal for teachers and secondary schools, with four N-PLAN objectives (1000x), FN 18 high eyepoint, finite optical system, coaxial focusing, mechanical stage, Abbe condenser and powerful, uniform, white color temperature 3 W **X-LED²** illumination. Slim and easy to carry, yet sturdy and resistant, it is equipped with all the main controls to start learning how to use an advanced microscope and with long lasting LED illumination to provide over 20 years of use

Head: Trinocular (split ratio: 50/50), 30° inclined; 360° rotating.

Dioptric adjustment: Left eyepiece.

Eyepieces: WF10x/18 mm, high eyepoint, secured by screw.

Nosepiece: Quadruple ball bearings revolving nosepiece, reversed.

Objectives:

- N-PLAN objective 4x/0.10
 - N-PLAN objective 10x/0.25
 - N-PLAN objective 40x/0.65
 - N-PLAN objective 100x/1.25 (Oil/Water)
- All with anti-fungus treatment.

Specimen stage: Mechanical stage, 125x115 mm, 70x30 mm X-Y movement range. Vernier scale on the two axes, accuracy: 0.1 mm.

Focusing: Coaxial coarse and fine focusing mechanism with limit stop to prevent the contact between objective and specimen. Adjustable tension of coarse focusing knob.

Condenser: Abbe N.A. 1.25, pre-centered, focusable, with iris diaphragm.

Illumination: X-LED² with white 3 W LED and brightness control. Color temperature: 6,300 K. Multi-plug 100-240Vac/6Vdc external power supply.

B-190TBPL



Digital binocular microscope ideal for teachers and secondary schools, with four N-PLAN objectives (1000x), FN 18 high eyepoint, finite optical system, coaxial focusing, mechanical stage, Abbe condenser and powerful, uniform, white color temperature 3 W **X-LED²** illumination. The 3.1 MP CMOS camera ensures excellent colour reproduction and is connected to a Windows tablet PC with vivid color graphic display for unparalleled comfort and performance. The tablet represents a 2-in-1 solution as it can be disconnected and used as a real PC, being Windows-based, with powerful Intel processor and large touch screen of 10.1" for fast, responsive and smooth control

Head: Binocular with integrated 3.1 MP camera, 30° inclined; 360° rotating. Detachable Windows tablet PC included, rotating and tilting.

Dioptric adjustment: Left eyepiece.

Eyepieces: WF10x/18 mm, high eyepoint, secured by screw.

Nosepiece: Quadruple ball bearings revolving nosepiece, reversed.

Objectives:

- N-PLAN objective 4x/0.10
- N-PLAN objective 10x/0.25
- N-PLAN objective 40x/0.65
- N-PLAN objective 100x/1.25 (Oil/Water). All with anti-fungus treatment.

Specimen stage: Mechanical stage, 125x115 mm, 70x30 mm X-Y movement range. Vernier scale on the two axes, accuracy: 0.1 mm.

Focusing: Coaxial coarse and fine focusing mechanism with limit stop to prevent the contact between objective and specimen. Adjustable tension of coarse focusing knob.

Condenser: Abbe N.A. 1.25, pre-centered, focusable, with iris diaphragm.

Illumination: X-LED² with white 3 W LED and brightness control. Color temperature: 6,300 K. Multi-plug 100-240Vac/6Vdc external power supply

B-190TBPL - Digital Microscope with Camera & Tablet

The latest OPTIKA digital microscopes with Windows tablet PC open new microscopy horizons, combining high-end optics with innovative digital technology for microscopic imaging. B-190TB includes a 3.1 MP camera with a 10.1" Windows tablet. View, capture, analyze and share your images with simplicity and reliability.

Intuitive, Yet Powerful Software

Simple and user-friendly, ideal for students and experienced users.

PATENTED



Unique Features

- > Simultaneous camera & power connection
- > Equipped with the latest **Windows OS & Intel** processor
- > Easily detachable, can be used as a laptop (keyboard sold separately)

360° Rotating & Tilting



Detachable



TB-KBD2 - Accessory keyboard for tablet

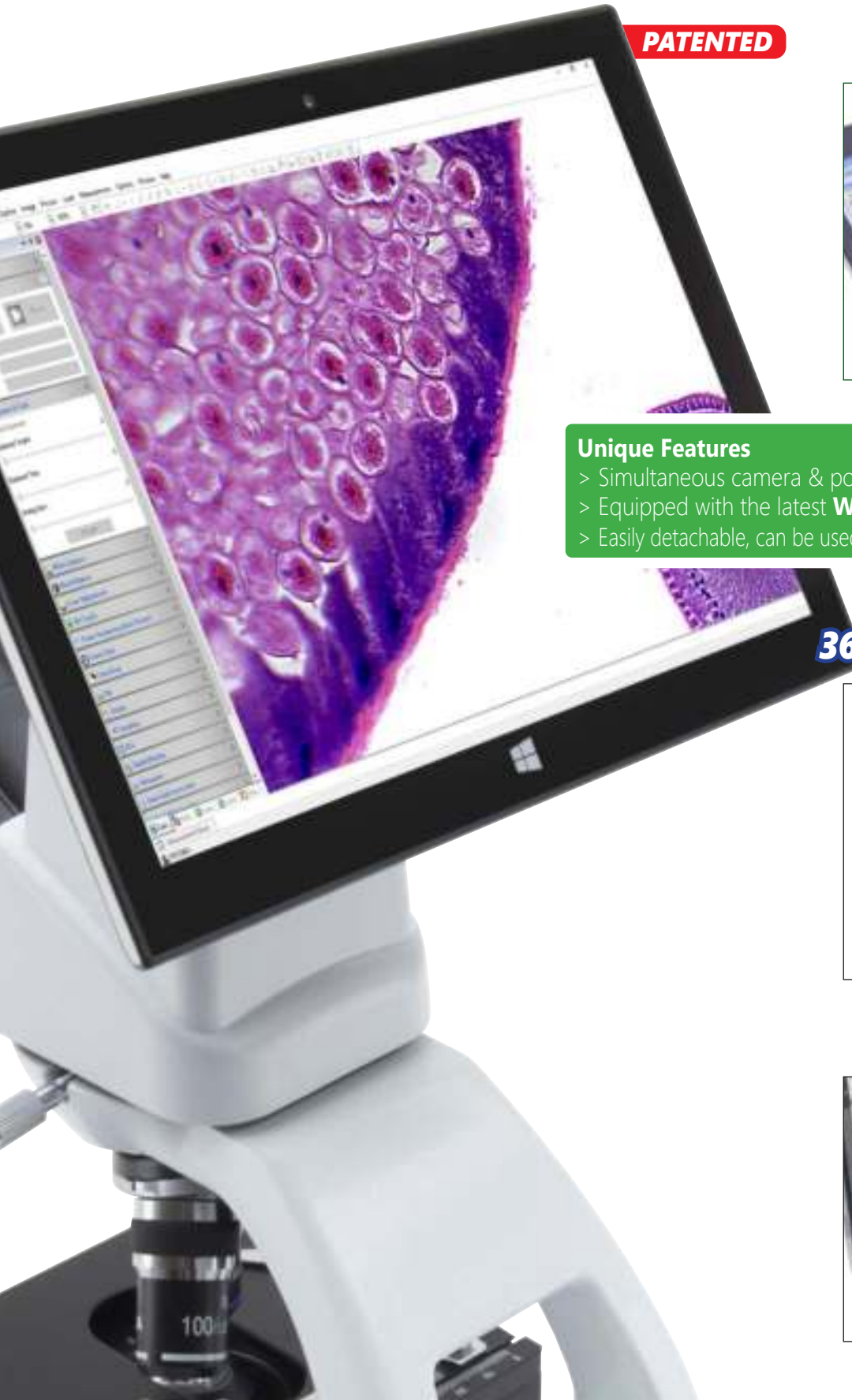

B-190TBPL - Digital microscope with camera & tablet

Tilting



TABLET TECHNICAL SPECIFICATIONS

Operating system	Windows 10 (64Bit)
CPU	Gemini-Lake, N4100
CPU speed	1.10 GHz
Graphic card	Intel® HD Graphics 600
RAM	Ram 6 GB LPDDR3
Display size	LED 10.1" IPS Multi Touch Screen
Display resolution	1920x1200
Storage	Hdd 128 GB
Network	WiFi (2.4G / 5G) - Bluetooth 5.0
Input ports	USB-C (1 USB2.0 for battery charge, 1 USB3.0) - Micro SD card reader
Output ports	Microphone - Headphone - Micro HDMI
Battery Type	Lithium-ion
Battery capacity	6500 mAh
Power consumption	24.05W
Power supply	12V 2A EU
Dimensions (mm)	261 x 167 X 9
Weight (Kg)	0.53
Language	Multilanguage
Weight	530 g
Tablet accessories included	USB cable USB-B to USB-A (0.5m)

CAMERA TECHNICAL SPECIFICATIONS

Digital camera resolution	3.14 MPixel
Signal output	USB 2.0
Sensor Size	1/2.5"
Sensor technology	CMOS
Image format	4\3
Full Image size	2048 x 1536
Pixel size	2.2 x 2.2 micron
Frame rate full resolution	5 frames\sec
Frame rate other resolutions	8 FPS (1280x1024) - 30FPS (640x480)
Automatic White Balance	Auto - Man
Automatic Gain Control	Auto - Man
Automatic Back light control	Auto - Man
Exposure control	Auto - Man

B-190 Series - Optical performance

Eyepiece		10x (M-002.1)			16x (M-003)	
Field number (mm)		18			12	
Objective	N.A.	W.D (mm)	Total magnification	Field of View (mm)	Total magnification	Field of View (mm)
4x	0.1	15.2	40x	4.5	64x	3
10x	0.25	5.5	100x	1.8	160x	1.2
20x	0.4	3.5	200x	0.9	320x	0.6
40x	0.65	0.45	400x	0.45	640x	0.3
60x	0.85	0.45	600x	0.3	960x	0.2
100x	1.25 (oil/water)	0.13	1000x	0.18	1600x	0.12



N-PLAN

OPTIKA N-PLAN objectives ensure bright, clear images with excellent flatness and compensation for chromatic aberration.

B-190 Series - Zoom comparison

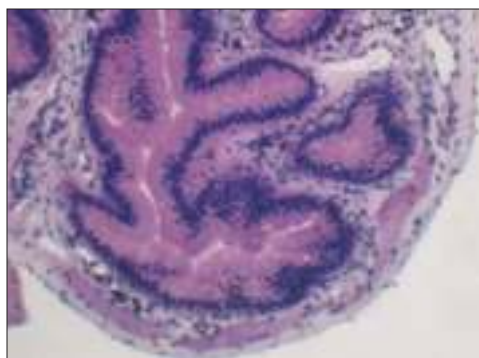

Frog small intestine - B-193PL - 10x objective

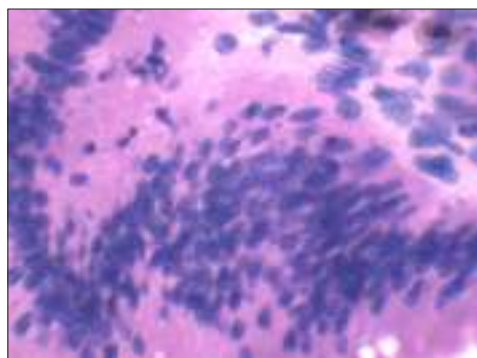

Frog small intestine - B-193PL - 40x objective

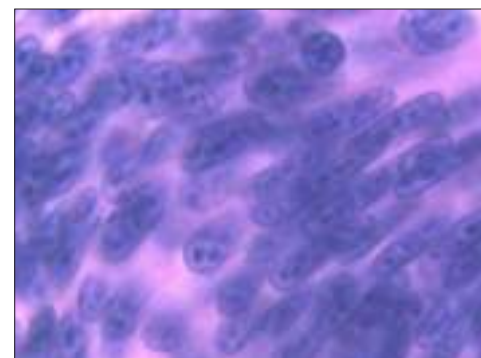

Frog small intestine - B-193PL - 100x Oil objective

B-190 Series - Comparison chart

Model	Head	Eyepiece(s)	Nosepiece	Objectives	Stage	Focusing	Condenser	Illuminator
B-191sPL	Monocular, 360° rotating, 30° inclined	Wide Field 10x/18mm	Quadruple, reversed	N-PLAN 4x, 10x, 40x, 60x	Double layer, 125x115 mm with 70x30mm X-Y moving range	Coaxial coarse and fine focusing	N.A. 1.25 Abbe type with adjustable height and iris diaphragm	3 W X-LED ² , brightness control
B-191PL	Monocular, 360° rotating, 30° inclined	Wide Field 10x/18mm	Quadruple, reversed	N-PLAN 4x, 10x, 40x, 100x	Double layer, 125x115 mm with 70x30mm X-Y moving range	Coaxial coarse and fine focusing	N.A. 1.25 Abbe type with adjustable height and iris diaphragm	3 W X-LED ² , brightness control
B-192sPL	Binocular, 360° rotating, 30° inclined	Wide Field 10x/18mm	Quadruple, reversed	N-PLAN 4x, 10x, 40x, 60x	Double layer, 125x115 mm with 70x30mm X-Y moving range	Coaxial coarse and fine focusing	N.A. 1.25 Abbe type with adjustable height and iris diaphragm	3 W X-LED ² , brightness control
B-192PL	Binocular, 360° rotating, 30° inclined	Wide Field 10x/18mm	Quadruple, reversed	N-PLAN 4x, 10x, 40x, 100x	Double layer, 125x115 mm with 70x30mm X-Y moving range	Coaxial coarse and fine focusing	N.A. 1.25 Abbe type with adjustable height and iris diaphragm	3 W X-LED ² , brightness control
B-193PL	Trinocular, 360° rotating, 30° inclined	Wide Field 10x/18mm	Quadruple, reversed	N-PLAN 4x, 10x, 40x, 100x	Double layer, 125x115 mm with 70x30mm X-Y moving range	Coaxial coarse and fine focusing	N.A. 1.25 Abbe type with adjustable height and iris diaphragm	3 W X-LED ² , brightness control
B-190TBPL	Binocular, digital 360° rotating, 30° inclined	Wide Field 10x/18mm	Quadruple, reversed	N-PLAN 4x, 10x, 40x, 100x	Double layer, 125x115 mm with 70x30mm X-Y moving range	Coaxial coarse and fine focusing	N.A. 1.25 Abbe type with adjustable height and iris diaphragm	3 W X-LED ² , brightness control

B-190 Series - Accessories

Eyecups & Eyepieces

- M-001 Huygens 5x eyepiece
- M-002.1 WF10x/18 eyepiece, high eyepoint
- M-004 WF10x/18 micrometric eyepiece, high eyepoint
- M-008 WF10x/18 eyepiece, high eyepoint, with pointer
- M-003 WF16x/12 eyepiece
- M-162 WF20x/10 eyepiece

Objectives

- M-164 N-PLAN objective 4x/0.10
- M-165 N-PLAN objective 10x/0.25
- M-166 N-PLAN objective 20x/0.40
- M-167 N-PLAN objective 40x/0.65
- M-168 N-PLAN objective 60x/0.85
- M-169 N-PLAN objective 100x/1.25 (oil)

Condensers & Filters

- M-174 Polarising set (filters only)
- M-974 Blue filter, 32 mm diameter
- M-976 Green filter, 32 mm diameter
- M-978 Yellow filter, 32 mm diameter
- M-988 Frosted glass filter, 32 mm diameter

Camera Adapters

- M-115 0.35x C-Mount projection lens
- M-114 0.5x C-Mount projection lens
- M-118 0.75x C-Mount projection lens
- M-173 C-Mount projection lens for APS-C/full frame reflex cameras (trino)

Miscellaneous

- 15104 Cleaning kit
- 15008 Immersion oil, 10ml
- 15009 Immersion oil, 100ml
- DC-002 Plastic dust cover, medium, 490(l)x490(h) mm (except for B-190TB)
- DC-003 TNT dust cover, medium, 600(l)x550(h) mm (only for B-190TB)
- TB-KBD2 Keyboard for tablet (only for B-190TB)
- M-005 Micrometric slide, 26x76mm, with 2 scales (1mm/100 & 10mm/100)
- M-069 Solar charger
- M-971 Plane-concave mirror, with base
- VP-190 IQ/OQ/PQ manual for B-190 series
- VP-TB IQ/OQ/PQ manual for TB series
- AB-020 Antibacterial surface treatment, only for newly purchased microscope

M-069 - Solar charger

Included battery: rechargeable – Lithium-Poly. Capacity: 2500 mAh.
Output voltage: 5 Vdc. -
Autonomy: over 6 hours at medium intensity (X-LED³).
Charging models: with solar panel (12h),
with external USB power supply (2.5h)

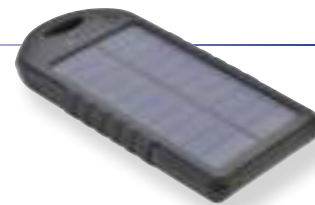

15104 - Cleaning kit

It cleans glass quickly and effectively,
without leaving residue or odor.
Ideal for precision lens or prism cleaning.



How to connect the cameras to our microscopes.

Please refer to the Adapter reference list on Digital section.

v 7.5 - OPTIKA reserves the right to make corrections, modifications, enhancements, improvements and other changes to its products at any time without notice.

Headquarters and Manufacturing Facilities

OPTIKA® S.r.l. Via Rigla, 30 - 24010 Ponteranica (BG) - ITALY - Tel.: +39 035.571.392 - info@optikamicroscopes.com

Optika Sales branches

OPTIKA® Spain spain@optikamicroscopes.com
OPTIKA® China china@optikamicroscopes.com
OPTIKA® India india@optikamicroscopes.com

OPTIKA® North America namerica@optikamicroscopes.com
OPTIKA® Central America camerica@optikamicroscopes.com
OPTIKA® Africa africa@optikamicroscopes.com

OPTIKA[®]
M I C R O S C O P E S
I T A L Y

MS/SFX Series



Entry-Level Monoscopes & Stereomicroscopes For Students

Addressed For Simplicity & The Youngest Users

EDUCATIONAL STEREOMICROSCOPES DESIGNED FOR NOVICE USERS

- » Particularly recommended for primary/secondary schools & amateurs
- » 3D Greenough view for high resolved images & large field depth
- » Turnable objectives, up to 3 magnifications on 20 mm field number
- » Longlife LED illumination (providing over 20 years of use)
- » Sturdy and durable for extended lifetime; compact and intuitive

TOUCH CONTROL, A NEW FRONTIER IN ILLUMINATION ADJUSTMENT

- » Light intensity settable via a simple click
- » Cordless use, totally independent from mains/batteries connection
- » Battery status indicator informs when the battery is ready to be used
- » Freely settable illumination for incident and transmitted light
- » External power supply for enhanced safety and convenient servicing

MS/SFX Series

A great variety of mainly cordless binocular stereomicroscopes with turnable objectives, FN 20 eyepieces, 1 W LED transmitted/incident illumination and different stands to start exploring and discovering sciences and materials, including biology, entomology, rocks, plants, and many more specimens. Most of the models are equipped with premium features, such as the exclusive, comfortable touch control and the rechargeable batteries. Slim and easy to carry, all the models are equipped with long lasting LED illumination to provide over 20 years of use



Turnable objectives, up to 3 magnifications on 20 mm field number

SFX series is designed for basic operations, being provided with widefield eyepieces and objective turret magnification changer (up to 3 magnifications) for step magnification

Touch control - light intensity settable via a simple click

SFX Series represents a new frontier in illumination adjustment with an incredibly comfortable solution: the touch control, consisting in 10 pre-set intensity levels (5 for transmitted, 5 for incident)

Cordless use, totally independent from the mains/batteries connection

SFX Series works with or without the batteries in place and are provided with three NiMH rechargeable batteries for the longest autonomy in outdoor use (4-hour autonomy, at medium intensity)

MS/SFX Series

Battery status indicator informs when batteries are ready to be used

SFX Series has a smart charging indicator which indicates current charging status at all times - even when not in charge or during storage: if it is on, it means it is immediately ready to work

Longlife LED illumination (providing over 20 years of use)

Money & energy saving thanks to LED long lifetime (65.000 hours, 22 years in case of 8 hours/day) which is more than 20 times compared to a standard halogen bulb

External power supply for enhanced safety and convenient servicing

OPTIKA's safety first approach drives to the use of a low voltage, multi-plug, external power supply in order to prevent any risk of electric shock and heatflow inside the unit



ST-50Led - When Long Working Distance Is Required

ST-50Led has a special objective with long working distance that allows you to inspect bulky samples, thanks also to its overhanging arm stand and LED flexible incident light

MS-01 - Multifunctional Testing Equipment

MS-01 is a portable monoscope ideal as versatile testing equipment especially for surface analysis and measurements to be used directly on the specimen with 10x objective and penlight for incident illumination

GREENOUGH



MS/SFX Series - Range

MS-1

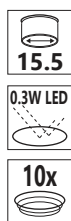

Portable monoscope ideal as multifunctional testing equipment especially for surface analysis and measurements to be used directly on the specimen. Equipped with fixed objective (10x), FN 15.5 eyepiece with crosshair and 0.3 W LED penlight for incident illumination powered by rechargeable batteries

Eyepiece: WF10x/15.5 mm, micrometric with crosshair.

Objective: Achromatic 10x with anti-fungus treatment.

Working distance: 6 mm.

Focusing: Rack and pinion focusing mechanism.

Illumination: 0.3 W LED incident penlight with batteries (not included).

SFX-31



Cordless binocular stereomicroscope ideal for students, schools and amateurs to dissect and discover mainly biology and materials science in 3D, with turnable objective (2x-4x), FN 20 eyepieces, pillar stand and 1 W LED transmitted / incident illumination with rechargeable batteries. Slim and easy to carry, it is equipped with long lasting LED illumination to provide over 20 years of use

Head: Binocular, 45° inclined.

Dioptric adjustment: Both eyepieces.

Eyepieces: WF10x/20 mm, secured by screw and with rubber cups.

Objective: Achromatic 2x-4x with anti-fungus treatment.

Working distance: 57 mm.

Stand: Pillar with focus.

Focusing: Rack and pinion focusing mechanism.

Illumination: 1 W LED incident and transmitted, with brightness control, rechargeable batteries. Color temperature: 6,300 K. Multi-plug 100-240Vac/5Vdc external power supply.

MS/SFX Series - Range

1

Educational

SFX-33

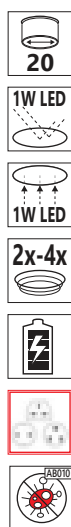

Cordless binocular stereomicroscope ideal for students, schools and amateurs to dissect and discover mainly biology and materials science in 3D, with turnable objective (2x-4x), FN 20 eyepieces, fixed arm with handle and 1 W LED transmitted / incident illumination with comfortable touch control and rechargeable batteries. Slim and easy to carry, it is equipped with long lasting LED illumination to provide over 20 years of use

Head: Binocular, 45° inclined.

Dioptric adjustment: Both eyepieces.

Eyepieces: WF10x/20 mm, secured by screw and with rubber cups.

Objective: Achromatic 2x-4x with anti-fungus treatment.

Working distance: 57 mm

Stand: Fixed with handle and focus.

Focusing: Rack and pinion focusing mechanism.

Illumination: 1 W LED incident and transmitted, with touch brightness control, rechargeable batteries. Color temperature: 6,300 K. Multi-plug 100-240Vac/5Vdc external power supply.

SFX-51

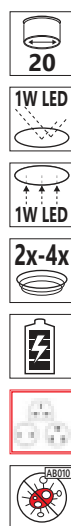

Cordless binocular stereomicroscope ideal for students, schools and amateurs to dissect and discover mainly biology and materials science in 3D, with turnable objective (2x-4x), FN 20 eyepieces, 360° rotating head, fixed arm with handle and 1 W LED transmitted / incident illumination with comfortable touch control and rechargeable batteries. Slim and easy to carry, it is equipped with long lasting LED illumination to provide over 20 years of use

Head: Binocular, 45° inclined; 360° rotating.

Dioptric adjustment: Both eyepieces.

Eyepieces: WF10x/20 mm, secured by screw and with rubber cups.

Objective: Achromatic 2x-4x with anti-fungus treatment.

Working distance: 76 mm







Stand: Fixed with handle and focus.

Focusing: Rack and pinion focusing mechanism.

Illumination: 1 W LED incident and transmitted, with touch brightness control, rechargeable batteries. Color temperature: 6,300 K. Multi-plug 100-240Vac/5Vdc external power supply

MS/SFX Series - Range

SFX-91

-  20
-  1W LED
-  1W LED
-  1x-2x-4x
- 
- 
- 



Cordless binocular stereomicroscope ideal for students, schools and amateurs to dissect and discover mainly biology and materials science in 3D, with turnable objective (1x-2x-4x), FN 20 eyepieces, precision fixed arm with handle and 1 W LED transmitted / incident illumination with comfortable touch control and rechargeable batteries. Slim and easy to carry, it is equipped with long lasting LED illumination to provide over 20 years of use

Head: Binocular, 45° inclined.

Dioptric adjustment: Both eyepieces.

Eyepieces: WF10x/20 mm, secured by screw and with rubber cups.

Objective: Achromatic 1x-2x-4x with anti-fungus treatment.

Working distance: 60 mm.

Stand: High-grade, precision fixed with handle and focus.

Focusing: Rack and pinion focusing mechanism.

Illumination: 1 W LED swiveling incident and transmitted, with touch brightness control, rechargeable batteries. Color temperature: 6,300 K. Multi-plug 100-240Vac/5Vdc external power supply

SFX-91D

-  20
-  1W LED
-  1W LED
-  1x-2x-4x
- 
- 
-  5 MP
- 
- 
- 



Cordless digital binocular stereomicroscope ideal for students, schools and amateurs to dissect and discover mainly biology and materials science in 3D, with turnable objective (1x-2x-4x), FN 20 eyepieces, precision fixed arm with handle and 1 W LED transmitted / incident illumination with comfortable touch control and rechargeable batteries. Slim and easy to carry, it is equipped with long lasting LED illumination to provide over 20 years of use

Head: Binocular with integrated 5 MP camera, 45° inclined.

Dioptric adjustment: Both eyepieces.

Eyepieces: WF10x/20 mm, secured by screw and with rubber cups.

Objective: Achromatic 1x-2x-4x with anti-fungus treatment.

Working distance: 60 mm.

Stand: High-grade, precision fixed with handle and focus.

Focusing: Rack and pinion focusing mechanism.

Illumination: 1 W LED swiveling incident and transmitted, with touch brightness control, rechargeable batteries. Color temperature: 6,300 K. Multi-plug 100-240Vac/5Vdc external power supply.

MS/SFX Series - Range

ST-50Led

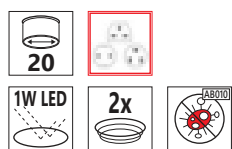

Binocular stereomicroscope ideal for large specimens, with long working distance fixed objective (2x), FN 20 eyepieces, overhanging stand and 1 W LED swiveling incident illumination. Additional objectives available for different magnifications

Head: Binocular, 45° inclined.

Dioptric adjustment: Left eyepiece.

Eyepieces: WF10x/20 mm, secured by screw.

Objective: Achromatic 2x with anti-fungus treatment.

Working distance: 110 mm.

Stand: Overhanging with focus.

Focusing: Rack and pinion focusing mechanism.

Illumination: 1 W LED swiveling incident on flexible arm.

Color temperature: 6,300 K. Multi-plug 100-240Vac/6Vdc external power supply.

MS/SFX Series - Comparison Chart

Model	Head	Eyepieces	Objective	Working Distance	Stand	Illumination
MS-1	-	WF 10x/15.5	10x fixed	6 mm	Fixed with focus	0.3 W LED penlight. Powered by AAA batteries (not included)
SFX-31	Binocular, 45° inclined, fixed	WF 10x/20	2x – 4x selectable	57 mm	Pillar with focus	Incident: 1 W LED Transmitted: 1 W LED Dial brightness control Rechargeable batteries
SFX-33	Binocular, 45° inclined, fixed	WF 10x/20	2x – 4x selectable	57 mm	Fixed with focus and handle	Incident: 1 W LED Transmitted: 1 W LED Touch brightness control Rechargeable batteries
SFX-51	Binocular, 45° inclined, 360° rotating	WF 10x/20	2x – 4x selectable	76 mm	Fixed with focus and handle	Incident: 1 W LED Transmitted: 1 W LED Touch brightness control Rechargeable batteries
SFX-91	Binocular, 45° inclined, fixed	WF 10x/20	1x – 2x – 4x selectable	60 mm	High-grade fixed with focus and handle	Incident: 1 W LED Transmitted: 1 W LED Touch brightness control Rechargeable batteries
SFX-91D	Binocular, 45° inclined, 5 MP integrated camera	WF 10x/20	1x – 2x – 4x selectable	60 mm	High-grade fixed with focus and handle	Incident: 1 W LED Transmitted: 1 W LED Touch brightness control Rechargeable batteries
ST-50Led	Binocular, 45° inclined, fixed	WF 10x/20	2x fixed	119 mm	Overhanging with focus	Incident: 1 W LED on flexible arm

MS/SFX Series - Accessories

ACCESSORIES FOR MS-1

Miscellaneous

DC-001	Plastic dust cover, small, 340(l)x400(h) mm
M-899	Pen illuminator
15104	Cleaning kit

ACCESSORIES FOR SFX SERIES & ST-50Led

Eyecups & Eyepieces

ST-001	WF5x/22 eyepieces (pair), 30.5mm diameter (except for ST-50Led)
ST-002	WF10x/20 eyepieces (pair)
ST-003	WF15x/15 eyepieces (pair)
ST-004	WF20x/13 eyepieces (pair)
ST-005	WF10x/20 micrometric eyepiece
ST-001.1	WF5x/22 eyepieces (pair), 30mm diameter (only for ST-50Led)

Objectives

ST-025	1x objective (only for ST-50Led)
ST-026	3.5x objective (only for ST-50Led)

Stage

ST-014	Glass object-plate, 95mm diameter (only for ST-30FX)
ST-015	Glass object-plate, 60mm diameter (except for ST-30FX & ST-50Led)
ST-011	White/black object-plate, 60mm diameter (except for ST-30FX & ST-50Led)
ST-012	White/black object-plate, 95mm diameter (only for ST-30FX)

Camera Adapters

M-114	0.5x C-Mount projection lens
M-115	0.35x C-Mount projection lens
M-118	0.75x C-Mount projection lens

Miscellaneous

M-113.1	Ring adapter, 30mm (for monocular and binocular microscopes) (except ST-50Led)
M-113.2	Ring adapter, 30.5mm (for monocular and binocular microscopes) (only for ST-50Led)
DC-001	Plastic dust cover, small, 340(l)x400(h) mm (except for ST-50Led)
DC-002	Plastic dust cover, medium, 490(l)x490(h) mm (only for ST-50Led)
M-005	Micrometric slide, 26x76mm, with 2 scales (1mm/100 & 10mm/100)
15104	Cleaning kit
ST-041	Sample clip (only for ST-30FX)
AB-010	Antibacterial surface treatment, only for newly purchased microscope

15104 - Cleaning kit

It cleans glass quickly and effectively, without leaving residue or odor. Ideal for precision lens or prism cleaning.



How to connect the cameras to our microscopes.

Please refer to the Adapter reference list on Digital section.

v 7.5 - OPTIKA reserves the right to make corrections, modifications, enhancements, improvements and other changes to its products at any time without notice.

Headquarters and Manufacturing Facilities

OPTIKA® S.r.l. Via Rigla, 30 - 24010 Ponteranica (BG) - ITALY - Tel.: +39 035.571.392 - info@optikamicroscopes.com

Optika Sales branches

OPTIKA® Spain spain@optikamicroscopes.com
OPTIKA® China china@optikamicroscopes.com
OPTIKA® India india@optikamicroscopes.com

OPTIKA® North America namerica@optikamicroscopes.com
OPTIKA® Central America camerica@optikamicroscopes.com
OPTIKA® Africa africa@optikamicroscopes.com

OPTIKA[®]
M I C R O S C O P E S
I T A L Y

SLX Series



Stereomicroscopes For Higher Education & Laboratory

Extremely Versatile Cordless Stereo & Stereozoom Microscopes

PROFESSIONAL FEATURES FOR... WELL, EVERYONE

- » Level up skills and become a professional user
- » 3D Greenough view for high resolved images & large field depth
- » 6.43:1 ratio - 7x ... 45x - or turnable objective - 2x, 4x - on 21 mm
- » Compact, practical and intuitive to use
- » Sturdy and durable for extended lifetime

THE LONGEST AUTONOMY ON THE MARKET

- » Longlife LED illumination (providing over 20 years of use)
- » Ultra-flat base with Ø 100 mm disc for diffused transmitted light
- » Cordless use, totally independent from mains/batteries connection
- » Freely settable illumination - incident, oblique and transmitted light
- » External power supply for enhanced safety and convenient servicing

SLX Series

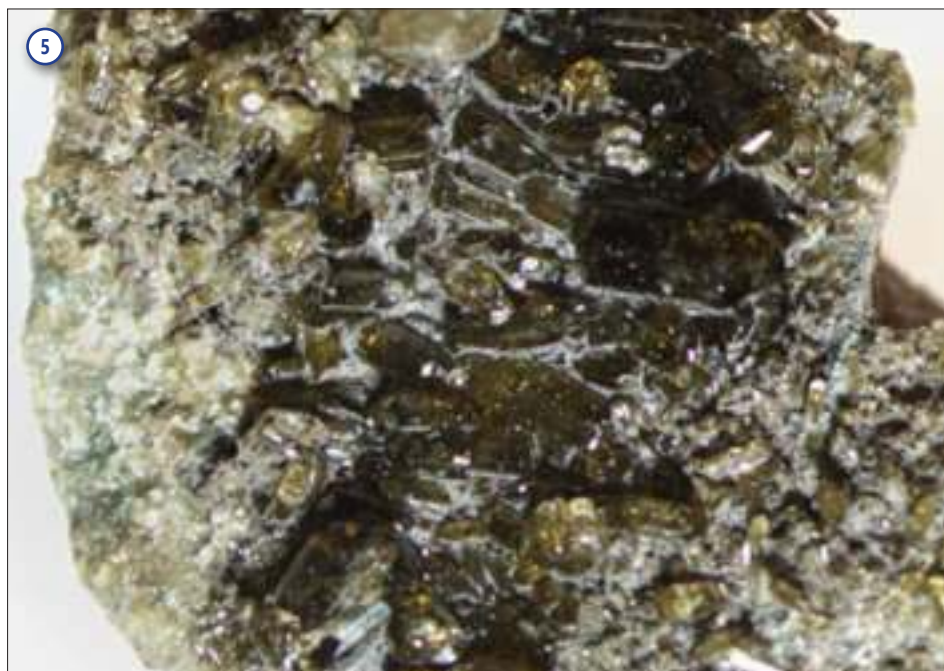
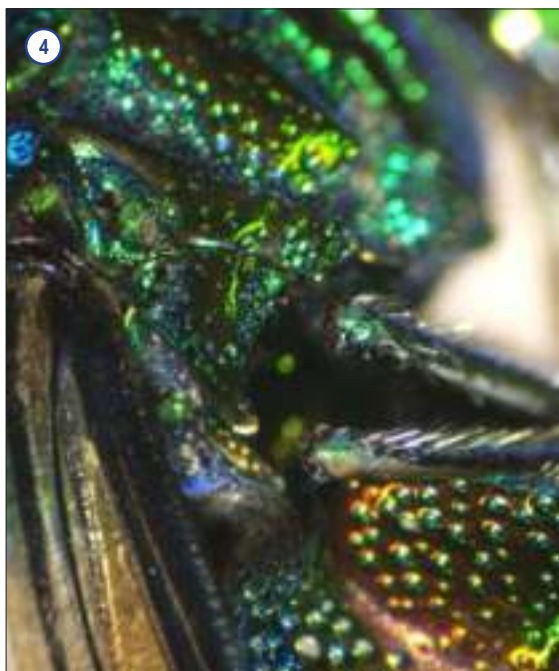

Legend

1. Aluminum - SLX-1 and 4x objective.
2. Component worked on lathe - SLX-2 and 3x zoom.
3. Wasp - SLX-3 and 4x zoom.
4. Fly, detail - SLX-2 and 4.5x zoom.
5. Rock - SLX-2 - 1.5x zoom.

SLX Series



Valuable configurations of cordless and modern stereo & stereozoom microscopes ideal for a variety of applications, including industrial purposes as well as dissection, biology, entomology, anatomy, chemistry and material science among the others.

Provided with dual magnification or **6.43:1 zoom ratio**, **FN 21** high eyepoint eyepieces, high-grade precise fixed arm with focus and handle with the latest technology of **EcoLED™** illumination plus rechargeable batteries. Slim and easy to carry, all the models are equipped with long lasting LED illumination to provide over 20 years of use

High eyepoint eyepieces for glasses wearers

These eyepieces are designed in such a way that the exit pupil is further away from the eye lens than standard eyepieces, being well suited for eyeglasses wearers

The longest autonomy on the market ensured by EcoLED™

OPTIKA has re-designed illumination in microscopy, once again: a special coating process on optics combined with a new, higher ratio between low consumptions and ultra-efficiency has addressed us to top brightness levels

6.43:1 zoom ratio - zoom magnification from 7x to 45x

Purposely designed for professional routine inspections, the total magnification can be even extended to 180x with 20x eyepieces and 2x additional lens, obtaining an excellent results in this class



Ultra-flat base with Ø 100 mm disc for diffused transmitted light

A new level of ergonomics and comfort is achieved during operations, with the ultra-flat base of only 3 cm height to ensure smooth specimen movement and the Ø 100 mm for top class diffusion of the transmitted light

Stereomicroscopes For Higher Education & Laboratory



Longlife LED illumination (providing over 20 years of use)

Money & energy saving thanks to LED long lifetime (65.000 hours, 22 years in case of 8 hours/day) which is more than 20 times compared to a standard halogen bulb

Cordless use, totally independent from mains/batteries connection

All models work with or without the batteries in place and are provided with three NiMH rechargeable batteries for the longest autonomy in outdoor use (12-hour autonomy, at medium intensity)



External power supply for enhanced safety and convenient servicing

OPTIKA's safety first approach drives to the use of a low voltage, multi-plug, external power supply in order to prevent any risk of electric shock and heatflow inside the unit

SLX Series - Get the most out of our accessories

Additional Lenses

Simply to be screwed into the threads below the objectives of SLX-2 and SLX-3 to either increase or decrease total magnification, or to increase the working distance when users need to work with hands under the microscope



ST-091 - Additional lens 0.75x

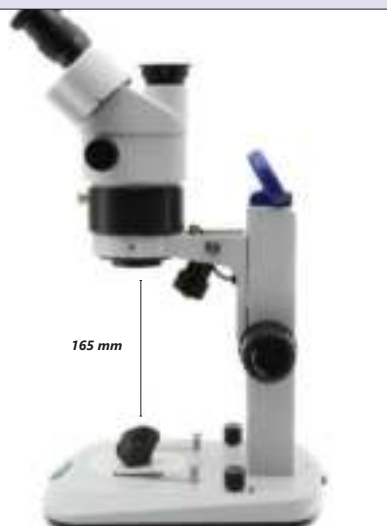

ST-085.1 - Additional lens 0.5x (w.d. 165mm) with SZ-EXT

ST-040.1 - Darkfield condenser

This is a darkfield condenser for stereo microscopes with bottom light and 100 mm round working plate to provide darkfield microscopy features, fitting all OPTIKA stereomicroscopes with 100 mm mounting size and transmitted light



ST-040.1 - Darkfield condenser, 100mm diameter

SLX-1



Cordless binocular stereomicroscope ideal for industrial purposes and students/amateurs to dissect and discover mainly biology and materials science in 3D, with turnable objective (2x-4x), FN 21 high eyepoint eyepieces, precision fixed arm with handle and the latest technology of EcoLED™ illumination plus rechargeable batteries. Slim and easy to carry, it is equipped with long lasting LED illumination to provide over 20 years of use

Head: Binocular, 45° inclined; 360° rotating.

Dioptric adjustment: Left eyepiece.

Eyepieces: WF10x/21 mm, high eyepoint, secured by screw and with rubber cups.

Objective: Achromatic 2x-4x with anti-fungus treatment.

Working distance: 100 mm.

Stand: High-grade, precision fixed with handle and focus.

Focusing: Rack and pinion focusing mechanism.

Illumination: EcoLED™ swiveling incident and transmitted, with brightness control, rechargeable batteries. Color temperature: 6,300 K. Multi-plug 100-240Vac/5Vdc external power supply.

SLX-2



Cordless binocular stereozoom microscope ideal for industrial purposes and students/amateurs to dissect and discover mainly biology and materials science in 3D, with 0.7x...4.5x zoom, FN 21 high eyepoint eyepieces, precision fixed arm with handle and the latest technology of EcoLED™ illumination plus rechargeable batteries. Slim and easy to carry, it is equipped with long lasting LED illumination to provide over 20 years of use

Head: Binocular, 45° inclined; 360° rotating.

Dioptric adjustment: Both eyepieces.

Eyepieces: WF10x/21 mm, high eyepoint, secured by screw and with rubber cups.

Objective: Parfocal achromatic zoom 0.7x...4.5x (6.43:1 ratio) with anti-fungus treatment.

Working distance: 100 mm.

Stand: High-grade, precision fixed with handle and focus.

Focusing: Rack and pinion focusing mechanism.

Illumination: EcoLED™ swiveling incident and transmitted, with brightness control, rechargeable batteries. Color temperature: 6,300 K. Multi-plug 100-240Vac/5Vdc external power supply.

SLX Series - Range

SLX-3

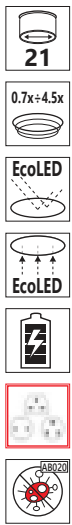

Cordless trinocular stereozoom microscope ideal for industrial purposes and students/amateurs to dissect and discover mainly biology and materials science in 3D, with 0.7x...4.5x zoom, FN 21 high eyepoint eyepieces, precision fixed arm with handle and the latest technology of EcoLED™ illumination plus rechargeable batteries. Slim and easy to carry, it is equipped with long lasting LED illumination to provide over 20 years of use

Head: Trinocular (split ratio: 50/50), 45° inclined; 360° rotating.

Dioptric adjustment: Both eyepieces.

Eyepieces: WF10x/21 mm, high eyepoint, secured by screw and with rubber cups.

Objective: Parfocal achromatic zoom 0.7x...4.5x (6.43:1 ratio) with anti-fungus treatment.

Working distance: 100 mm.

Stand: High-grade, precision fixed with handle and focus.

Focusing: Rack and pinion focusing mechanism.

Illumination: EcoLED™ swiveling incident and transmitted, with brightness control, rechargeable batteries. Color temperature: 6,300 K. Multi-plug 100-240Vac/5Vdc external power supply.

SLX Series - Comparison Chart

Model	Head	Eyepieces	Objective	Working Distance	Stand	Illumination
SLX-1	Binocular 45° inclined 360° rotating	WF 10x/21	2x – 4x selectable	100 mm	High-grade, precision fixed with handle and focus	EcoLED™ swiveling incident and transmitted with brightness control, rechargeable batteries
SLX-2	Binocular 45° inclined 360° rotating	WF 10x/21	0.7x...4.5x zoom	100 mm	High-grade, precision fixed with handle and focus	EcoLED™ swiveling incident and transmitted with brightness control, rechargeable batteries
SLX-3	Trinocular (50/50) 45° inclined 360° rotating	WF 10x/21	0.7x...4.5x zoom	100 mm	High-grade, precision fixed with handle and focus	EcoLED™ swiveling incident and transmitted with brightness control, rechargeable batteries

Optical performance SLX-1

Eyepiece	10x (ST-081)		15x (ST-082)		20x (ST-083)		10x (ST-084)	
	21		15		10		21	
Field number (mm)	21		15		10		21	
Additional lens	Total magnification	Field of View (mm)	Total magnification	Field of View (mm)	Total magnification	Field of View (mm)	Total magnification	Field of View (mm)
1x	20x - 40x	10.50 - 5.25	30x - 60x	7.50 - 3.75	40x - 80x	5.00 - 2.50	20x - 40x	10.50 - 5.25

Optical performance SLX-2 - SLX-3

Eyepiece	10x (ST-081)		15x (ST-082)		20x (ST-083)		10x (ST-084)	
	21		15		10		21	
Field number (mm)	21		15		10		21	
Additional lens	Total magnification	Field of View (mm)	Total magnification	Field of View (mm)	Total magnification	Field of View (mm)	Total magnification	Field of View (mm)
0.5x	3.5x - 22.5x	60.00 - 9.33	5.25x - 33.75x	42.86 - 6.67	7x - 45x	28.57 - 4.44	3.5x - 22.5x	60.00 - 9.33
0.75x	5.25x - 33.75x	40.00 - 6.22	7.875x - 50.625x	28.57 - 4.44	10.5x - 67.5x	19.05 - 2.96	5.25x - 33.75x	40.00 - 6.22
1x	7x - 45x	30.00 - 4.67	10.5x - 67.5x	21.43 - 3.33	14x - 90x	14.29 - 2.22	7x - 45x	30.00 - 4.67
1.5x	10.5x - 67.5x	20.00 - 3.11	15.75x - 101.25x	14.29 - 2.22	21x - 135x	9.52 - 1.48	10.5x - 67.5x	20.00 - 3.11

SLX Series - Accessories

Eyecups & Eyepieces

ST-036	Eyecups (pair), flat
ST-081	EW10x/21 eyepieces (pair), high eyepoint, with rubber cup
ST-082	WF15x/15 eyepieces (pair), high eyepoint
ST-083	WF20x/10 eyepieces (pair), high eyepoint
ST-084	WF10x/21 micrometric eyepiece, high eyepoint, with rubber cup

Additional Lenses

ST-085.1	Additional lens 0.5x (w.d. 165mm) with SZ-EXT (only for SLX-2 & SLX-3)
ST-091	Additional lens 0.75x (w.d. 105mm) (only for SLX-2 & SLX-3)
ST-086.1	Additional lens 1.5x (w.d. 45mm) with compensating disc (only for SLX-2 & SLX-3)

Stages

ST-100.1	Hand moving stage, 100mm diameter
ST-110.1	Moving stage, coaxial knobs, 100mm diameter
ST-111.1	Moving stage, micrometric screws, 100mm diameter

Condensers & Filters

ST-040.1	Darkfield condenser, 100mm diameter
ST-088.1	Polarising set (filters and rotating stage), 100mm diameter

Camera Adapters

M-113.1	Ring adapter, 30mm (for monocular and binocular microscopes)
M-115	0.35x C-Mount projection lens
M-114	0.5x C-Mount projection lens
M-118	0.75x C-Mount projection lens
M-173	C-Mount projection lens for APS-C/full frame reflex cameras (trino)
M-699	Universal adapter for C-Mount projection lens (trino)
M-620	0.35x focusable C-Mount adapter
M-620.1	0.5x focusable C-Mount adapter
M-620.2	0.65x focusable C-Mount adapter
M-620.3	1x focusable C-Mount adapter

Miscellaneous

15104	Cleaning kit
DC-002	Plastic dust cover, medium, 490(l)x490(h) mm
M-005	Micrometric slide, 26x76mm, with 2 scales (1mm/100 & 10mm/100)
ST-041	Sample clip
ST-042	White/black object-plate, 100mm diameter
ST-043	Glass object-plate, 100mm diameter
ST-092	Protective glass for stereohead
VP-SLX	IQ/OQ/PQ manual for SLX series
AB-020	Antibacterial surface treatment, only for newly purchased microscope

15104 - Cleaning kit

It cleans glass quickly and effectively, without leaving residue or odor. Ideal for precision lens or prism cleaning.



How to connect the cameras to our microscopes.

Please refer to the Adapter reference list on Digital section.

v 7.5 - OPTIKA reserves the right to make corrections, modifications, enhancements, improvements and other changes to its products at any time without notice.

Headquarters and Manufacturing Facilities

OPTIKA® S.r.l. Via Rigla, 30 - 24010 Ponteranica (BG) - ITALY - Tel.: +39 035.571.392 - info@optikamicroscopes.com

Optika Sales branches

OPTIKA® Spain spain@optikamicroscopes.com
OPTIKA® China china@optikamicroscopes.com
OPTIKA® India india@optikamicroscopes.com

OPTIKA® North America namerica@optikamicroscopes.com
OPTIKA® Central America camerica@optikamicroscopes.com
OPTIKA® Africa africa@optikamicroscopes.com

OPTIKA[®]
M I C R O S C O P E S
I T A L Y





























LABORATORY Microscopes

LABORATORY Microscopes

B-290 SERIES - Entry-Level Lab Upright Microscopes	page 81
B-380 SERIES - Middle-Level Routine Lab Upright Microscopes	page 97
B-510 SERIES - Advanced Routine Lab Upright Microscopes	page 121
B-810/B-1000 SERIES - Research Lab Upright Microscopes	page 147
IM-300 SERIES - Routine Lab Inverted Microscopes	page 193
IM-5 SERIES - Routine & Research Lab Inverted Microscopes	page 211
IM-7 MODEL - Inverted Research Microscope	page 231
POL SERIES - Routine & Research Lab Polarizing Microscopes	page 243
FLUO SERIES - Routine & Research Lab Fluorescence Microscopes	page 253
SZR-180 MODEL - Research Stereomicroscope	page 275

Icons

	Field number		W-Plan objectives (up to 22mm f.o.v)		Tablet screen size
	Incident light		U-Plan objectives (up to 24mm f.o.v)		Camera resolution
	Transmitted light		Oil/Water 100x objective		Software included
	LED illuminator		Fluorescence		HDMI output
	X-LED illuminator		Metallography		MicroSD slot
	Automatic light control		Polarized light		Wi-Fi
	Multi-Plug low voltage power supply		Darkfield		BlueTooth
	Infinity corrected optics		Phase contrast		IVD Available *
	N-Plan objectives (up to 20mm f.o.v)		USB connection		Antibacteria treatment available

* The IVD code must be requested at order

OPTIKA[®]
M I C R O S C O P E S
I T A L Y

B-290 Series



Entry-Level Lab Upright Microscopes

Best Value-for-Money Solutions & Versatile Use

SUITABLE FOR UNIVERSITIES, EXPERTS & ROUTINE LABS

- » The ideal choice for common lab requirements
- » Simply engineered for life-science
- » Ready for phase contrast and darkfield

EXCELLENT PRICE/PERFORMANCE RATIO

- » N-PLAN objectives (160 mm or IOS) for flat images on 20 mm FN
- » Fixed Koehler illumination for crisp and contrasted images
- » Rounded edge, rackless stage to prevent scratches



B-290TB - BREAK NEW GROUND WITH WINDOWS TABLET

- » Large touch-screen of 10.1" with fast, responsive and smooth control
- » 360° rotatable, tiltable and easily detachable
- » Simultaneous camera & power connection for long-term operation

B-290LD SERIES - ON-FIELD TBC & MALARIA DIAGNOSIS

- » Ultra-convenient LED fluorescence, blue filter
- » No waiting time, immediate operation
- » Cost-effective, money-saving technology

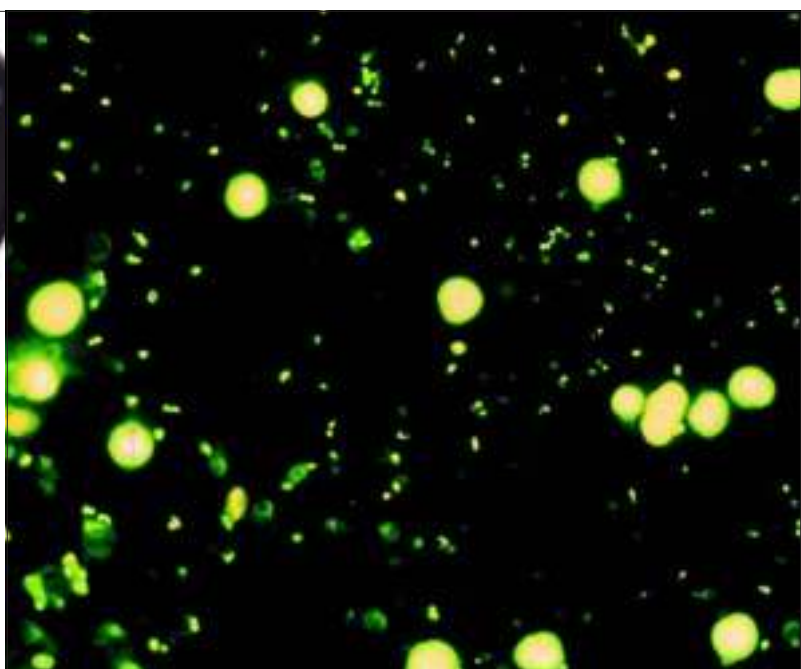

100x Oil/Water Objective – Only at OPTIKA

2

SAME OBJECTIVE FOR OIL AND WATER USE

- » Oil represents the best media for high numerical aperture
- » Water combines results with convenience
- » Water is recommended especially for educational purposes

UNPARALLELED TIME & MONEY SAVING

- » Save time by forgetting about tedious cleaning
- » No time-wasting procedures for maintenance
- » No additional expenses due to inappropriate cleaning

Laboratory

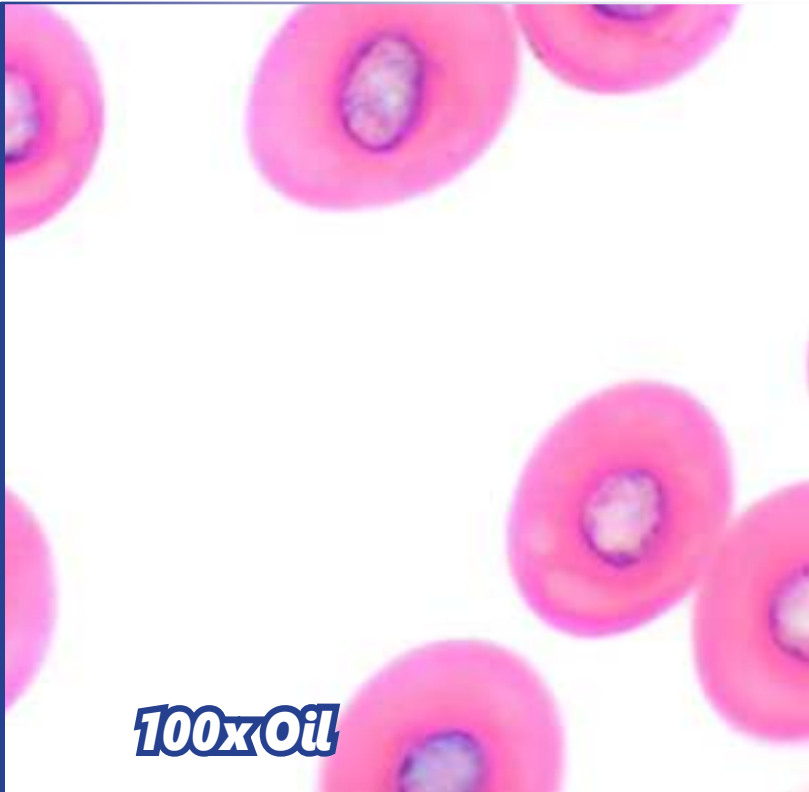

100x Oil



100x Water

X-LED³ – Only Available at OPTIKA

STATE-OF-THE-ART ILLUMINATION SYSTEM

- » Uncomparable light intensity, exclusive lens & collector design
- » Constant pure-white colour temperature at all intensity levels
- » Unmatched color fidelity, uniformity and brightness

CUT ELECTRICITY BILLS BY 90%

- » Money & energy saving, only 3.6 W
- » More efficient brightness than a 50 W halogen lamp
- » LED long lifetime (65,000 hours = 22 years at 8 hours/day usage)

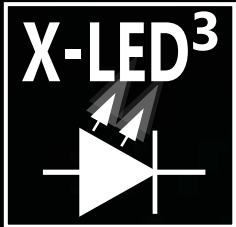

Multi-plug power supply

IOS & Professional Features

2

LABORATORY GRADE OPTICS FOR OUTSTANDING IMAGES

- » Planachromatic optics
- » Designed to ensure field flatness on 20 mm (N-PLAN)
- » IOS Infinity corrected optical system

FULL CONTROL OF YOUR IMAGES

- » Fully settable condenser for perfect imaging
- » Easy to set objective-coded iris diaphragm, focusable & centrabale
- » Phase contrast and darkfield slider available

Laboratory



B-290 Series

This series incorporates all the experience gathered by OPTIKA Microscopes in the field of light microscopy, adapted specifically for common laboratory applications. Suitable for routine microscopy with brightfield, darkfield, phase contrast and LED fluorescence, designed to last.

X-LED³ Exclusive Lighting Source

Special technology able to double the light intensity for incomparable performance, ensuring constant pure-white colour temperature (6,300K colour temperature). Relevant money and energy saving thanks to the incredibly low energy consumptions which allows you to cut the electricity bills by 90%!
The electric consumption (3.6 W only) proves the high efficiency of this system: incredibly high light intensity combined with low consumption.

Safe And Convenient Operations

Rounded edge rackless stage has been designed with a belt-driven mechanism that allows a smooth movement without any protruding part.
This design gives you a more compact solution and lowers any risk of injury after accidentally hitting the rack with your hands.

Clear Observation With 100x Objective

Students and basic users will enjoy B-290 Series for the clear and sharp images they can get using 100x objective with water, thanks to the extremely bright X-LED³ light source and the fully centerable Abbe condenser. Forget about the tedious lens cleaning you are used to when using 100x objective: dirt and dust will not affect your objective.



Pine, one year stem.

For a professional use, immersion oil is the recommended solution to get the best performance available from any 100x objective.



Entry-Level Lab Upright Microscopes

Laboratory Grade Optics, N-PLAN & IOS N-PLAN System

OPTIKA N-PLAN objectives ensure bright, clear images with excellent flatness and compensation for chromatic aberration. IOS Infinity-corrected optical system prevents image deterioration even if other optical components are added, such as polarizers, beamsplitters and so on.

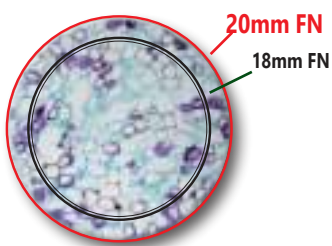

Large Specimen View (20 mm Field Number)

The **F.O.V.** (field of view) is based on a comfortable diameter of 20 mm. This means that a wide area of the sample can be inspected and allows a natural and easy view, particularly needed in a laboratory environment.

Easy Transportation

B-290 has a carefully shaped design that gives stability and ease in the transportation. Thanks to the handle on the back, it can be safely moved around the classroom or the laboratory.



Get the most out of our accessories



M-666.290 Heating stage

Use the temperature controlled heating stage for specific applications where accurate temperature selection up to 50° C and programmable settings are needed. Requested in research arenas such as microbiology, biochemistry, material science, pharmacology, crystallographic characterization, surface quality control, and in all the temperature related inspections.

M-184 Darkfield condenser

With optional diaphragm M-184 you can easily obtain a darkfield view for dry objectives. M-184 can be placed directly under the condenser without the need of additional operations.



DARKFIELD CONDENSER

B-290 Series

Legend

1. B-290TB with 360° rotating tablet PC for discussion.
2. Pine, one year stem, with B-292 and 10x objective.
3. B-290 Series exclusive X-LED³ illumination system.
4. B-293 used by a teacher.
5. Lilly pollen, with B-292PLi and 20x objective.
6. Ascaris female, with B-293 and 40x objective.
7. Student setting the right focusing on a B-290TB.

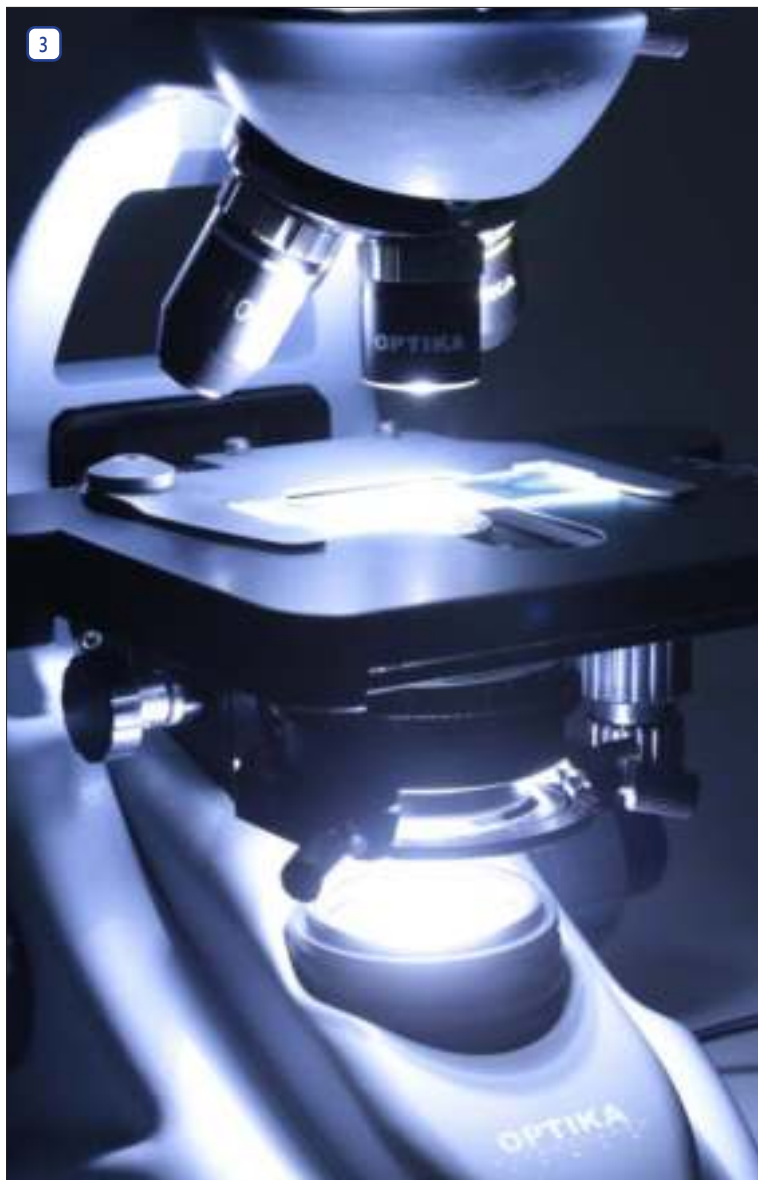
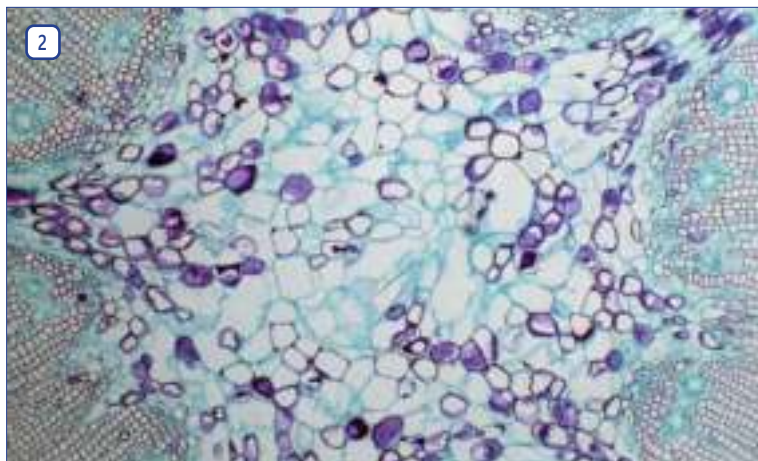

Entry-Level Lab Upright Microscopes

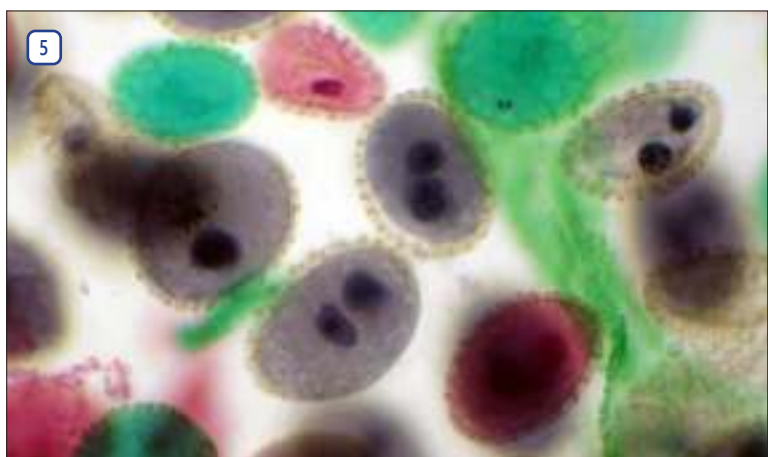

2 B-290 Series - Brightfield Models

B-292



Binocular head with N-PLAN objectives, rackless stage and exclusive **X-LED³** for unmatched performance, powerful and uniform illumination.

Observation mode: Brightfield.

Head: Binocular, 30° inclined and 360° rotating. Interpupillary distance 48-75 mm.

Dioptric adjustment: On both eyepieces.

Eyepieces: WF10x/20 mm, high eye-point and secured by screw.

Nosepiece: Quadruple revolving nosepiece, rotation on ball bearings.

Objectives:

N-PLAN 4x/0.10 N-PLAN 10x/0.25
N-PLAN 40x/0.65 N-PLAN 100x/1.25 (Oil/Water)

All with anti-fungus treatment.

Specimen stage: Double layer rackless mechanical sliding stage, 150x139 mm, 75x33 mm X-Y movement range. Vernier scale on the two axes, accuracy: 0.1 mm.

Focusing: Coaxial coarse and fine focusing mechanism with limit stop to prevent the contact between objective and specimen. Adjustable tension of coarse focusing knob.

Condenser: Abbe N.A. 1.25, with objective-coded iris diaphragm, focusable and centerable.

Illumination (Fixed Koehler type): X-LED³ with white 3.6 W LED (6,300 K) and light intensity control. Multi-plug 100-240Vac/6Vdc external power supply.

B-293



Trinocular head with N-PLAN objectives, rackless stage and exclusive **X-LED³** for unmatched performance, powerful and uniform illumination.

Observation mode: Brightfield.

Head: Trinocular (fixed, 50/50), 360° rotating and 30° inclined. Interpupillary distance 55-75 mm.

Dioptric adjustment: On both eyepieces.

Eyepieces: WF10x/20 mm, high eye-point and secured by screw.

Nosepiece: Quadruple revolving nosepiece, rotation on ball bearings.

Objectives:

N-PLAN 4x/0.10 N-PLAN 10x/0.25
N-PLAN 40x/0.65 N-PLAN 100x/1.25 (Oil/Water)

All with anti-fungus treatment.

Specimen stage: Double layer rackless mechanical sliding stage, 150x139 mm, 75x33 mm X-Y movement range. Vernier scale on the two axes, accuracy: 0.1 mm.

Focusing: Coaxial coarse and fine focusing mechanism with limit stop to prevent the contact between objective and specimen. Adjustable tension of coarse focusing knob.

Condenser: Abbe N.A. 1.25, with objective-coded iris diaphragm, focusable and centerable.

Illumination (Fixed Koehler type): X-LED³ type with white 3.6 W LED (6,300 K) and light intensity control. Multi-plug 100-240Vac/6Vdc external power supply.

B-290 Series - Brightfield Models

B-292PLi



Binocular head with IOS N-PLAN (infinity corrected) objectives, rackless stage and exclusive **X-LED³** for incredibly bright illumination.

Observation mode: Brightfield.

Head: Binocular, 360° rotating and 30° inclined. Interpupillary distance 48-75 mm.

Dioptric adjustment: On both eyepieces.

Eyepieces: WF10x/20 mm, high eye-point and secured by screw.

Nosepiece: Quadruple revolving nosepiece, rotation on ball bearings.

Objectives:

IOS N-PLAN 4x/0.10	IOS N-PLAN 10x/0.25
IOS N-PLAN 40x/0.65	IOS N-PLAN 100x/1.25 (Oil/Water)

All with anti-fungus treatment.

Specimen stage: Double layer rackless mechanical sliding stage, 150x139 mm, 75x33 mm X-Y movement range. Vernier scale on the two axes, accuracy: 0.1 mm.

Focusing: Coaxial coarse and fine focusing mechanism with limit stop to prevent the contact between objective and specimen. Adjustable tension of coarse focusing knob.

Condenser: Abbe N.A. 1.25, with objective-coded iris diaphragm, focusable and centerable.

Illumination (Fixed Koehler type): X-LED³ type with white 3.6 W LED (6,300 K) and light intensity control.
Multi-plug 100-240Vac/6Vdc external power supply.

B-293PLi



Trinocular head with IOS N-PLAN (infinity corrected) objectives, rackless stage and exclusive **X-LED³** for incredibly bright illumination.

Observation mode: Brightfield.

Head: Trinocular (fixed, 50/50), 360° rotating and 30° inclined. Interpupillary distance 55-75 mm.

Dioptric adjustment: On both eyepieces.

Eyepieces: WF10x/20 mm, high eye-point and secured by screw.

Nosepiece: Quadruple revolving nosepiece, rotation on ball bearings.

Objectives:

IOS N-PLAN 4x/0.10	IOS N-PLAN 10x/0.25
IOS N-PLAN 40x/0.65	IOS N-PLAN 100x/1.25 (Oil/Water)

All with anti-fungus treatment.

Specimen stage: Double layer rackless mechanical sliding stage, 150x139 mm, 75x33 mm X-Y movement range. Vernier scale on the two axes, accuracy: 0.1 mm.

Focusing: Coaxial coarse and fine focusing mechanism with limit stop to prevent the contact between objective and specimen. Adjustable tension of coarse focusing knob.

Condenser: Abbe N.A. 1.25, with objective-coded iris diaphragm, focusable and centerable.

Illumination (Fixed Koehler type): X-LED³ type with white 3.6 W LED (6,300 K) and light intensity control.
Multi-plug 100-240Vac/6Vdc external power supply.

B-290TB - Digital Microscope with Camera & Tablet

B-290TB

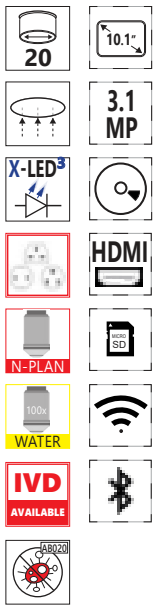

3.1 MP Built-in camera and 10.8" Windows tablet PC with N-PLAN objectives, rackless stage and exclusive **X-LED³** for unmatched performance in illumination. Ideal for discussion group with 360° rotating tablet.

Observation mode: Brightfield.

Head: Binocular, 360° rotating and 30° inclined. Interpupillary distance from 48 to 75 mm; dioptic adjustment on left eyepiece. Built-in 3.1 MP camera.

Dioptic adjustment: On the left eyepiece tube.

Eyepieces: WF10x/20 mm, high eye-point and secured by screw.

Nosepiece: Quadruple revolving nosepiece, rotation on ball bearings.

Objectives:

N-PLAN 4x/0.10

N-PLAN 10x/0.25

N-PLAN 40x/0.65

N-PLAN 100x/1.25 (Oil/Water)

All with anti-fungus treatment.

Specimen stage: Double layer rackless mechanical sliding stage, 150x139 mm, 75x33 mm X-Y movement range. Vernier scale on the two axes, accuracy: 0.1 mm.

Focusing: Coaxial coarse and fine focusing mechanism with limit stop to prevent the contact between objective and specimen. Adjustable tension of coarse focusing knob.

Condenser: Abbe N.A. 1.25, with objective-coded iris diaphragm, focusable and centerable.

Illumination (Fixed Koehler type): X-LED³ type with white 3.6 W LED (6,300 K) and light intensity control. Multi-plug 100-240Vac/6Vdc external power supply.



UNIQUE FEATURES

- » Simultaneous camera & power connection
- » Equipped with the latest Windows OS & Intel processor
- » Easily detachable, can be used as a laptop (keyboard sold separately)

B-290TB - Digital Microscope with Camera & Tablet

The latest OPTIKA digital microscopes with Windows tablet PC open new microscopy horizons, combining high-end optics with innovative digital technology for microscopic imaging. B-290TB includes a 3MP camera with a 10.1" Windows tablet. View, capture, analyze and share your images with simplicity and reliability.

TABLET TECHNICAL SPECIFICATIONS

Operating system	Windows 10 (64Bit)
CPU	Intel® Celeron, N3350
CPU speed	1.10 GHz
Graphic card	Intel® HD Graphics 500
RAM	Ram 6 GB DDR3
Display size	LED 10.1" IPS Multi Touch Screen
Display resolution	1920x1200
Storage	Hdd 64 GB
Network	802.11b/g/n/ac,2.4GHz+5.0GHz
Input ports	USB 3.0, Type C, Micro SD card reader, Microphone, DC in
Output ports	Headphone - Micro HDMI
Battery Type	Lithium-ion
Battery capacity	3500 mAh
Power consumption	24.05W
Power supply	12V 2A EU / US
Dimensions (mm)	247 x 165 X 9
Weight (Kg)	0.57
Language	Multilanguage

Intuitive, Yet Powerful Software

Simple and user-friendly, ideal for students and experienced users.



360° Rotating & Tilting



CAMERA TECHNICAL SPECIFICATIONS

Camera resolution (n° of pixels):	3MP
Signal output	USB 2.0
Sensor Size	1/2.5"
Sensor technology	CMOS
Image format	4\3
Full Image size	2048 x 1536
Pixel size	2.2 x 2.2 micron
Frame rate full resolution	5 frames\sec
Frame rate other resolutions	8 fps (1280x1024) - 30 fps (640x480)
Automatic White Balance	Auto - Man
Automatic Gain Control	Auto - Man
Automatic Back light control	Auto - Man
Exposure control	Auto - Man

Detachable



TB-KBD1 - Accessory keyboard for tablet

B-290LD - LED Fluorescence Microscopes

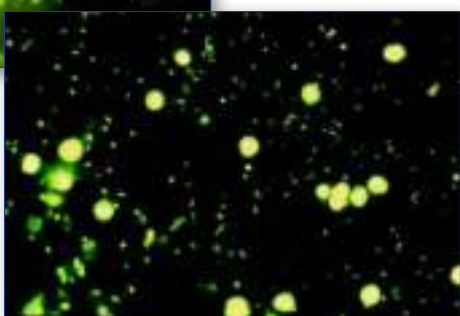
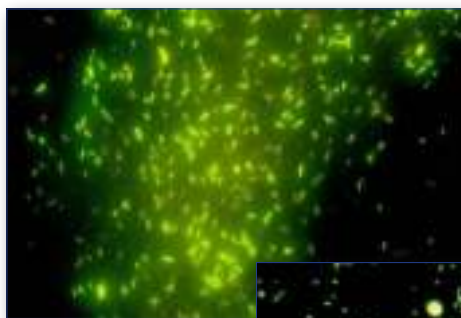

Fluorescence binocular and trinocular microscopes especially designed for tuberculosis and malaria analysis.

Observation mode: Brightfield.

Head: Binocular or trinocular, 360° rotating and 30° inclined. Interpupillary distance 48-75mm (bino version) 55-75mm (trino version).

Dioptric adjustment: On both eyepieces.

Eyepieces: WF10x/20 mm, high eye-point and secured by a screw.

Nosepiece: Quadruple revolving nosepiece, rotation on ball bearings.

Specimen stage: Double layer rackless mechanical sliding stage, 150x139 mm, 75x33 mm X-Y movement range. Vernier scale on the two axes, accuracy: 0.1 mm.

Focusing: Coaxial coarse and fine focusing mechanism with limit stop to prevent the contact between objective and specimen. Adjustable tension of coarse focusing knob.

Condenser: Abbe N.A. 1.25, with objective-coded iris diaphragm, focusable and centerable.

Brightfield Illumination (Fixed Koehler type): X-LED³ with white 3.6 W LED (6,300 K) and light intensity control.

Multi-plug 100-240Vac/6Vdc external power supply.

Fluorescence Illumination: Extra efficiency LED, with light intensity control. Peak wavelength: 465 nm, Power: 3.6W.

Epi Fluorescence Attachment: Slider with 3 positions (2 fluorescence, 1 brightfield), with 1 included filterset: Fluorescence B: EX 460-490, DM 505, EM 515LP: Acridine Yellow, Acridine Orange, Auramine, DiO, DTAF, FITC, GFP, YFP, etc.

Part number: B-292LD1.50

Equipped with binocular head and following objectives:
IOS N-PLAN 10x/0.25 (Cover/No Cover), with anti-fungus treatment
IOS N-PLAN 20x/0.40 (Cover/No Cover), with anti-fungus treatment
IOS N-PLAN 40x/0.65 (Cover/No Cover), with anti-fungus treatment
IOS W-PLAN MET 50x/0.75 (No Cover), with anti-fungus treatment.

Part number: B-293LD1.50

Trinocular version of B-292LD1.50.

Part number: B-292LD1

Equipped with binocular head and following objectives:
IOS N-PLAN 10x/0.25 (Cover/No Cover), with anti-fungus treatment
IOS N-PLAN 20x/0.40 (Cover/No Cover), with anti-fungus treatment
IOS N-PLAN 40x/0.65 (Cover/No Cover), with anti-fungus treatment
IOS W-PLAN 100x/0.80 (No Cover, Dry), with anti-fungus treatment.

Part number: B-293LD1

Trinocular version of B-292LD1.

Standard filterset

Name	Excitation filter (nm)	Dichroic mirror cut-off (nm)	Emission filter (nm)
B (Blue)	460 – 490	505	515LP

B-290 Series - Comparison Chart

Model	Head	Eyepieces	Nosepiece	Objectives	Stage	Focusing	Condenser	Illumination
B-292	Binocular, 30° inclined, 360° rotating	WF 10x/20	Quadruple, reversed	N-PLAN 4x, 10x, 40x, 100x (oil/water)	Double layer, 150x139 mm, moving range 75x33 mm, X-axis rackless	Coaxial coarse and fine, limit stop	Abbe N.A. 1.25, iris diaphragm, focusable and centrabale	3.6 W X-LED ³ , brightness control. Fixed Koehler
B-292PLi	Binocular, 30° inclined, 360° rotating	WF 10x/20	Quadruple, reversed	IOS N-PLAN 4x, 10x, 40x, 100x (oil/water)	Double layer, 150x139 mm, moving range 75x33 mm, X-axis rackless	Coaxial coarse and fine, limit stop	Abbe N.A. 1.25, iris diaphragm, focusable and centrabale	3.6 W X-LED ³ , brightness control. Fixed Koehler
B-293	Trinocular, 30° inclined, 360° rotating	WF 10x/20	Quadruple, reversed	N-PLAN 4x, 10x, 40x, 100x (oil/water)	Double layer, 150x139 mm, moving range 75x33 mm, X-axis rackless	Coaxial coarse and fine, limit stop	Abbe N.A. 1.25, iris diaphragm, focusable and centrabale	3.6 W X-LED ³ , brightness control. Fixed Koehler
B-293PLi	Trinocular, 30° inclined, 360° rotating	WF 10x/20	Quadruple, reversed	IOS N-PLAN 4x, 10x, 40x, 100x (oil/water)	Double layer, 150x139 mm, moving range 75x33 mm, X-axis rackless	Coaxial coarse and fine, limit stop	Abbe N.A. 1.25, iris diaphragm, focusable and centrabale	3.6 W X-LED ³ , brightness control. Fixed Koehler
B-290TB	Binocular, 30° inclined, 360° rotating, with tablet	WF 10x/20	Quadruple, reversed	N-PLAN 4x, 10x, 40x, 100x (oil/water)	Double layer, 150x139 mm, moving range 75x33 mm, X-axis rackless	Coaxial coarse and fine, limit stop	Abbe N.A. 1.25, iris diaphragm, focusable and centrabale	3.6 W X-LED ³ , brightness control. Fixed Koehler

Model	Head	Eyepieces	Nosepiece	Objectives	Stage	Condenser	Fluorescence	Illumination
B-292LD1.50	Binocular, 30° inclined, 360° rotating	WF 10x/20	Quadruple, reversed	IOS N-PLAN 10x, 20x, 40x. W-PLAN MET 50x	Double layer, 150x139 mm, moving range 75x33 mm, X-axis rackless	Abbe N.A. 1.25, iris diaphragm, focusable and centrabale	3.6 W Fluo LED; Blue Filterset	3.6 W X-LED ³ , brightness control
B-292LD1	Binocular, 30° inclined, 360° rotating	WF 10x/20	Quadruple, reversed	IOS N-PLAN 10x, 20x, 40x. W-PLAN 100x (dry)	Double layer, 150x139 mm, moving range 75x33 mm, X-axis rackless	Abbe N.A. 1.25, iris diaphragm, focusable and centrabale	3.6 W Fluo LED; Blue Filterset	3.6 W X-LED ³ , brightness control
B-293LD1.50	Trinocular, 30° inclined, 360° rotating	WF 10x/20	Quadruple, reversed	IOS N-PLAN 10x, 20x, 40x. W-PLAN MET 50x	Double layer, 150x139 mm, moving range 75x33 mm, X-axis rackless	Abbe N.A. 1.25, iris diaphragm, focusable and centrabale	3.6 W Fluo LED; Blue Filterset	3.6 W X-LED ³ , brightness control
B-293LD1	Trinocular, 30° inclined, 360° rotating	WF 10x/20	Quadruple, reversed	IOS N-PLAN 10x, 20x, 40x. W-PLAN 100x (dry)	Double layer, 150x139 mm, moving range 75x33 mm, X-axis rackless	Abbe N.A. 1.25, iris diaphragm, focusable and centrabale	3.6 W Fluo LED; Blue Filterset	3.6 W X-LED ³ , brightness control

Optical performance B-292, B-293 and B-290TB

Eyepiece			10x (M-160)		15x (M-161)		20x (M-162)	
Field number (mm)			20		16		10	
Objective	N.A.	W.D (mm)	Total magnification	Field of View (mm)	Total magnification	Field of View (mm)	Total magnification	Field of View (mm)
4x (N-PLAN 160 mm)	0.10	15.20	40x	5	60x	4	80x	2.5
10x (N-PLAN 160 mm)	0.25	5.50	100x	2	150x	1.6	200x	1
20x (N-PLAN 160 mm)	0.40	5.00	200x	1	300x	0.8	400x	0.5
40x (N-PLAN 160 mm)	0.65	0.45	400x	0.5	300x	0.4	800x	0.25
60x (N-PLAN 160 mm)	0.80	0.13	600x	0.33	900x	0.26	1200x	0.16
100x (N-PLAN 160 mm)	1.25 (oil/water)	0.13	1000x	0.2	1500x	0.16	2000x	0.1

Optical performance B-292PLi, B-293PLi and LD models

Eyepiece			10x (M-160)		15x (M-161)		20x (M-162)	
Field number (mm)			20		16		10	
Objective	N.A.	W.D (mm)	Total magnification	Field of View (mm)	Total magnification	Field of View (mm)	Total magnification	Field of View (mm)
4x (IOS N-PLAN)	0.10	16.80	40x	5	60x	4	80x	2.5
10x (IOS N-PLAN)	0.25	5.80	100x	2	150x	1.6	200x	1
20x (IOS N-PLAN)	0.40	5.10	200x	1	300x	0.8	400x	0.5
40x (IOS N-PLAN)	0.65	0.43	400x	0.5	300x	0.4	800x	0.25
50x (IOS W-PLAN MET, no cover)	0.75	0.32	500x	0.4	750x	0.32	1000x	0.2
60x (IOS N-PLAN)	0.80	0.14	600x	0.33	900x	0.26	1200x	0.16
100x (IOS N-PLAN)	1.25 (oil/water)	0.13	1000x	0.2	1500x	0.16	2000x	0.1
100x (IOS W-PLAN, no cover)	0.80 (dry)	3.20	1000x	0.2	1500x	0.16	2000x	0.1

B-290 Series - Accessories

Eyecups & Eyepieces

M-001	Huygens 5x eyepiece
M-008.1	WF10x/20 eyepiece, high eyepoint, with pointer, rubber cup
M-160	EW10x/20 eyepiece, high eyepoint, with rubber cup
M-161	EW15x/16 eyepiece, with rubber cup
M-162	WF20x/10 eyepiece
M-163	EW10x/20 micrometric eyepiece, high eyepoint, with rubber cup

Objectives

N-PLAN

M-164	N-PLAN objective 4x/0.10
M-165	N-PLAN objective 10x/0.25
M-166	N-PLAN objective 20x/0.40
M-167	N-PLAN objective 40x/0.65
M-168	N-PLAN objective 60x/0.85
M-169	N-PLAN objective 100x/1.25 (oil)

IOS N-PLAN

M-144	IOS N-PLAN objective 4x/0.10
M-145	IOS N-PLAN objective 10x/0.25
M-146	IOS N-PLAN objective 20x/0.40
M-147	IOS N-PLAN objective 40x/0.65
M-149	IOS N-PLAN objective 60x/0.80
M-148	IOS N-PLAN objective 100x/1.25 (oil)

IOS W-PLAN

M-634.1	IOS W-PLAN objective 50x/0.95 (oil)
M-1120.N	IOS W-PLAN PH objective 10x/0.25
M-1121.N	IOS W-PLAN PH objective 20x/0.40
M-1122.N	IOS W-PLAN PH objective 40x/0.65
M-335	IOS W-PLAN MET objective 50x/0.75
M-698.2	IOS W-PLAN MET objective 100x/0.80 (dry)

Stages

M-175	Rotating stage for polarising set (for 150x139mm rackless stage)
M-666.290	Heating stage (on newly purchased microscopes, for 150x139mm stage), multiplug

Condensers & Filters

M-174	Polarising set (filters only)
M-184	Darkfield stop for condenser
M-971	Plane-concave mirror, with base
M-975	Blue filter, 45mm diameter
M-977	Green filter, 45mm diameter
M-979	Yellow filter, 45mm diameter
M-989	Frosted glass filter, 45mm diameter
M-1124.1	Brightfield condenser (with phase slider slot) (except for B-292, B-293 and B-290TB)
M-1124.NO	Phase contrast condenser with insert slide 10x/20x-40x (except for B-292, B-293 and B-290TB)

Camera Adapters

M-114	0.5x C-Mount projection lens
M-115	0.35x C-Mount projection lens
M-118	0.75x C-Mount projection lens
M-173	Photo adapter for APS-C and full frame reflex cameras (trino head)

Miscellaneous

15104	Cleaning kit
15008	Immersion oil, 10ml
15009	Immersion oil, 100ml
DC-002	Plastic dust cover, medium, 490(l)x490(h) mm (except for B-290TB)
DC-003	TNT dust cover, medium, 600(l)x550(h) mm (only for B-290TB)
TB-KBD1	Keyboard for tablet (only for B-290TB)
M-005	Micrometric slide, 26x76mm, with 2 scales (1mm/100 & 10mm/100)
M-069	Solar charger
M-1380	Centering telescope, 23mm diameter (except for B-292, B-293 and B-290TB)
VP-290	IQ/OQ/PQ manual for B-290 series
VP-TB	IQ/OQ/PQ manual for TB series
AB-020	Antibacterial surface treatment, only for newly purchased microscope

M-069 - Solar charger

Included battery: rechargeable – Lithium-Poly.
Capacity: 2500 mAh. - Output voltage: 5 Vdc.
Autonomy: over 6 hours at medium intensity (X-LED³).
Charging models: with solar panel (12h),
with external USB power supply (2.5h)

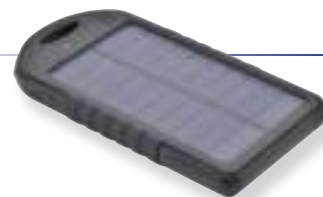

15104 - Cleaning kit

It cleans glass quickly and effectively, without leaving residue or odor. Ideal for precision lens or prism cleaning.



How to connect the cameras to our microscopes.

Please refer to the Adapter reference list on Digital section.

v 7.5 - OPTIKA reserves the right to make corrections, modifications, enhancements, improvements and other changes to its products at any time without notice.

Headquarters and Manufacturing Facilities

OPTIKA® S.r.l. Via Rigla, 30 - 24010 Ponteranica (BG) - ITALY - Tel.: +39 035.571.392 - info@optikamicroscopes.com

Optika Sales branches

OPTIKA® Spain spain@optikamicroscopes.com
OPTIKA® China china@optikamicroscopes.com
OPTIKA® India india@optikamicroscopes.com

OPTIKA® North America namerica@optikamicroscopes.com
OPTIKA® Central America camerica@optikamicroscopes.com
OPTIKA® Africa africa@optikamicroscopes.com

OPTIKA[®]
M I C R O S C O P E S
I T A L Y

B-380 Series



Middle-Level Routine Lab Upright Microscopes

Just What You Need. Right When Is Needed

ROUTINE IN UNIVERSITIES, LABS & INDUSTRIES

- » Wide range to fulfil specific lab requirements
- » Valuable solutions for life and material sciences
- » Compliant with several observation methods

THE PREFERRED PARTNER FOR ROUTINE TASKS

- » Full planarity optics on 20 mm (N-PLAN) according to ISO 19012-1
- » Fixed Koehler illumination for crisp and contrasted images
- » Rounded edge, rackless stage to prevent scratches



Multiple Observation Methods

BRIGHTFIELD

METALLOGRAPHY

DARKFIELD

POLARIZATION

FLUORESCENCE

PHASE CONTRAST

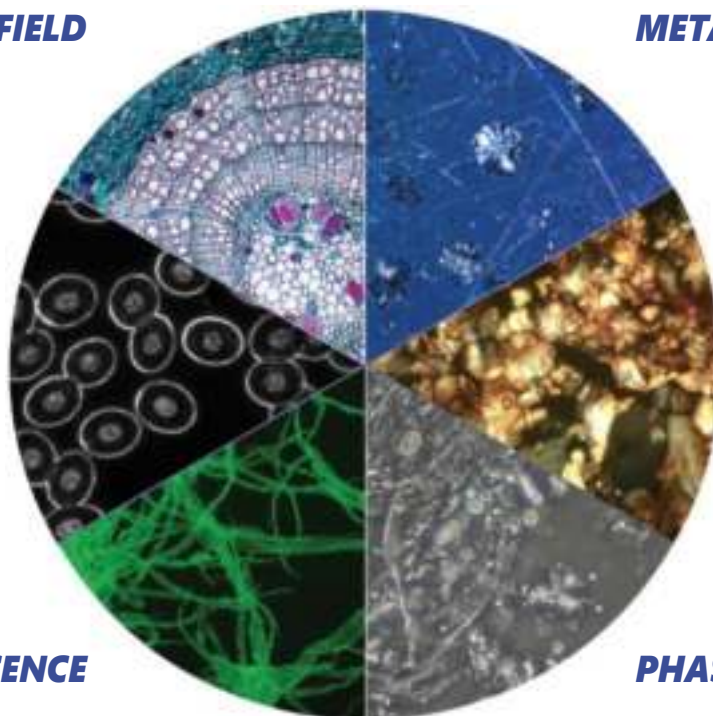

100x Oil/Water Objective – Only at OPTIKA

2

SAME OBJECTIVE FOR OIL AND WATER USE

- » Oil represents the best media for high numerical aperture
- » Water combines results with convenience
- » Water is recommended especially for educational purposes

UNPARALLELED TIME & MONEY SAVING

- » Save time by forgetting about tedious cleaning
- » No time-wasting procedures for maintenance
- » No additional expenses due to inappropriate cleaning

Laboratory

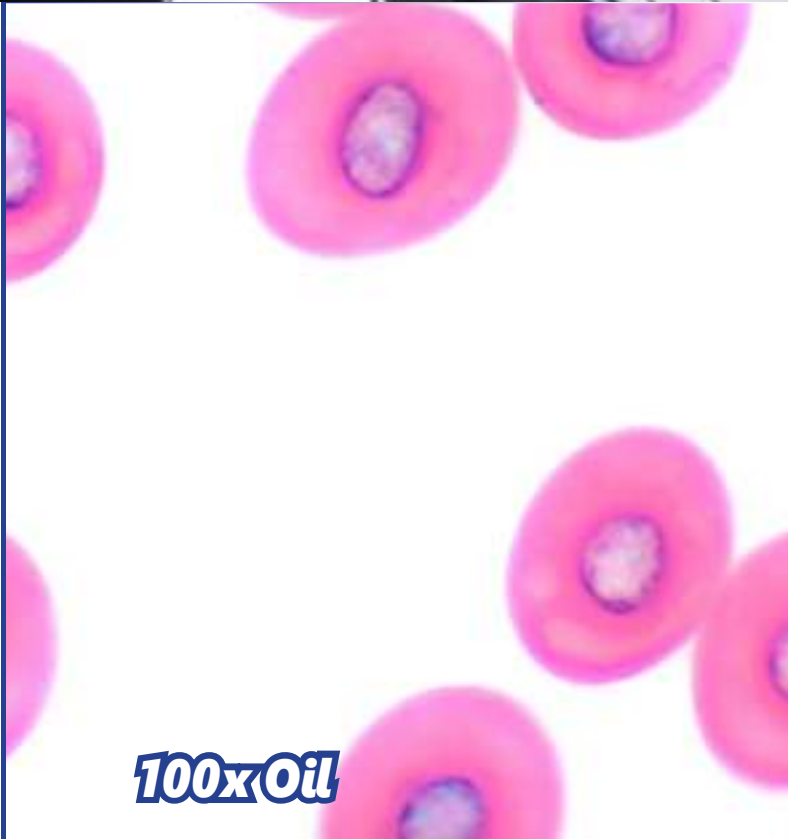

100x Oil

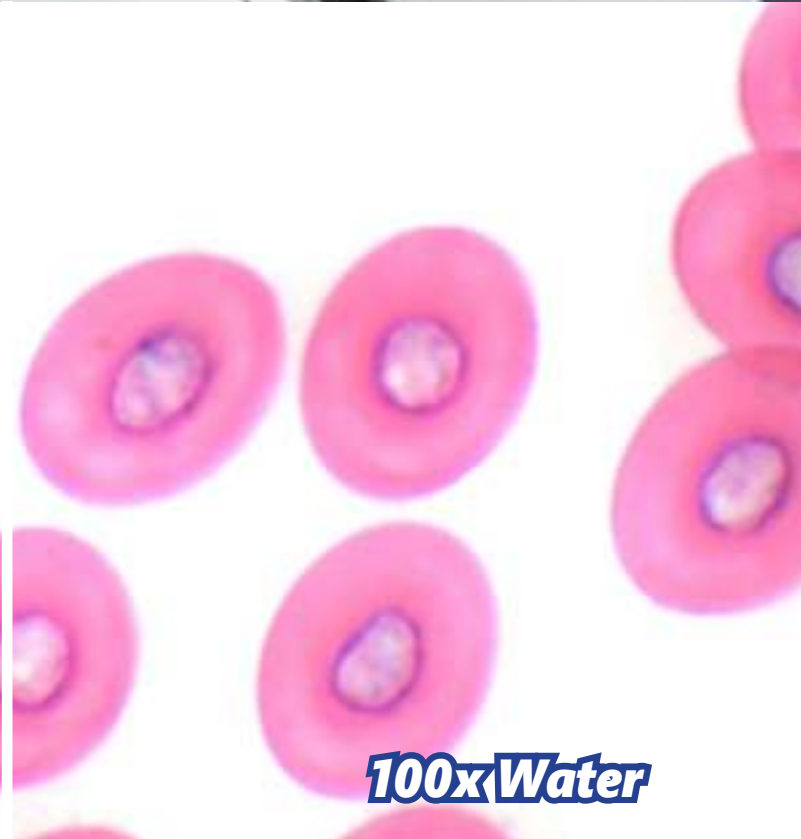

100x Water

X-LED³ – Only Available at OPTIKA

STATE-OF-THE-ART ILLUMINATION SYSTEM

- » Uncomparable light intensity, exclusive lens & collector design
- » Constant pure-white colour temperature at all intensity levels
- » Unmatched color fidelity, uniformity and brightness

CUT ELECTRICITY BILLS BY 90%

- » Money & energy saving, only 3.6 W
- » More efficient brightness than a 50 W halogen lamp
- » LED long lifetime (65,000 hours = 22 years at 8 hours/day usage)



Halogen

X-LED³



Multi-plug power supply

ALC - Only Available At OPTIKA

2

Laboratory

AUTOMATIC LIGHT CONTROL IN 3 STEPS

- » When another objective is used
- » When the diaphragm aperture changes
- » When processing samples with different opacity

FORGET ABOUT MANUAL LIGHT ADJUSTEMENT

- » Choose the light intensity according to your preference
- » Press the ALC button and the brightness is saved
- » The microscope will automatically regulate the light

STEP 1

Set the brightness according to your preferences.



STEP 2

Press the ALC button to save the brightness level.



STEP 3

Forget about the illumination!

The microscope will automatically adjust the brightness for you, in case of:

- Another objective is used
- The diaphragm aperture is changed
- Another specimen with different opacity is processed



B-380 Series

This series incorporates all the experience gathered by OPTIKA Microscopes in the field of light microscopy, adapted specifically for common laboratory applications.

Suitable for routine microscopy with brightfield, darkfield (oil and dry), phase contrast, fluorescence and polarized light, designed to be extremely stable on the bench and last long.

Purposely Designed For Intense Use, Effortless

Full of features that help being more comfortable especially in case of long-term use.

All the main controls are located close to each other to enable minimal movements and reinforce the advantages that the ergonomics brings to this series.

X-LED³ Exclusive Lighting Source

Special technology able to double the light intensity for incomparable performance, ensuring constant pure-white colour temperature (6,300K colour temperature).

Relevant money and energy saving thanks to the incredibly low energy consumptions which allows you to cut the electricity bills by 90%!

The electric consumption (3.6 W only) proves the high efficiency of this system: incredibly high light intensity combined with low consumption.

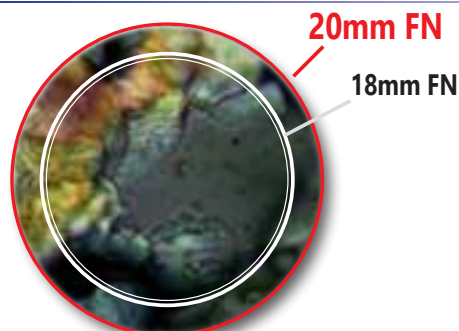

Large Specimen View (20 mm Field Number)

The **F.O.V.** (field of view) is based on a comfortable diameter of 20 mm.

This means that a wide area of the sample can be inspected and allows a natural and easy view, particularly needed in a laboratory environment.

ALC - Automatic Light Control, Only Available At OPTIKA

Incomparable Comfort With The Exclusive Automatic Light Control (ALC)

Light intensity is automatically adjusted by the microscope itself in order to maintain the same level as the one the user has previously chosen.

No matter if the aperture of the diaphragm changes, if another objective is used, and if the opacity of the sample is different...the microscope will set the light for you according to your preferences.

On **ALC Models**.

Safe And Convenient Operations

Rounded edge rackless stage has been designed with a belt-driven mechanism that allows a smooth movement without any protruding part.

This design gives you a more compact solution and lowers any risk of injury after accidentally hitting the rack with your hands.



Middle-Level Routine Lab Upright Microscopes

Universal Condenser For Brightfield, Darkfield & Phase

OPTIKA B-380 phase contrast microscopes are equipped with a 5-position dedicated rotating condenser for brightfield (standard use), phase contrast (10x/20x, 40x and 100x phase diaphragms), and a darkfield position for dry objectives.



Exclusive X-LED³ Darkfield Condenser

The special condenser with integrated, exclusive X-LED³ illuminator replaces any other external and expensive lighting source required for these applications and is ideal for great-looking, rich and high-quality specimen view.

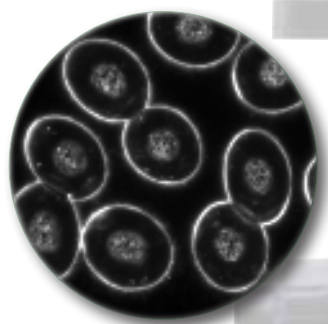

In fluorescence we can offer several options.

According to your application and to the fluorochromes you are using, we can help you to identify the best light source.

Traditional, HBO Fluorescence

- » The most used and diffused method, worldwide
- » Wide spectrum range for future upgrades

Innovative, LED Fluorescence

- » Recommended for routine applications
- » Cost-effective, money saving technology
 - » Ready for immediate operation
 - » Eliminate warm-up/cool-down times
 - » Forget lamp replacement & centering



B-380 Series



10x - Darkfield

M-185
Darkfield condenser (dry)

With M-185 optional condenser you can easily obtain a darkfield view for dry objectives.

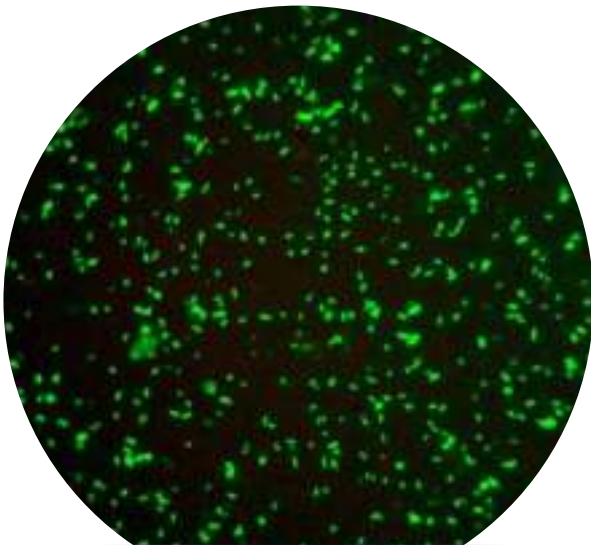

50x - Fluorescence

M-335
Objective 50x/0.75
IOS W-PLAN MET

For applications where no cover slide is required (such as sputum smear analysis for tuberculosis diagnosis), the M-335 objective provides excellent results for stunning images.



Middle-Level Routine Lab Upright Microscopes

Get the most of our accessories

M-181

Complete Phase Contrast Set with IOS W-PLAN PH obj. 10x, 20x, 40x, 100x, with Darkfield position

The B-380 series can be upgraded at any time with phase contrast kits (M-179 with W-PLAN PH objectives and M-181 with IOS W-PLAN PH objectives) including all the components you need to inspect transparent specimens such as microorganisms, thin tissue slices, lithographic patterns, fibers, glass, etc.

M-975.1 Ring with blue filter;

Increase the colour temperature of light (toward the blue).

M-977.1 Ring with green filter;

Optimize the resolution of phase contrast.

M-979.1 Ring with yellow filter;

Decrease the colour temperature of light (toward the red).

M-989.1 Ring with frosted glass filter;

Increase the uniformity of illumination, even further.



Yellow filter



Frosted glass

M-156 Koehler field diaphragm

Additional field diaphragm for upgrading the Fixed Koehler illumination system to a Full Koehler type. To be ordered on newly purchased B-380 microscope.

M-975 Blue filter;

Increase the colour temperature of light (toward the blue).

M-977 Green filter;

Optimize the resolution of phase contrast.

M-979 Yellow filter;

Decrease the colour temperature of light (toward the red).

M-989 Frosted glass filter;

Increase the uniformity of illumination, even further.



B-380 Series

Legend

1. Planachromatic Phase Contrast objectives.
2. Coded iris diaphragm for each objective.
3. B-383POL, tuff observed under polarized light.
4. Tilia three year stem at 4x magnification, B-383PL.
5. B-380 head with built-in Automatic Light Control system.
6. Head with Siedentopf adjustment system.
7. B-383POL attachment with Bertrand lens.
8. Handle for easy and comfortable transportation.
9. Coin at 4x magnification, B-383MET.
10. Coin at 50x magnification, B-383MET.
11. Innovative design of B-380 series.

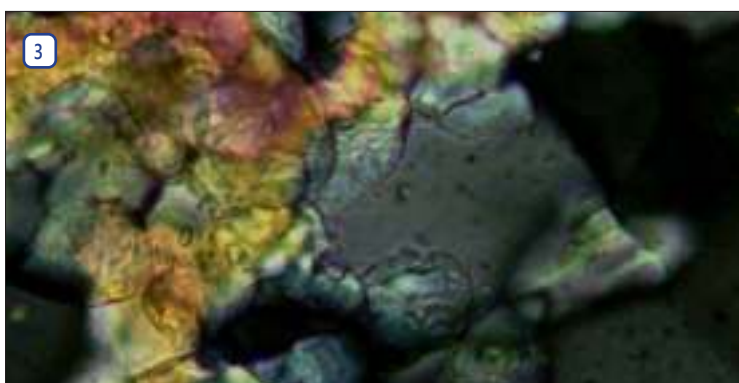

Middle-Level Routine Lab Upright Microscopes

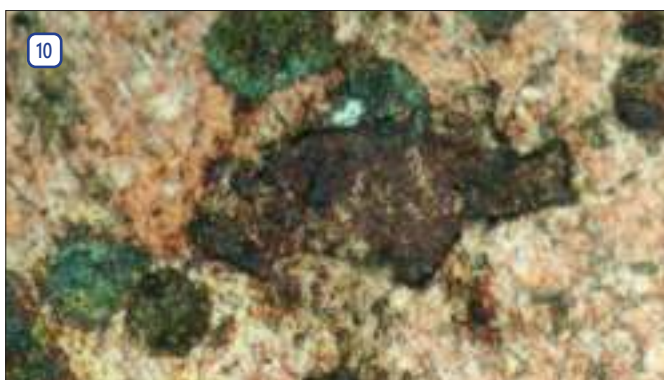

B-380 Series - Brightfield Models

B-382PL-ALC



Brightfield binocular microscope with N-PLAN objectives, rackless stage and combining the exclusive **X-LED³** with **ALC** (Automatic Light Control) for great-looking, rich and high-quality view.

- Observation mode:** Brightfield.
- Head:** Binocular, 30° inclined, 360° rotating (when ALC cable is unplugged).
- Interpupillary distance:** Adjustable between 48 and 75 mm.
- Dioptric adjustment:** On the left eyepiece tube.
- Eyepieces:** WF10x/20 mm, high eye-point and secured by screw.
- Nosepiece:** Quintuple revolving nosepiece, rotation on ball bearings.
- Objectives:**

N-PLAN 4x/0.10	N-PLAN 10x/0.25
N-PLAN 40x/0.65	N-PLAN 100x/1.25 (Oil/Water)

All with anti-fungus treatment.
- Specimen stage:** Double layer rackless mechanical stage, 150x139 mm, 75x33 mm X-Y range.
- Focusing:** Coaxial coarse (adjustable tension) and fine focusing mechanism with limit stop to prevent the contact between objective and specimen.
- Condenser:** Abbe N.A. 1.25, with objective-coded iris diaphragm, focusable and centerable.
- Illumination (Fixed Koehler type):** X-LED³ with white 3.6 W LED (6,300K) and brightness control. **ALC** system.
Multi-plug 100-240Vac/6Vdc external power supply.

B-383PL



Brightfield trinocular microscope with N-PLAN objectives, rackless stage and the exclusive **X-LED³** for great-looking, rich and high-quality view.

- Observation mode:** Brightfield.
- Head:** Trinocular (fixed 50/50), 30° inclined, 360° rotating.
- Interpupillary distance:** Adjustable between 48 and 75 mm.
- Dioptric adjustment:** On the left eyepiece tube.
- Eyepieces:** WF10x/20 mm, high eye-point and secured by screw.
- Nosepiece:** Quintuple revolving nosepiece, rotation on ball bearings.
- Objectives:**

N-PLAN 4x/0.10	N-PLAN 10x/0.25
N-PLAN 40x/0.65	N-PLAN 100x/1.25 (Oil/Water)

All with anti-fungus treatment.
- Specimen stage:** Double layer rackless mechanical stage, 150x139 mm, 75x33 mm X-Y range.
- Focusing:** Coaxial coarse (adjustable tension) and fine focusing mechanism with limit stop to prevent the contact between objective and specimen.
- Condenser:** Abbe N.A. 1.25, with objective-coded iris diaphragm, focusable and centerable.
- Illumination (Fixed Koehler type):** X-LED³ with white 3.6 W LED (6,300K) with brightness control.
Multi-plug 100-240Vac/6Vdc external power supply.

B-380 Series - Brightfield Models

2

Laboratory

B-382PLi-ALC



Brightfield binocular microscope with IOS N-PLAN (Infinity Corrected) objectives, rackless stage and combining the exclusive **X-LED³** with **ALC** (Automatic Light Control) for great-looking, rich and high-quality view.

Observation mode: Brightfield.

Head: Binocular, 30° inclined, 360° rotating (when ALC cable is unplugged).

Interpupillary distance: Adjustable between 48 and 75 mm.

Dioptric adjustment: On the left eyepiece tube.

Eyepieces: WF10x/20 mm, high eye-point and secured by screw.

Nosepiece: Quintuple revolving nosepiece, rotation on ball bearings.

Objectives:

IOS N-PLAN 4x/0.10	IOS N-PLAN 10x/0.25
IOS N-PLAN 40x/0.65	IOS N-PLAN 100x/1.25 (Oil/Water)

All with anti-fungus treatment.

Specimen stage: Double layer rackless mechanical stage, 233x147 mm, 78x54 mm X-Y range.

Focusing: Coaxial coarse (adjustable tension) and fine focusing mechanism with limit stop to prevent the contact between objective and specimen.

Condenser: Abbe N.A. 1.25, with objective-coded iris diaphragm, focusable and centerable.

Illumination (Fixed Koehler type): X-LED³ with white 3.6 W LED (6,300K) and brightness control. **ALC** system. Multi-plug 100-240Vac/6Vdc external power supply.

B-383PLi



Brightfield trinocular microscope with IOS N-PLAN (Infinity Corrected) objectives, rackless stage and the exclusive **X-LED³** for great-looking, rich and high-quality view.

Observation mode: Brightfield.

Head: Trinocular (fixed 50/50), 30° inclined, 360° rotating.

Interpupillary distance: Adjustable between 48 and 75 mm.

Dioptric adjustment: On the left eyepiece tube.

Eyepieces: WF10x/20 mm, high eye-point and secured by screw.

Nosepiece: Quintuple revolving nosepiece, rotation on ball bearings.

Objectives:

IOS N-PLAN 4x/0.10	IOS N-PLAN 10x/0.25
IOS N-PLAN 40x/0.65	IOS N-PLAN 100x/1.25 (Oil/Water)

All with anti-fungus treatment.

Specimen stage: Double layer rackless mechanical stage, 233x147 mm, 78x54 mm X-Y range.

Focusing: Coaxial coarse (adjustable tension) and fine focusing mechanism with limit stop to prevent the contact between objective and specimen.

Condenser: Abbe N.A. 1.25, with objective-coded iris diaphragm, focusable and centerable.

Illumination (Fixed Koehler type): X-LED³ with white 3.6 W LED (6,300K) with brightness control. Multi-plug 100-240Vac/6Vdc external power supply.

B-380 Series - Phase Contrast Models

B-382PH-ALC



Phase contrast, darkfield and brightfield binocular microscope with W-PLAN objectives, rackless stage and combining the exclusive **X-LED³** with **ALC** (Automatic Light Control) for great-looking, rich and high-quality view.

Observation mode: Brightfield, phase contrast and darkfield (dry).

Head: Binocular, 30° inclined, 360° rotating (when ALC cable is unplugged).

Interpupillary distance: Adjustable between 48 and 75 mm.

Dioptric adjustment: On the left eyepiece tube.

Eyepieces: WF10x/20 mm, high eye-point and secured by screw.

Nosepiece: Quintuple revolving nosepiece, rotation on ball bearings.

Objectives:
 N-PLAN 4x/0.10 W-PLAN PH 10x/0.25
 W-PLAN PH 40x/0.65 W-PLAN PH 100x/1.25 (Oil/Water)
 All with anti-fungus treatment.

Specimen stage: Double layer rackless mechanical stage, 150x139 mm, 75x33 mm X-Y range.

Focusing: Coaxial coarse (adjustable tension) and fine focusing mechanism with limit stop to prevent the contact between objective and specimen.

Condenser: Phase condenser (10x/20x, 40x, 100x) with darkfield (dry) and brightfield.

Illumination (Fixed Koehler type): X-LED³ with white 3.6 W LED (6,300K) and brightness control. **ALC** system.
 Multi-plug 100-240Vac/6Vdc external power supply.

B-383PH



Phase contrast, darkfield and brightfield trinocular microscope with W-PLAN objectives, rackless stage and the exclusive **X-LED³** for great-looking, rich and high-quality view.

Observation mode: Brightfield, phase contrast and darkfield (dry).

Head: Trinocular (fixed 50/50), 30° inclined, 360° rotating.

Interpupillary distance: Adjustable between 48 and 75 mm.

Dioptric adjustment: On the left eyepiece tube.

Eyepieces: WF10x/20 mm, high eye-point and secured by screw.

Nosepiece: Quintuple revolving nosepiece, rotation on ball bearings.

Objectives:
 N-PLAN 4x/0.10 W-PLAN PH 10x/0.25
 W-PLAN PH 40x/0.65 W-PLAN PH 100x/1.25 (Oil/Water)
 All with anti-fungus treatment.

Specimen stage: Double layer rackless mechanical stage, 150x139 mm, 75x33 mm X-Y range.

Focusing: Coaxial coarse (adjustable tension) and fine focusing mechanism with limit stop to prevent the contact between objective and specimen.

Condenser: Phase condenser (10x/20x, 40x, 100x) with darkfield (dry) and brightfield.

Illumination (Fixed Koehler type): X-LED³ with white 3.6 W LED (6,300K) with brightness control. Multi-plug 100-240Vac/6Vdc external power supply.

B-380 Series - Phase Contrast Models

2

Laboratory

B-382PHi-ALC



Phase contrast, darkfield and brightfield binocular microscope with IOS W-PLAN (Infinity Corrected) objectives, rackless stage and combining the exclusive **X-LED³** with **ALC** (Automatic Light Control) for great-looking, rich and high-quality view.

Observation mode: Brightfield, phase contrast and darkfield (dry).

Head: Binocular, 30° inclined, 360° rotating (when ALC cable is unplugged).

Interpupillary distance: Adjustable between 48 and 75 mm.

Dioptric adjustment: On the left eyepiece tube.

Eyepieces: WF10x/20 mm, high eye-point and secured by screw.

Nosepiece: Quintuple revolving nosepiece, rotation on ball bearings.

Objectives:

IOS W-PLAN PH 10x/0.25 IOS W-PLAN PH 20x/0.40
IOS W-PLAN PH 40x/0.65 IOS W-PLAN PH 100x/1.25 (Oil)
All with anti-fungus treatment.

Specimen stage: Double layer rackless mechanical stage, 233x147 mm, 78x54 mm X-Y range.

Focusing: Coaxial coarse (adjustable tension) and fine focusing mechanism with limit stop to prevent the contact between objective and specimen.

Condenser: Phase condenser (10x/20x, 40x, 100x) with darkfield (dry) and brightfield.

Illumination (Fixed Koehler type): X-LED³ with white 3.6 W LED (6,300K) and brightness control. **ALC** system. Multi-plug 100-240Vac/6Vdc external power supply.

B-383PHi



Phase contrast, darkfield and brightfield microscope with IOS W-PLAN (Infinity Corrected) objectives, rackless stage and the exclusive **X-LED³** for great-looking, rich and high-quality view.

Observation mode: Brightfield, phase contrast and darkfield (dry).

Head: (50/50), 30° inclined, 360° rotating.

Interpupillary distance: Adjustable between 48 and 75 mm.

Dioptric adjustment: On the left eyepiece tube.

Eyepieces: WF10x/20 mm, high eye-point and secured by screw.

Nosepiece: Quintuple revolving nosepiece, rotation on ball bearings.

Objectives:

IOS W-PLAN PH 10x/0.25 IOS W-PLAN PH 20x/0.40
IOS W-PLAN PH 40x/0.65 IOS W-PLAN PH 100x/1.25 (Oil)
All with anti-fungus treatment.

Specimen stage: Double layer rackless mechanical stage, 233x147 mm, 78x54 mm X-Y range.

Focusing: Coaxial coarse (adjustable tension) and fine focusing mechanism with limit stop to prevent the contact between objective and specimen.

Condenser: Phase condenser (10x/20x, 40x, 100x) with darkfield (dry) and brightfield.

Illumination (Fixed Koehler type): X-LED³ with white 3.6 W LED (6,300K) with brightness control. Multi-plug 100-240Vac/6Vdc external power supply.

B-383DK - Darkfield Microscope

Laboratory upright microscope for brightfield and darkfield observations with N-PLAN objectives (and W-PLAN 100x with iris diaphragm) for biology and especially darkfield fresh blood analysis and the exclusive **X-LED³** illumination system. The special condenser with integrated, exclusive X-LED3 illuminator replaces any other external and expensive lighting source required for these applications and is ideal for great-looking, rich and high-quality specimen view. Our immersion darkfield system provides the same result achieved by 150W external illuminators in combination with traditional cardioid darkfield condenser.

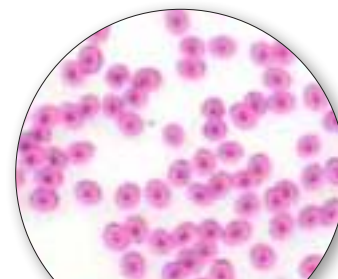

10x

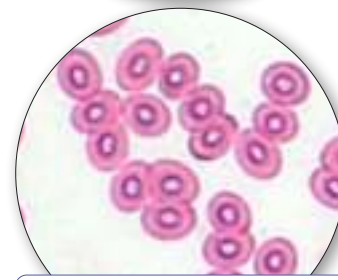

40x

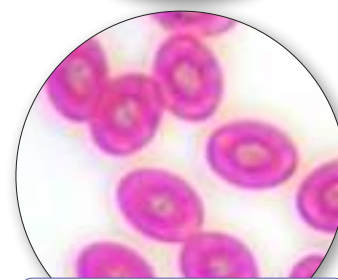

100x Brightfield

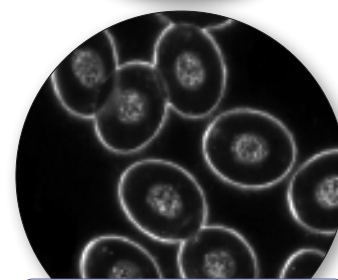

100x Darkfield

Part	Description
Observation mode:	Brightfield, oil immersion darkfield.
Head:	Trinocular (fixed 50/50), 30° inclined, 360° rotating.
Interpupillary distance:	Adjustable between 48 and 75 mm.
Dioptric adjustment:	On the left eyepiece tube.
Eyepieces:	WF10x/20 mm, high eye-point and secured by screw.
Nosepiece	Quintuple revolving nosepiece, rotation on ball bearings.
Objectives:	N-PLAN 4x/0.10 N-PLAN 10x/0.25 N-PLAN 40x/0.65 W-PLAN 100x/1.25 (oil) with iris All with anti-fungus treatment.

Part	Description
Specimen stage:	Double layer rackless mechanical stage, 150x139 mm, 75x33 mm X-Y range.
Focusing:	Coaxial coarse (adjustable tension) and fine focusing mechanism with limit stop to prevent the contact between objective and specimen.
Brightfield condenser:	Abbe N.A. 1.25, with objective-coded iris diaphragm, focusable and centerable.
Darkfieldfield condenser:	Darkfield N.A. 1.36 (oil immersion) with built-in X-LED ³ .
Transmitted illumination (Fixed Koehler type):	X-LED ³ with white 3.6 W LED (6,300K) with brightness control. Multi-plug 100-240Vac/6Vdc external power supply.

B-383FL - HBO Fluorescence Microscope

2

Laboratory

Laboratory upright microscope for brightfield and fluorescence observations with IOS N-PLAN objectives.

The HBO fluorescence illuminator provides an outstanding flexibility of use, standing the blue and green filter sets (supplied as standard) for Auramine, FITC, GFP and YFP (with blue filter set) plus Rhodamine, Texas Red and TRITC (with the green one), yet giving the possibility to combine any other specific filter sets for future upgrade. Transmitted light through the exclusive **X-LED³** to ensure great-looking, rich and high-quality specimen view.



10x - Blue excitation



10x - Green excitation

Standard filterset

Name	Excitation filter (nm)	Dichroic mirror cut-off (nm)	Emission filter (nm)
B Blue	460 – 490	505	515LP
G Green	510 – 550	570	575LP

Part	Description
Observation mode:	Brightfield, HBO fluorescence.
Epi-illumination and filters:	HBO 100 W high pressure mercury lamp. 3-position filter holder; blue and green included.
Head:	Trinocular (fixed 50/50), 30° inclined, 360° rotating.
Interpupillary distance:	Adjustable between 48 and 75 mm.
Dioptric adjustment:	On the left eyepiece tube.
Eyepieces:	WF10x/20 mm, high eye-point and secured by screw.
Nosepiece:	Quintuple revolving nosepiece, rotation on ball bearings.
Objectives:	IOS N-PLAN 4x/0.10 IOS N-PLAN 10x/0.25 IOS N-PLAN 20x/0.40 IOS N-PLAN 40x/0.65 IOS N-PLAN 100x/1.25 (Oil/Water) All with anti-fungus treatment.

Part	Description
Specimen stage:	Double layer rackless mechanical stage, 233x147 mm, 78x54 mm X-Y range.
Focusing:	Coaxial coarse (adjustable tension) and fine focusing mechanism with limit stop to prevent the contact between objective and specimen.
Condenser:	Abbe N.A. 1.25, with objective-coded iris diaphragm, focusable and centerable.
Transmitted illumination (Fixed Koehler type):	X-LED ³ with white 3.6 W LED (6,300K) with brightness control. Multi-plug 100-240Vac/6Vdc external power supply.

B-383LD - LED Fluorescence Microscope

Entry-level laboratory upright microscope for brightfield and fluorescence observations with IOS N-PLAN objectives. The extremely powerful LED fluorescence illuminator is combined with blue excitation filter set for the visualization of the following fluorochromes: Acridine Yellow, Acridine Orange, Auramine, DiO, DTAF, FITC, GFP, YFP, etc. LED fluorescence ensures unparalleled convenience eliminating warm-up/cool-down times and all the inconveniences related lamp replacement and adjustment. Transmitted light through the exclusive **X-LED³** to ensure great-looking, rich and high-quality specimen view.



4x

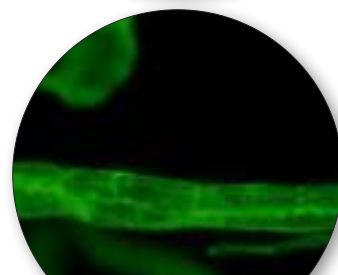

10x

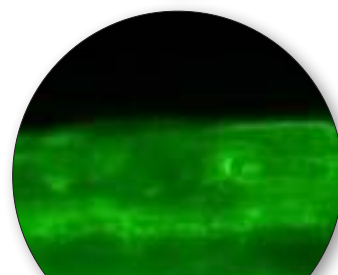

40x

Standard filterset

Name	Excitation filter (nm)	Dichroic mirror cut-off (nm)	Emission filter (nm)
B Blue	460 – 490	505	515LP

Part	Description
Observation mode:	Brightfield, LED fluorescence.
Epi-illumination and filter:	High-power blue LED with brightness control. 3-position filter holder; blue included.
Head:	Trinocular (fixed 50/50), 30° inclined, 360° rotating.
Interpupillary distance:	Adjustable between 48 and 75 mm.
Dioptric adjustment:	On the left eyepiece tube.
Eyepieces:	WF10x/20 mm, high eye-point and secured by screw.
Nosepiece:	Quintuple revolving nosepiece, rotation on ball bearings.
Objectives:	4x/0.10, W.D. 16.8 mm 10x/0.25, W.D. 5.8 mm 20x/0.40, W.D. 5.1 mm 40x/0.65, W.D. 0.43 mm 100x/1.25 (Oil/Water), W.D. 0.13 mm All with anti-fungus treatment.

Part	Description
Specimen stage:	Double layer rackless mechanical stage, 233x147 mm, 78x54 mm X-Y range.
Focusing:	Coaxial coarse (adjustable tension) and fine focusing mechanism with limit stop to prevent the contact between objective and specimen.
Condenser:	Abbe N.A. 1.25, with objective-coded iris diaphragm, focusable and centerable.
Transmitted illumination (Fixed Koehler type):	X-LED ³ with white 3.6 W LED (6,300K) with brightness control. Multi-plug 100-240Vac/6Vdc external power supply.

B-383POL - Polarizing Microscope

Upright microscope for brightfield and polarizing light observations with strain-free IOS N-PLAN POL objectives. Complete of polarizer and analyzer filters, Bertrand lens for conoscopic observation, compensator plates and high-precision rotatable stages. It comes with the exclusive **X-LED³** illumination system to deliver bright and clear images, along with all the accessories to perform accurate polarization analysis in biology and materials science.

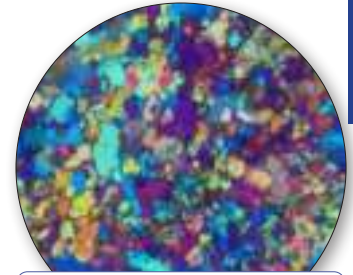

4x with First Order plate

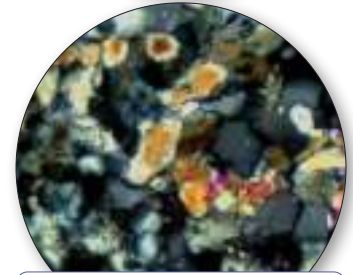

10x

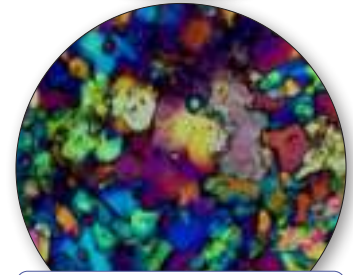

10x with First Order plate

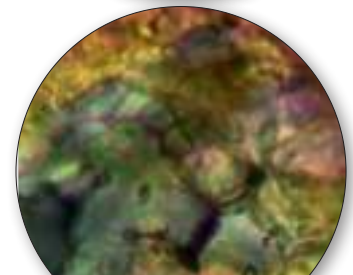

60x

Part	Description
Observation mode:	Brightfield, transmitted polarized light and conoscopy.
Bertrand lens and polarizing attachment:	Swing-out type with centering mechanism for observation in conoscopy/orthoscopy. Rotatable analyzer from 0° to 90° with graduated scale. Tint plates: 1° order red (λ); $\lambda/4$; Quartz wedge.
Head:	Trinocular (fixed 50/50), 30° inclined, 360° rotating.
Interpupillary distance:	Adjustable between 48 and 75 mm.
Dioptric adjustment:	On the left eyepiece tube.
Eyepieces:	WF10x/20 mm, high eye-point and secured by screw. One with crosshair.
Nosepiece:	Quadruple revolving nosepiece, rotation on ball bearings. Centering system for each objective.

Part	Description
Objectives (strain-free):	IOS N-PLAN POL 4x/0.10 IOS N-PLAN POL 10x/0.25 IOS N-PLAN POL 40x/0.65 IOS N-PLAN POL 60x/0.80 All with anti-fungus treatment.
Specimen stage:	Rotatable stage with locking mechanism. Vernier scale with accuracy 0.1 mm. Diameter 160 mm. Specimen slide clamps.
Focusing:	Coaxial coarse (adjustable tension) and fine focusing mechanism with limit stop to prevent the contact between objective and specimen.
Condenser:	Abbe N.A. 1.25, with objective-coded iris diaphragm, focusable and centerable. With rotating polarizing filter.
Transmitted illumination (Fixed Koehler type):	X-LED ³ with white 3.6 W LED (6.300 K) with brightness control. Multi-plug 100-240Vac/6Vdc external power supply.

B-383MET - Metallurgical Microscope

Brightfield upright microscope with IOS W-PLAN MET objectives and metallurgical attachment combining the exclusive **X-LED³** lighting source both for incident and transmitted illumination. The NCG (no cover glass) objectives are especially designed for microscopy use without a cover slip ideal for metallographic samples and other opaque specimens.

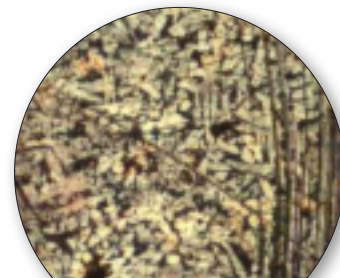

5x

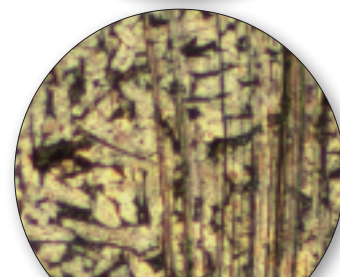

10x

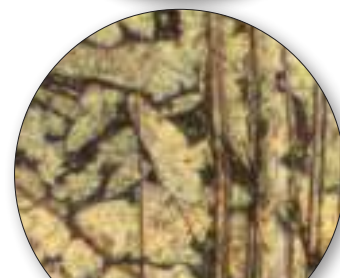

20x

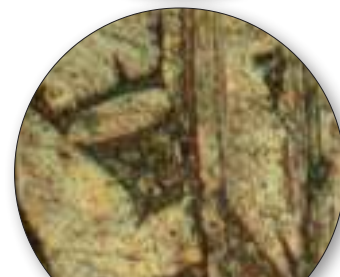

50x

Part	Description
Observation mode:	Brightfield, incident polarized light.
Epi-illumination and polarizing filters:	X-LED ³ with white 3.6 W LED (6.300 K) with brightness control. Field and aperture diaphragms, polarizer & analyzer filters.
Head:	Trinocular (fixed 50/50), 30° inclined, 360° rotating.
Interpupillary distance:	Adjustable between 48 and 75 mm.
Dioptric adjustment:	On the left eyepiece tube.
Eyepieces:	WF10x/20 mm, high eye-point and secured by screw.
Nosepiece:	Quintuple revolving nosepiece, rotation on ball bearings.

Part	Description
Objectives (strain-free):	IOS W-PLAN MET 5x/0.12 IOS W-PLAN MET 10x/0.25 IOS W-PLAN MET 20x/0.40 IOS W-PLAN MET 50x/0.75 All with anti-fungus treatment.
Specimen stage:	Double layer rackless mechanical stage, 233x147 mm, 78x54 mm X-Y range. With tempered glass plate.
Focusing:	Coaxial coarse (adjustable tension) and fine focusing mechanism with limit stop to prevent the contact between objective and specimen.
Condenser:	Abbe N.A. 1.25, with objective-coded iris diaphragm, focusable and centerable.
Transmitted illumination (Fixed Koehler type):	X-LED ³ with white 3.6 W LED (6.300 K) with brightness control. Multi-plug 100-240Vac/6Vdc external power supply.

B-380 Series - Comparison chart

Model	Head	Eyepieces	Nosepiece	Objectives	Stage	Focusing	Condenser	illumination
B-382PL-ALC	Binocular, 30° inclined	WF 10x/20	Quintuple, reversed	N-PLAN 4x, 10x, 40x, 100x (oil/water)	Rackless double layer, 150x139mm, moving range 75x33mm	Coaxial coarse and fine, limit stop, adjustable tension	Abbe N.A. 1.25, iris diaphragm, focusable and centrabale	3.6 W X-LED ³ , brightness control, ALC control. Fixed Koehler
B-383PL	Trinocular, 30° inclined, 360° rotating	WF 10x/20	Quintuple, reversed	N-PLAN 4x, 10x, 40x, 100x (oil/water)	Rackless double layer, 150x139mm, moving range 75x33mm	Coaxial coarse and fine, limit stop, adjustable tension	Abbe N.A. 1.25, iris diaphragm, focusable and centrabale	3.6 W X-LED ³ , brightness control. Fixed Koehler
B-382PLi-ALC	Binocular, 30° inclined	WF 10x/20	Quintuple, reversed	IOS N-PLAN 4x, 10x, 40x, 100x (oil/water)	Rackless double layer, 233x147mm, moving range 78x54 mm	Coaxial coarse and fine, limit stop, adjustable tension	Abbe N.A. 1.25, iris diaphragm, focusable and centrabale	3.6 W X-LED ³ , brightness control, ALC control. Fixed Koehler
B-383PLi	Trinocular, 30° inclined, 360° rotating	WF 10x/20	Quintuple, reversed	IOS N-PLAN 4x, 10x, 40x, 100x (oil/water)	Rackless double layer, 233x147mm, moving range 78x54 mm	Coaxial coarse and fine, limit stop, adjustable tension	Abbe N.A. 1.25, iris diaphragm, focusable and centrabale	3.6 W X-LED ³ , brightness control. Fixed Koehler
B-382PH-ALC	Binocular, 30° inclined	WF 10x/20	Quintuple, reversed	W-PLAN 4x, 10xPH, 40xPH, 100xPH (oil)	Rackless double layer, 150x139mm, moving range 75x33mm	Coaxial coarse and fine, limit stop, adjustable tension	Phase condenser (10x/20x, 40x, 100x) with darkfield (dry) and brightfield	3.6 W X-LED ³ , brightness control, ALC control. Fixed Koehler
B-383PH	Trinocular, 30° inclined, 360° rotating	WF 10x/20	Quintuple, reversed	W-PLAN 4x, 10xPH, 40xPH, 100xPH (oil)	Rackless double layer, 150x139mm, moving range 75x33mm	Coaxial coarse and fine, limit stop, adjustable tension	Phase condenser (10x/20x, 40x, 100x) with darkfield (dry) and brightfield	3.6 W X-LED ³ , brightness control. Fixed Koehler
B-382PHi-ALC	Binocular, 30° inclined	WF 10x/20	Quintuple, reversed	IOS W-PLAN 10xPH, 20xPH, 40xPH, 100xPH (oil)	Rackless double layer, 233x147mm, moving range 78x54 mm	Coaxial coarse and fine, limit stop, adjustable tension	Phase condenser (10x/20x, 40x, 100x) with darkfield (dry) and brightfield	3.6 W X-LED ³ , brightness control, ALC control. Fixed Koehler
B-383PHi	Trinocular, 30° inclined, 360° rotating	WF 10x/20	Quintuple, reversed	IOS W-PLAN 10xPH, 20xPH, 40xPH, 100xPH (oil)	Rackless double layer, 233x147mm, moving range 78x54 mm	Coaxial coarse and fine, limit stop, adjustable tension	Phase condenser (10x/20x, 40x, 100x) with darkfield (dry) and brightfield	3.6 W X-LED ³ , brightness control. Fixed Koehler
B-383DK	Trinocular, 30° inclined, 360° rotating	WF 10x/20	Quintuple, reversed	N-PLAN 4x, 10x, 40x, W-PLAN 100x (oil, with iris diaphragm)	Rackless double layer, 150x139mm, moving range 75x33mm	Coaxial coarse and fine, limit stop, adjustable tension	Abbe N.A. 1.25, iris diaphragm, focusable and centrabale. Additional darkfield condenser, N.A. 1.36, built-in X-LED ³	3.6 W X-LED ³ , brightness control. Fixed Koehler
B-383FL	Trinocular, 30° inclined, 360° rotating	WF 10x/20	Quintuple, reversed	IOS N-PLAN 4x, 10x, 20x, 40x, 100x (oil/water)	Rackless double layer, 233x147mm, moving range 78x54 mm	Coaxial coarse and fine, limit stop, adjustable tension	Abbe N.A. 1.25, iris diaphragm, focusable and centrabale	Transmitted: 3.6 W X-LED ³ , brightness control. Fixed Koehler Incident: HBO 100 W high-pressure mercury bulb
B-383LD	Trinocular, 30° inclined, 360° rotating	WF 10x/20	Quintuple, reversed	IOS N-PLAN 4x, 10x, 20x, 40x, 100x (oil/water)	Rackless double layer, 233x147mm, moving range 78x54 mm	Coaxial coarse and fine, limit stop, adjustable tension	Abbe N.A. 1.25, iris diaphragm, focusable and centrabale	Transmitted: 3.6 W X-LED ³ , brightness control. Fixed Koehler Incident: High-power blue LED
B-383POL	Trinocular, 30° inclined, 360° rotating	WF 10x/20 (one with crosshair reticle)	Quadruple, reversed	Strain-free IOS N-PLAN POL 4x, 10x, 40x, 60x	Round, 360° rotating, 160mm diameter, with sample clips and stop knob	Coaxial coarse and fine, limit stop, adjustable tension	Abbe N.A. 1.25, iris diaphragm, focusable and centrabale. With rotating polarizer	3.6 W X-LED ³ , brightness control. Fixed Koehler
B-383MET	Trinocular, 30° inclined, 360° rotating	WF 10x/20	Quintuple, reversed	IOS W-PLAN MET 5x, 10x, 20x, 50x	Rackless double layer, 233x147mm, moving range 78x54 mm	Coaxial coarse and fine, limit stop, adjustable tension	Abbe N.A. 1.25, iris diaphragm, focusable and centrabale	Transmitted and incident: 3.6 W X-LED ³ , brightness control. Fixed Koehler

② B-380 Series - Accessories

Eyecups & Eyepieces

- M-001 Huygens 5x eyepiece
- M-008.1 WF10x/20 eyepiece, high eyepoint, with pointer, rubber cup
- M-160 EW10x/20 eyepiece, high eyepoint, with rubber cup
- M-161 EW15x/16 eyepiece, with rubber cup
- M-162 WF20x/10 eyepiece
- M-163 EW10x/20 micrometric eyepiece, high eyepoint, with rubber cup

Objectives

N-PLAN

- M-164 N-PLAN objective 4x/0.10
- M-165 N-PLAN objective 10x/0.25
- M-166 N-PLAN objective 20x/0.40
- M-167 N-PLAN objective 40x/0.65
- M-168 N-PLAN objective 60x/0.85
- M-169 N-PLAN objective 100x/1.25 (oil)

IOS N-PLAN

- M-144 IOS N-PLAN objective 4x/0.10
- M-145 IOS N-PLAN objective 10x/0.25
- M-146 IOS N-PLAN objective 20x/0.40
- M-147 IOS N-PLAN objective 40x/0.65
- M-149 IOS N-PLAN objective 60x/0.80
- M-148 IOS N-PLAN objective 100x/1.25 (oil)
- M-144P IOS N-PLAN POL objective 4x/0.10
- M-145P IOS N-PLAN POL objective 10x/0.25
- M-146P IOS N-PLAN POL objective 20x/0.40
- M-147P IOS N-PLAN POL objective 40x/0.65
- M-149P IOS N-PLAN POL objective 60x/0.80
- M-148P IOS N-PLAN POL objective 100x/1.25 (oil)

W-PLAN

- M-059 W-PLAN objective 100x/1.25OI - (oil) objective with iris for DF
- M-170 W-PLAN PH objective 10x/0.25
- M-171 W-PLAN PH objective 20x/0.40
- M-172 W-PLAN PH objective 40x/0.65
- M-182 W-PLAN PH objective 100x/1.25 (oil)

IOS W-PLAN

- M-634.1 IOS W-PLAN objective 50x/0.95 (oil)
- M-336 IOS W-PLAN MET objective 5x/0.12
- M-338 IOS W-PLAN MET objective 10x/0.25
- M-339 IOS W-PLAN MET objective 20x/0.40
- M-335 IOS W-PLAN MET objective 50x/0.75
- M-698.2 IOS W-PLAN MET objective 100x/0.80 (dry)
- M-1120.N IOS W-PLAN PH objective 10x/0.25
- M-1121.N IOS W-PLAN PH objective 20x/0.40
- M-1122.N IOS W-PLAN PH objective 40x/0.65
- M-1123.N IOS W-PLAN PH objective 100x/1.25 (oil)



M-181 - PH set - 10x, 20x, 40x, 100x IOS W-PLAN PH obj. & BF/DF/PH condenser



M-185 - Darkfield condenser for dry objectives



M-179 - PH set - 10x, 40x, 100x W-PLAN PH obj. & BF/DF/PH condenser

B-380 Series - Accessories

Stages

M-175	Rotating stage for polarising set (for 150x139mm rackless stage) (except for B-382PH-ALC, B-383PH and B-383DK)
M-175.1	Rotating stage for polarising set (for 233x147mm rackless stage) (except for B-382PHi-ALC and B-383PHi)
M-635	Heating stage (on newly purchased microscopes, for 233x147mm stage), multiplug
M-666.290	Heating stage (on newly purchased microscopes, for 150x139mm stage), multiplug

Condensers & Filters

M-174.1	Polarising set (filters only) (except for B-383POL)
M-179	PH set - 10x, 40x, 100x W-PLAN PH obj. & BF/DF/PH condenser
M-181	PH set - 10x, 20x, 40x, 100x IOS W-PLAN PH obj. & BF/DF/PH condenser
M-185	Darkfield condenser for dry objectives
M-975.1	Ring with blue filter, 45mm diameter
M-977.1	Ring with green filter, 45mm diameter
M-979.1	Ring with yellow filter, 45mm diameter
M-989.1	Ring with frosted glass filter, 45mm diameter

Camera Adapters

M-115	0.35x C-Mount projection lens
M-114	0.5x C-Mount projection lens
M-118	0.75x C-Mount projection lens
M-173	C-Mount projection lens for APS-C/full frame reflex cameras (trino)
M-620	0.35x focusable C-Mount adapter (biological microscopes)
M-620.1	0.5x focusable C-Mount adapter (biological microscopes)
M-620.2	0.65x focusable C-Mount adapter (biological microscopes)
M-620.3	1x focusable C-Mount adapter (biological & stereomicroscopes)
M-699	Universal adapter for C-Mount projection lens (trino)

Miscellaneous

15008	Immersion oil, 10ml
15009	Immersion oil, 100ml
15104	Cleaning kit
DC-002	Plastic dust cover, medium, 490(l)x490(h) mm (except for B-383POL, B-383MET, B-383LD1, B-383LD2 and B-383FL)
DC-003	TNT dust cover, medium, 600(l)x550(h) mm (only for B-383POL, B-383MET, B-383LD1, B-383LD2 and B-383FL)
M-005	Micrometric slide, 26x76mm, with 2 scales (1mm/100 & 10mm/100)
M-069	Solar charger
M-151	HBO 100W high-pressure mercury bulb for fluorescence (only for B-383FL)
M-151.1	HBO 100W high-pressure mercury bulb for fluorescence (OSRAM) (only for B-383FL)
M-156	Koehler field diaphragm (on newly purchased microscopes) (except for B-383POL)
M-1380	Centering telescope, 23mm diameter
VP-380	IQ/OQ/PQ manual for B-380 series
AB-020	Antibacterial surface treatment, only for newly purchased microscope



How to connect the cameras to our microscopes.

Please refer to the Adapter reference list on Digital section.

15104 - Cleaning kit

It cleans glass quickly and effectively, without leaving residue or odor. Ideal for precision lens or prism cleaning.



M-069 - Solar charger

Included battery: rechargeable – Lithium-Poly.
Capacity: 2500 mAh. - Output voltage: 5 Vdc.
Autonomy: over 6 hours at medium intensity (X-LED³).
Charging models: with solar panel (12h), with external USB power supply (2.5h)

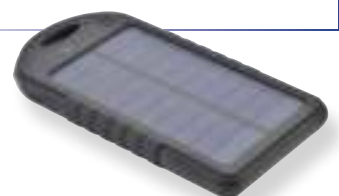

v 7.5 - OPTIKA reserves the right to make corrections, modifications, enhancements, improvements and other changes to its products at any time without notice.

Headquarters and Manufacturing Facilities

OPTIKA® S.r.l. Via Rigla, 30 - 24010 Ponteranica (BG) - ITALY - Tel.: +39 035.571.392 - info@optikamicroscopes.com

Optika Sales branches

OPTIKA® Spain spain@optikamicroscopes.com
OPTIKA® China china@optikamicroscopes.com
OPTIKA® India india@optikamicroscopes.com

OPTIKA® North America namerica@optikamicroscopes.com
OPTIKA® Central America camerica@optikamicroscopes.com
OPTIKA® Africa africa@optikamicroscopes.com

OPTIKA[®]
M I C R O S C O P E S
I T A L Y

B-510 Series



Advanced Routine Lab Upright Microscopes

Born To Be Professional

HIGH-GRADE CONFIGURATIONS FOR PROFESSIONALS

- » Wide range to fulfill specific lab requirements
- » Valuable solutions for life and material sciences
- » Compliant with several observation methods

AN AFFORDABLE PARTNER WITH HIGH-END FEATURES

- » IOS W-PLAN objectives for flat images on 22 mm FN
- » Full Koehler illumination for enhanced images
- » Rounded edge, rackless stage to prevent scratches



Optically Impressive

MAINTAINING GOOD EYESIGHT

- » 10x/22 eyepieces for large specimen view
- » Comfortable rubber cup to get rid of annoying external light
- » High eye-point for glasses wearers, dioptic adjustment (left eyepiece)

B-510 & IOS W-PLAN: THE PERFECT COMBINATION

- » IOS Infinity corrected optical system
- » Full planarity optics on 22 mm (W-PLAN) according to ISO 19012-1
- » High-grade Semi-Apo lens available ideal for fluorescence



An Extensive Range of Different Configurations

THE MODELS FOR ASBESTOS TESTING IN ENVIRONMENTAL MONITORING

- » B-510ASB measures fiber concentrations in air and includes 40xPH lens and 12.5x Walton & Beckett eyepieces
- » B-510POL & B-510POL-I for bulk/fiber class identification

B-510DK - THE DEDICATED MODEL FOR FRESH BLOOD ANALYSIS

- » Exclusive X-LED³ darkfield cardioid condenser with high N.A. 1.36 and the new IOS W-PLAN 100x oil iris objective
- » Brightfield condenser also supplied

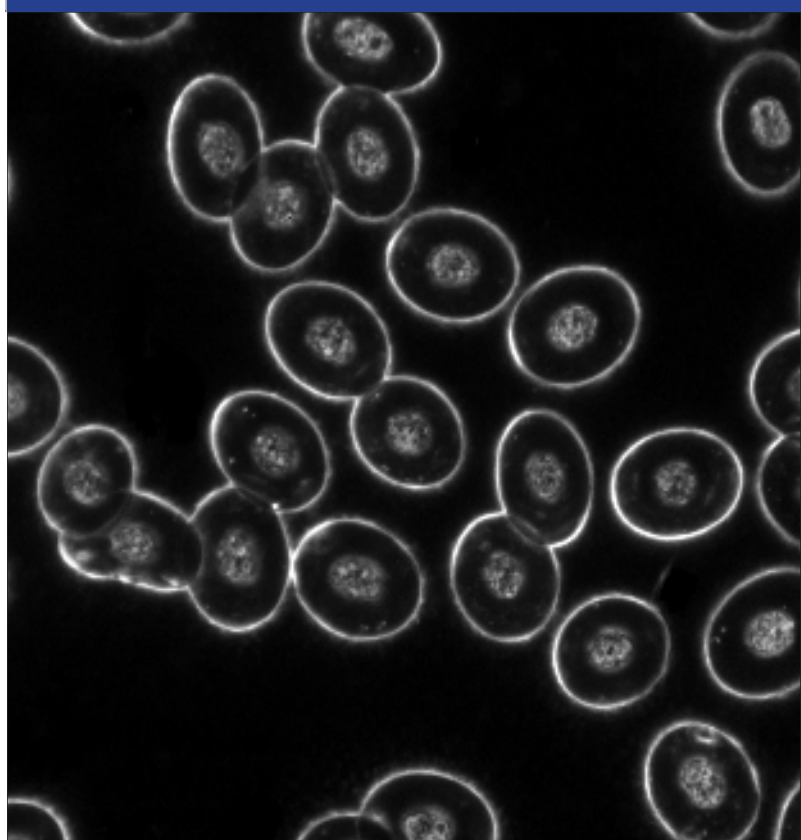
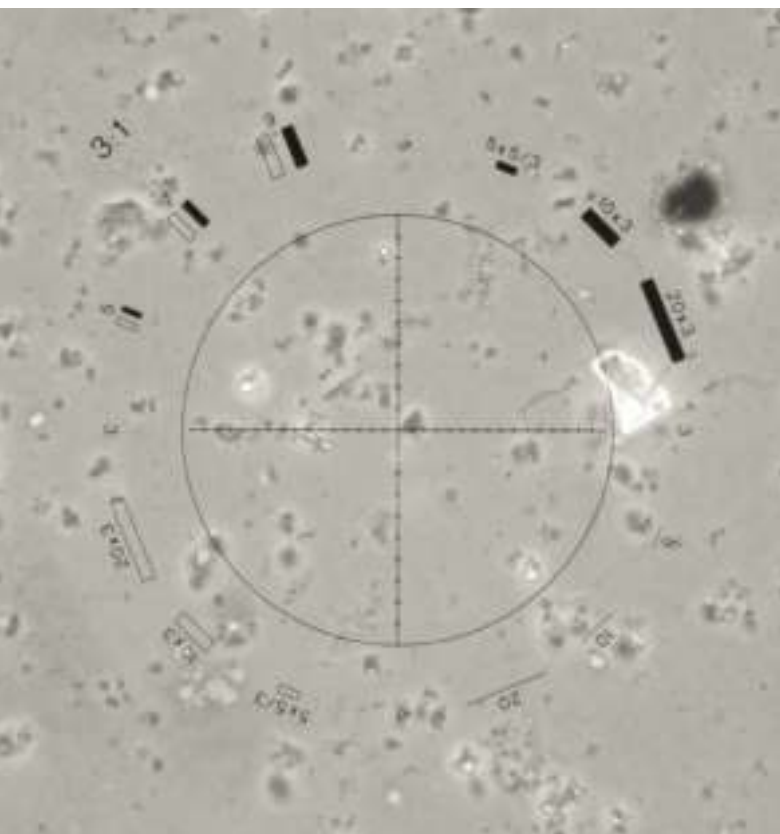

Multiple Observation Methods

BRIGHTFIELD

METALLOGRAPHY

DARKFIELD

POLARIZATION

FLUORESCENCE

PHASE CONTRAST

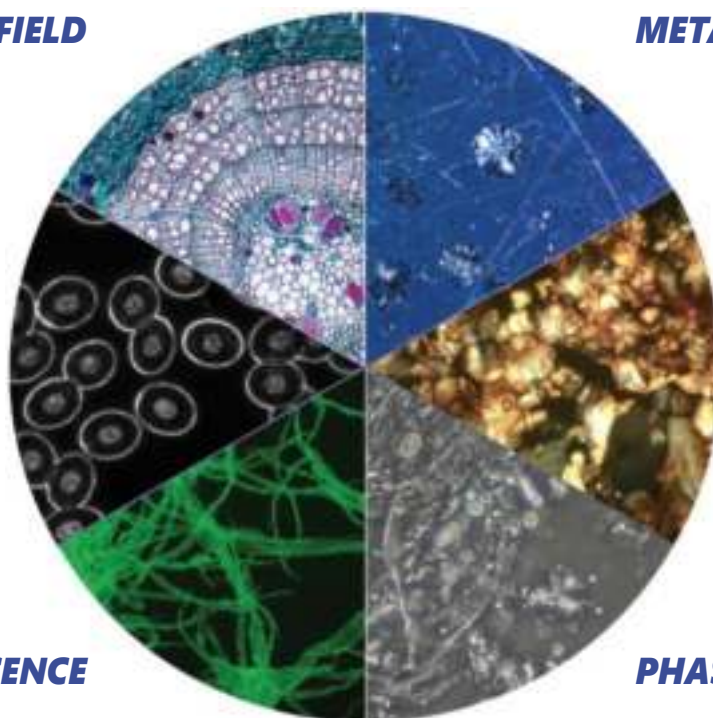

Many Specimens, Many Observers - Intense Productivity

2

INCREASE YOUR SAMPLE THROUGHPUT

- » Large, resistant stage to easily and quickly process 2 samples
- » Ergonomic design and controls for extended operation
- » Convenient handle for easy transportation

DISCUSSION BRIDGES FOR SIMULTANEOUS OBSERVATIONS AND TEACHING

- » RGB pointer with brightness adjustment for the main observer
- » Face-to-face attachment with 1 extra viewing head, 20mm FN
- » Side attachment with 1, 2 & 4 extra viewing heads, 20mm FN

Laboratory



Multi-Head Discussion Microscopes

With discussion bridges, up to 5 people/colleagues can observe the same image on B-510. Ideal for teaching and training students, especially in the medical field. The main observer and additional viewers will benefit of an extremely homogeneous light conditions, with a three-colour pointer with settable intensity to highlight points of interest.

X-LED³ - Only Available at OPTIKA

STATE-OF-THE-ART ILLUMINATION SYSTEM

- » Uncomparable light intensity, exclusive lens & collector design
- » Constant pure-white color temperature at all intensity levels
- » Unmatched color fidelity, uniformity and brightness

CUT ELECTRICITY BILLS BY 90%

- » Money & energy saving, only 3.6 W
- » More efficient brightness than a 50 W halogen lamp
- » LED long lifetime (65,000 hours = 22 years at 8 hours/day usage)

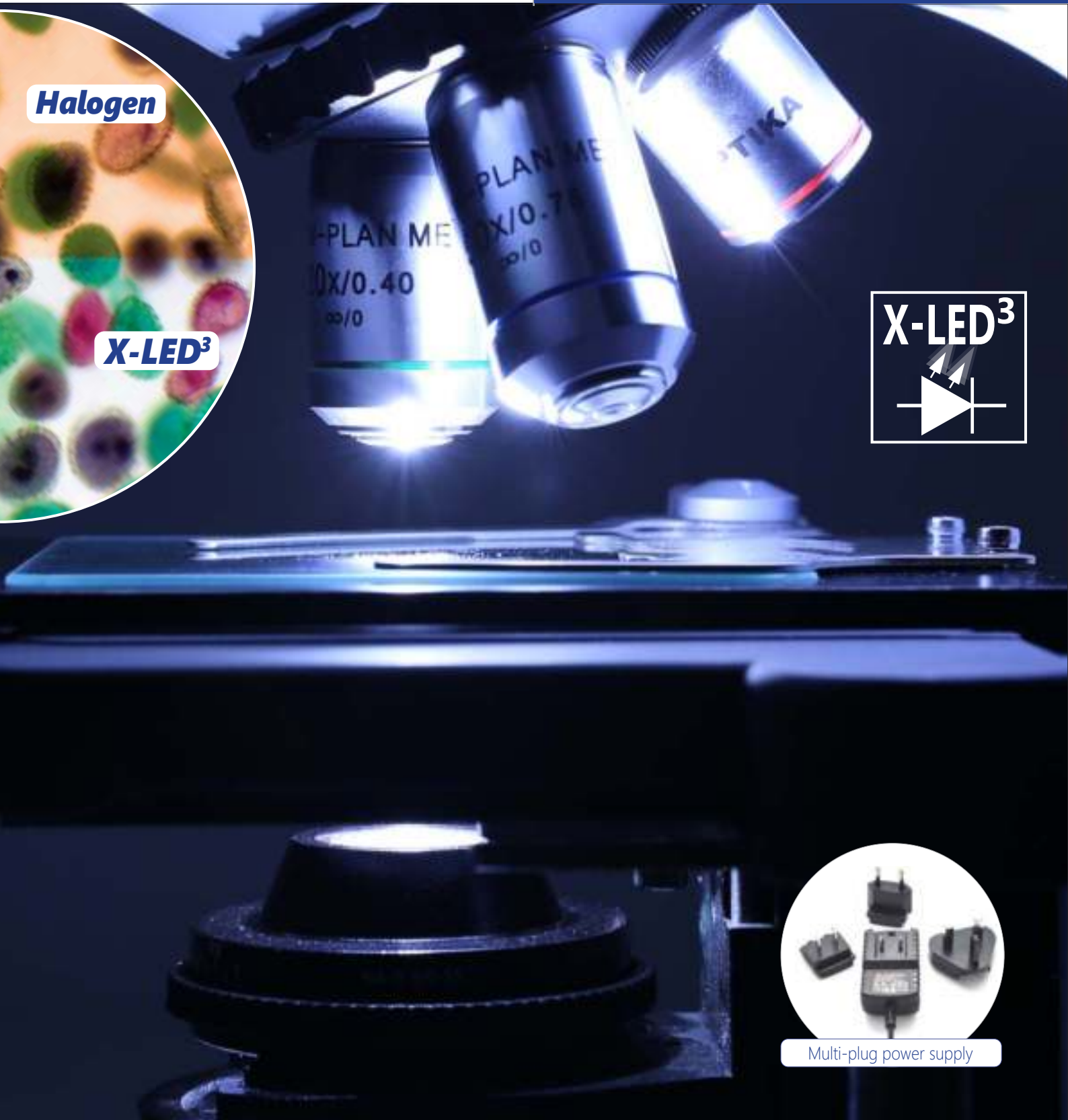

Halogen

X-LED³

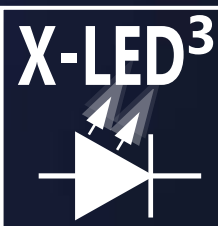

Multi-plug power supply

Go Digital - Vivid Colors & Contrast For Stunning Images

2

STAY CONNECTED WITH YOUR SPECIMEN, EASILY

- » Trinocular port to be always updated with the latest technology cameras, even in the future
- » Wide range of cameras matching all the needs, including the more specific ones
- » Modern C-mount focusable professional adapters for all kinds of cameras

PROFESSIONAL IMAGE ANALYSIS

- » Multi-language software for live-view, picture and video in different file formats
- » Advanced functions for pictures processing (EDF, stitching, multi-fluorescence combine)
- » Powerful tools to perform measurements and generate custom reports

Laboratory



B-510 Series

OPTIKA B-510 Series meets a wide variety of analysis applications, thanks to the comprehensive range of microscope models equipped with enhanced and impressive optics, a wide field of view of 22 mm, the state-of-the-art, exclusive X-LED lighting source and Koehler illuminator to produce high sample contrast and homogeneous bright light.

A Perfect Downgrading of Top-Level Series

Many components of B-510 come from the B-810/1000 Series, the top-level in OPTIKA range, to ensure the state-of-the-art performance and at the same time an incredible level of reliability and durability. Its excellent quality/price ratio is achieved through an intelligent rationalization of production costs and choice of materials.

X-LED³ Exclusive Lighting Source

Special technology able to double the light intensity for incomparable performance, ensuring constant pure-white colour temperature (6,300K colour temperature).

Relevant money and energy saving thanks to the incredibly low energy consumptions which allows you to cut the electricity bills by 90%!

The electric consumption (3.6 W only) proves the high efficiency of this system: incredibly high light intensity combined with low consumption.

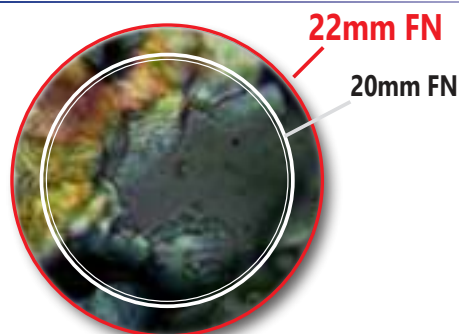

Large Specimen View (22 mm Field Number)

The **F.O.V.** (field of view) is based on a comfortable diameter of 22 mm.

This means that an extra wide area of the sample can be inspected and allows a natural and easy view, particularly needed in a laboratory environment.

Safe And Convenient Operations

Rounded edge rackless stage has been designed with a belt-driven mechanism that allows a smooth movement without any protruding part.

This design gives you a more compact solution and lowers any risk of injury after accidentally hitting the rack with your hands.

The electric consumption (3.6 W only) proves the high efficiency of this system: incredibly high light intensity combined with low consumption.



OPTIKA
LABORATORY

Advanced Routine Lab Upright Microscopes

Universal Condenser For Brightfield, Darkfield & Phase

OPTIKA B-510 phase contrast microscopes are equipped with a 5-position dedicated rotating condenser for brightfield (standard use), phase contrast (10x/20x, 40x and 100x phase diaphragms), and a darkfield position for dry objectives.



Exclusive X-LED³ Darkfield Condenser

The special condenser with integrated, exclusive X-LED³ illuminator replaces any other external and expensive lighting source required for these applications and is ideal for great-looking, rich and high-quality specimen view.

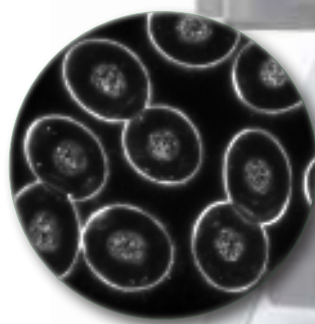

In fluorescence we can offer several options.

According to your application and to the fluorochromes you are using, we can help you to identify the best light source.

Traditional, HBO Fluorescence

- » The most used and diffused method, worldwide
- » Wide spectrum range for future upgrades

Innovative, LED Fluorescence

- » Recommended for routine applications
- » Cost-effective, money saving technology
 - » Ready for immediate operation
 - » Eliminate warm-up/cool-down times
 - » Forget lamp replacement & centering



B-510BF / B-510ERGO - Brightfield Microscope

Advanced routine laboratory microscope for brightfield observations with IOS W-PLAN objectives and rackless stage. The high-efficiency **X-LED³** makes it reliable for all transmitted light observations for great-looking, rich and high-quality view.



B-510BF



B-510ERGO

Part	Description
Observation mode:	Brightfield.
Head:	B-510BF: Trinocular (fixed 50/50), 30° inclined, 360° rotating. B-510ERGO: Binocular ergonomical head, 30° - 60° inclined, 360° rotating.
Interpupillary distance:	Adjustable between 50 and 75 mm.
Dioptric adjustment:	On the left eyepiece tube.
Eyepieces:	WF10x/22 mm, high eye-point and with rubber cups.
Nosepiece:	Quintuple revolving nosepiece, rotation on ball bearings.
Objectives:	IOS W-PLAN 4x/0.10 IOS W-PLAN 10x/0.25 IOS W-PLAN 40x/0.65 IOS W-PLAN 100x/1.25 (Oil) All with anti-fungus treatment.

Part	Description
Specimen stage:	Double layer rackless mechanical stage, 233x147 mm, 78x54 mm X-Y range.
Focusing:	Coaxial coarse (adjustable tension) and fine focusing mechanism with limit stop to prevent the contact between objective and specimen.
Condenser:	Swing-out N.A. 0.2/0.9, with iris diaphragm, focusable and centerable.
Transmitted illumination (Full Koehler type):	X-LED ³ with white 3.6 W LED (6,300K) with brightness control. Multi-plug 100-240Vac/6Vdc external power supply.

B-510PH - Phase Contrast Microscope

Advanced routine laboratory microscope for brightfield, darkfield and phase contrast observations with IOS W-PLAN PH objectives and rackless stage. Especially dedicated to phase contrast observation, the microscope ensures a high image sharpness even with complex specimens. The high-efficiency **X-LED³** makes it reliable for all transmitted light observations.



Part	Description
Observation mode:	Brightfield, phase contrast and darkfield (dry).
Head:	Trinocular (fixed 50/50), 30° inclined, 360° rotating.
Interpupillary distance:	Adjustable between 50 and 75 mm.
Dioptric adjustment:	On the left eyepiece tube.
Eyepieces:	WF10x/22 mm, high eye-point and with rubber cups.
Nosepiece:	Quintuple revolving nosepiece, rotation on ball bearings.
Objectives:	IOS W-PLAN PH 10x/0.25 IOS W-PLAN PH 20x/0.40 IOS W-PLAN PH 40x/0.65 IOS W-PLAN PH 100x/1.25 (Oil) All with anti-fungus treatment.

Part	Description
Specimen stage:	Double layer rackless mechanical stage, 233x147 mm, 78x54 mm X-Y range.
Focusing:	Coaxial coarse (adjustable tension) and fine focusing mechanism with limit stop to prevent the contact between objective and specimen.
Condenser:	Phase condenser (10x/20x, 40x, 100x) with darkfield (dry) and brightfield.
Transmitted illumination (Full Koehler type):	X-LED ³ with white 3.6 W LED (6,300K) with brightness control. Multi-plug 100-240Vac/6Vdc external power supply.

B-510ASB - Asbestos Analysis Microscope

Advanced routine laboratory microscope for brightfield and phase contrast observations with IOS W-PLAN objectives and rackless stage. Ideal for Asbestos analysis in accordance to international rules with 12.5x eyepieces and Walton & Becket graticule to perform perfect asbestos fibers analysis at a glance. The high-efficiency **X-LED³** makes it reliable for all transmitted light observations.



Part	Description
Observation mode:	Brightfield, phase contrast.
Head:	Trinocular (fixed 50/50), 30° inclined, 360° rotating.
Interpupillary distance:	Adjustable between 50 and 75 mm.
Dioptric adjustment:	On the left eyepiece tube.
Eyepieces:	WF10x/22 mm, high eye-point and WF12.5x/15 mm with dioptric adjustment, one with Walton & Beckett graticule.
Nosepiece:	Quintuple revolving nosepiece, rotation on ball bearings.
Objectives:	IOS W-PLAN 4x/0.10 IOS W-PLAN 10x/0.25 IOS W-PLAN PH 40x/0.65 IOS W-PLAN 100x/1.25 (Oil) All with anti-fungus treatment.

Part	Description
Specimen stage:	Double layer rackless mechanical stage, 233x147 mm, 78x54 mm X-Y range.
Focusing:	Coaxial coarse (adjustable tension) and fine focusing mechanism with limit stop to prevent the contact between objective and specimen.
Condenser:	Abbe N.A. 1.25, with objective-coded iris diaphragm, focusable and centerable. With 40x phase contrast slider.
Transmitted illumination (Full Koehler type):	X-LED ³ with white 3.6 W LED (6,300K) with brightness control. Multi-plug 100-240Vac/6Vdc external power supply.

B-510DK - Immersion Darkfield Microscope

Advanced routine laboratory microscope for brightfield and darkfield observations with IOS W-PLAN objectives (including 100x with iris diaphragm) and rackless stage for biology and especially darkfield fresh blood analysis and the exclusive **X-LED³** illumination system. The special condenser with integrated, exclusive X-LED³ illuminator replaces any other external and expensive lighting source required for these applications and is ideal for great-looking, rich and high-quality specimen view. Our immersion darkfield system provides the same result achieved by 150W external illuminators in combination with traditional cardioid darkfield condenser.

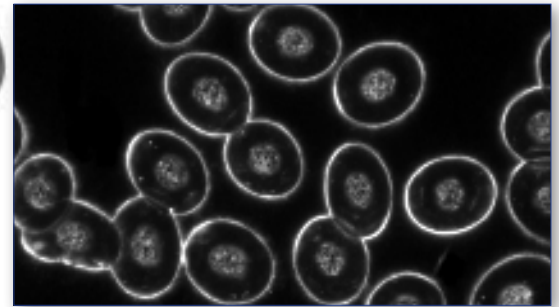

Part	Description
Observation mode:	Brightfield, oil immersion darkfield.
Head:	Trinocular (fixed 50/50), 30° inclined, 360° rotating.
Interpupillary distance:	Adjustable between 50 and 75 mm.
Dioptric adjustment:	On the left eyepiece tube.
Eyepieces:	WF10x/22 mm, high eye-point and with rubber cups.
Nosepiece:	Quintuple revolving nosepiece, rotation on ball bearings.
Objectives:	IOS W-PLAN 4x/0.10 IOS W-PLAN 10x/0.25 IOS W-PLAN 40x/0.65 IOS W-PLAN 100x/1.25 (oil) with iris All with anti-fungus treatment.

Part	Description
Specimen stage:	Double layer rackless mechanical stage, 233x147 mm, 78x54 mm X-Y range.
Focusing:	Coaxial coarse (adjustable tension) and fine focusing mechanism with limit stop to prevent the contact between objective and specimen.
Brightfield condenser:	Darkfield N.A. 1.36 (oil immersion) with built-in X-LED ³ .
Transmitted illumination (Full Koehler type):	X-LED ³ with white 3.6 W LED (6,300K) with brightness control. Multi-plug 100-240Vac/6Vdc external power supply.

2 B-510FL - HBO Fluorescence Microscope

Advanced routine laboratory microscope for brightfield and fluorescence observations with Semi-Apo IOS W-PLAN F objectives to enhance the visibility of the sample and increase the overall contrast. The **HBO fluorescence** illuminator provides an outstanding flexibility of use, standing the blue and green filter sets (supplied as standard) for Auramine, FITC, GFP and YFP (with blue filter set) plus Rhodamine, Texas Red and TRITC (with the green one), yet giving the possibility to combine any other specific filter sets for future upgrade. Transmitted light through the exclusive **X-LED³** to ensure great-looking, rich and high-quality specimen view.

-  22
- 
- 
- 
- 
- 
- 
- 

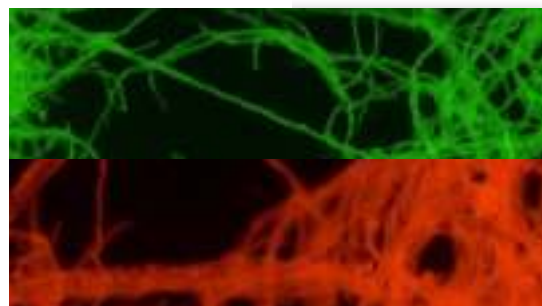

Standard filterset

Name	Excitation filter (nm)	Dichroic mirror cut-off (nm)	Emission filter (nm)
B Blue	460 - 490	505	515LP
G Green	510 - 550	570	575LP



Additional filterset (optional)

Name	Excitation filter (nm)	Dichroic mirror cut-off (nm)	Emission filter (nm)
V (Violet)	390 - 420	440	455LP
UV	325 - 375	415	435LP

Part	Description
Observation mode:	Brightfield, HBO fluorescence.
Epi-illumination and filter:	HBO 100 W high pressure mercury lamp. 4-position filter holder; blue & green included.
Head:	Trinocular (3-position 100/0, 50/50, 0/100), 30° inclined, 360° rotating.
Interpupillary distance:	Adjustable between 50 and 75 mm.
Dioptric adjustment:	On the left eyepiece tube.
Eyepieces:	WF10x/22 mm, high eye-point and with rubber cups.
Nosepiece:	Quintuple revolving nosepiece, rotation on ball bearings.
Objectives:	IOS W-PLAN F 4x/0.13 IOS W-PLAN F 10x/0.30 IOS W-PLAN F 20x/0.50 IOS W-PLAN F 40x/0.75 All with anti-fungus treatment.

Part	Description
Specimen stage:	Double layer rackless mechanical stage, 233x147 mm, 78x54 mm X-Y range.
Focusing:	Coaxial coarse (adjustable tension) and fine focusing mechanism with limit stop to prevent the contact between objective and specimen.
Condenser:	Swing-out N.A. 0.2/0.9, with iris diaphragm, focusable and centerable.
Transmitted illumination (Full Koehler type):	X-LED ³ with white 3.6 W LED (6,300K) with brightness control. Multi-plug 100-240Vac/6Vdc external power supply.

B-510LD4 - LED Fluorescence Microscope

Advanced routine fluorescence microscope for transmitted brightfield and fluorescence observations with IOS W-PLAN objectives. The extremely powerful LED Fluorescence Illuminators are combined with corresponding excitation filter sets for the visualization of most fluorochromes. LED fluorescence ensures unparalleled convenience eliminating warm-up/cool-down times and all the inconveniences related lamp replacement and adjustment. Transmitted light through the exclusive **X-LED³** to ensure great-looking, rich and high-quality specimen view.

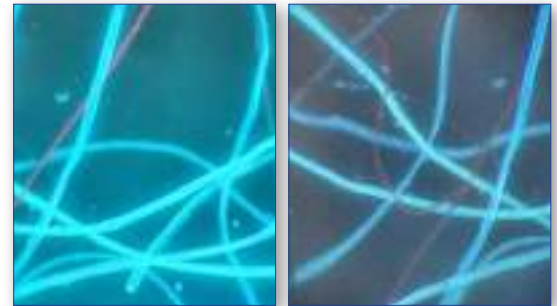
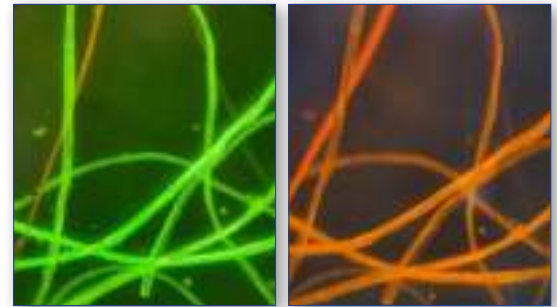

A new milestone achieved in Fluorescence Microscopy

- » Full-modular Fluorescence System
- » Interchangeable LED-Filtersets
- » 4 LED-Filtersets slots
- » 10% higher light intensity than HBO
- » 35% higher light intensity than Metal-Halide
- » Adjustable light intensity
- » The selection of filtersets automatically involves the switching on of the corresponding LEDs
- » Cost-effective, money saving technology
- » Ready for immediate operation
- » Eliminate warm-up/cool-down times
- » Forget lamp replacement & centering

Part	Description
Observation mode:	Brightfield, LED fluorescence.
Epi-illumination and filter:	High-power LED with brightness control. 4-position filter holder; none included.
Head:	Trinocular (3-position 100/0, 50/50, 0/100), 30° inclined, 360° rotating.
Interpupillary distance:	Adjustable between 50 and 75 mm.
Dioptric adjustment:	On the left eyepiece tube.
Eyepieces:	WF10x/22 mm, high eye-point and with rubber cups.
Nosepiece:	Quintuple revolving nosepiece, rotation on ball bearings.
Object.: B-510LD4:	IOS W-PLAN 4x/0.10 IOS W-PLAN 10x/0.25 IOS W-PLAN 40x/0.65 IOS W-PLAN 100x/1.25 (Oil)
B-510LD4-SA:	IOS W-PLAN F 4x/0.13 IOS W-PLAN F 10x/0.30 IOS W-PLAN F 40x/0.75 IOS W-PLAN F 100x/1.3 (Oil)
	All with anti-fungus treatment.

Part	Description
Specimen stage:	Double layer rackless mechanical stage, 233x147 mm, 78x54 mm X-Y range.
Focusing:	Coaxial coarse (adjustable tension) and fine focusing mechanism with limit stop to prevent the contact between objective and specimen.
Condenser:	Swing-out N.A. 0.2/0.9, with iris diaphragm, focusable and centerable.
Transmitted illumination (Full Koehler type):	X-LED ³ with white 3.6 W LED (6,300K) with brightness control. Multi-plug 100-240Vac/6Vdc external power supply.

B-510LD4 - LED Fluorescence Microscope



OPTIKA LED Fluorescence attachment is a revolutionary solution.

It consists of a 4-position selector for the use of 4 fluorescent illuminators, called LED Fluorescence Cubes.

Each Cube is composed of a filterset mounted on a filterblock and a high power LED with emission corresponding to the filters installed. In this way the selection of each filter controls the lighting up of the corresponding LED.

The microscope is supplied without any LED Fluorescence Cube. A selection of 9 types is available, as shown in the table below.

B-510LD4

Trinocular brightfield microscope, 1000x,
IOS W-PLAN objectives



B-510LD4-SA

Trinocular brightfield microscope, 1000x,
IOS W-PLAN F (Semi-Apo) objectives. **For UV Fluorescence**



M-1220 ... M-1228

LED Fluorescence Cubes (LED + Filterset)

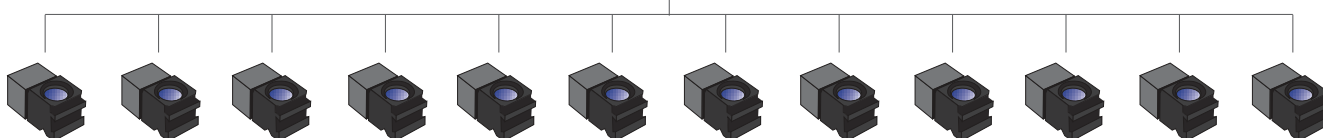

LED Fluorescence Cubes available (LED + Filterset)

Name	LED emission (nm)	Excitation filter (nm)	Dichroic mirror cut-off (nm)	Emission filter (nm)
M-1220 - Blue	460	455 - 495	500	510LP
M-1220.1 - Blue (pass band)	460	455 - 495	500	518-542
M-1221 - Green	523	510 - 550	570	575LP
M-1221.1 - Green (pass band)	523	510 - 550	570	585-625
M-1222 - Violet	405	390 - 420	440	450LP
M-1223 - UV	365	325 - 375	415	435LP
M-1223.1 - UV (pass band)	365	340 - 390	405	420-470
M-1224 - Red 1 *	623	590 - 650	660	665LP
M-1225 - Red 2 *	623	595 - 645	655	665 - 715
M-1226 - Deep Red *	660	623 - 678	685	690 - 750
M-1227 - Far Red *	740	720 - 760	770	780LP
M-1228 - Amber	590	582 - 603	610	615 - 645

* If the use of a camera is needed, when used for red emission fluorescence wavelengths above 650nm, please order OPTIKA camera code C-P6AR.

B-510POL - Polarizing Microscope

Advanced routine laboratory microscope for transmitted light in brightfield and polarized light observations with strain-free IOS W-PLAN POL objectives. Complete of polarizer and analyzer filters, Bertrand lens for conoscopic observation, compensator plates and high-precision rotatable stages. It comes with the exclusive **X-LED³** illumination system to deliver bright and clear images, along with all the accessories to perform accurate polarization analysis in biology and materials science.

-  22
- 
-  X-LED³
- 
-  IOS
-  W-PLAN
-  POL
- 

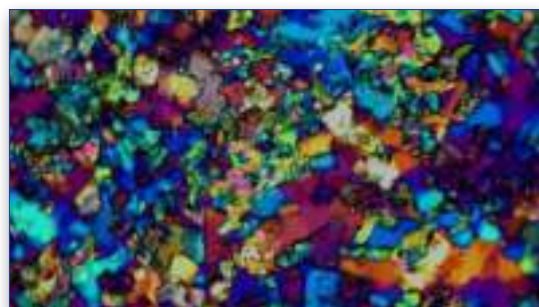

Part	Description
Observation mode:	Brightfield, transmitted polarized light and conoscopy.
Bertrand lens and polarizing attachment:	Swing-out type with centering mechanism for observation in conoscopy/orthoscopy. Rotatable analyzer from 0° to 90° with graduated scale. Tint plates: 1° order red (λ); $\lambda/4$; Quartz wedge.
Head:	Trinocular (fixed 50/50), 30° inclined, 360° rotating.
Interpupillary distance:	Adjustable between 50 and 75 mm.
Dioptric adjustment:	On the left eyepiece tube.
Eyepieces:	WF10x/22 mm, high eye-point and with rubber cups. One with crosshair.
Nosepiece:	Quadruple revolving nosepiece, rotation on ball bearings. Centering system for each objective.

Part	Description
Objectives (strain-free):	IOS W-PLAN POL 4x/0.10 IOS W-PLAN POL 10x/0.25 IOS W-PLAN POL 20x/0.45 IOS W-PLAN POL 40x/0.65 All with anti-fungus treatment.
Specimen stage:	Rotatable stage with locking mechanism and centering knobs. Vernier scale with accuracy 0.1 mm. Diameter 145 mm. Specimen slide clamps.
Focusing:	Coaxial coarse (adjustable tension) and fine focusing mechanism with limit stop to prevent the contact between objective and specimen.
Condenser:	Swing-out N.A. 0.2/0.9, with iris diaphragm, focusable and centerable. With rotating polarizing filter.
Transmitted illumination (Full Koehler type):	X-LED ³ with white 3.6 W LED (6.300 K) with brightness control. Multi-plug 100-240Vac/6Vdc external power supply.

2 B-510POL-I - Polarizing Microscope

Advanced routine laboratory microscope for brightfield and polarized light observations in transmitted and incident light with strain-free IOS LWD W-PLAN POL objectives. Complete of polarizer and analyzer filters, Bertrand lens for conoscopic observation, compensator plates and high-precision rotatable stages. It comes with the exclusive **X-LED³** illumination system to deliver bright and clear images, along with all the accessories to perform accurate polarization analysis in biology and materials science.

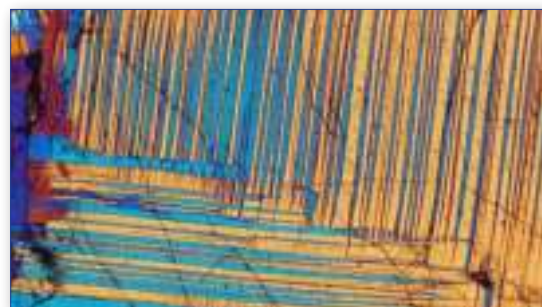

Incident/transmitted light Objectives included

Description
IOS LWD W-PLAN POL 5x/0.12, W.D. 15.5 mm
IOS LWD W-PLAN POL 10x/0.25, W.D. 10.0 mm
IOS LWD W-PLAN POL 20x/0.40, W.D. 5.8 mm
IOS LWD W-PLAN POL 50x/0.75, W.D. 0.32 mm

Part	Description
Observation mode:	Brightfield, transmitted/incident polarized light and conoscopy.
Epi-illumination and filters:	X-LED ³ with white 8 W LED (6.300 K) with brightness control. With polarizer and rotating analyzer for incident illumination, aperture and field diaphragm. With additional filter holder.
Bertrand lens and polarizing attachment:	Swing-out type with centering mechanism for observation in conoscopy/orthoscopy. Rotatable analyzer from 0° to 90° with graduated scale. Tint plates: 1° order red (λ); $\lambda/4$; Quartz wedge.
Head:	Trinocular (fixed 50/50), 30° inclined, 360° rotating.
Interpupillary distance:	Adjustable between 50 and 75 mm.
Dioptric adjustment:	On the left eyepiece tube.
Eyepieces:	WF10x/22 mm, high eye-point and with rubber cups. One with crosshair.
Nosepiece:	Quadruple revolving nosepiece, rotation on ball bearings. Centering system for each objective.

Part	Description
Objectives (strain-free):	IOS LWD W-PLAN POL 5x/0.12 IOS LWD W-PLAN POL 10x/0.25 IOS LWD W-PLAN POL 20x/0.40 IOS LWD W-PLAN POL 50x/0.75 All with anti-fungus treatment.
Specimen stage:	Rotatable stage with locking mechanism and centering knobs. Vernier scale with accuracy 0.1 mm. Diameter 145 mm. Specimen slide clamps.
Focusing:	Coaxial coarse (adjustable tension) and fine focusing mechanism with limit stop to prevent the contact between objective and specimen.
Condenser:	Swing-out N.A. 0.2/0.9, with iris diaphragm, focusable and centerable. With rotating polarizing filter.
Transmitted illumination (Full Koehler type):	X-LED ³ with white 3.6 W LED (6.300 K) with brightness control. Multi-plug 100-240Vac/6Vdc external power supply.

B-510MET - Metallurgical Microscope

Advanced routine laboratory microscope with IOS W-PLAN MET objectives and metallurgical attachment with the exclusive **X-LED³** lighting source for incident illumination only. The NCG (no cover glass) objectives are especially designed for microscopy use without a cover slip ideal for metallographic samples and other opaque specimens.

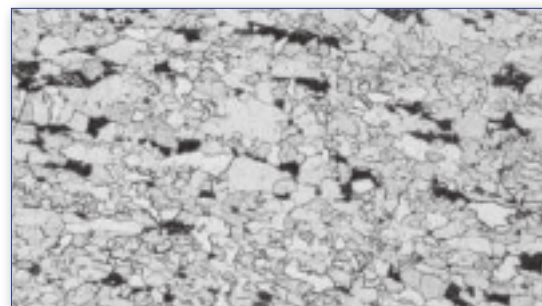

Part	Description
Observation mode:	Brightfield, simple polarized light, oblique illumination on incident light.
Epi-illumination and polarizing filters:	X-LED ³ with white 8 W LED (6.300 K) with brightness control. With aperture and field diaphragms, and oblique illumination system. With polarizer and analyzer. Multi-plug 100-240Vac/6Vdc external power supply.
Head:	Trinocular (fixed 50/50), 30° inclined, 360° rotating.
Interpupillary distance:	Adjustable between 50 and 75 mm.
Dioptric adjustment:	On the left eyepiece tube.
Eyepieces:	WF10x/22 mm, high eye-point and with rubber cups.
Nosepiece:	Quintuple revolving nosepiece, rotation on ball bearings.

Part	Description
Objectives (strain-free):	IOS W-PLAN MET 5x/0.12 IOS W-PLAN MET 10x/0.25 IOS W-PLAN MET 20x/0.40 IOS W-PLAN MET 50x/0.75 All with anti-fungus treatment.
Specimen stage:	Double layer rackless mechanical stage, 233x147 mm, 78x54 mm X-Y range.
Focusing:	Coaxial coarse (adjustable tension) and fine focusing mechanism with limit stop to prevent the contact between objective and specimen.

B-510METR - Metallurgical Microscope

Advanced routine laboratory microscope with IOS W-PLAN MET objectives and metallurgical attachment with the exclusive **X-LED³** lighting source for both transmitted and incident illumination. The NCG (no cover glass) objectives are especially designed for microscopy use without a cover slip ideal for metallographic samples and other opaque specimens.



Part	Description
Observation mode:	Brightfield on transmitted light. Brightfield, simple polarized light, oblique illumination on incident light.
Epi-illumination and polarizing filters:	X-LED ³ with white 8 W LED (6.300 K) with brightness control. With aperture and field diaphragms, and oblique illumination system. With polarizer and analyzer.
Head:	Trinocular (fixed 50/50), 30° inclined, 360° rotating.
Interpupillary distance:	Adjustable between 50 and 75 mm.
Dioptric adjustment:	On the left eyepiece tube.
Eyepieces:	WF10x/22 mm, high eye-point and with rubber cups.
Nosepiece:	Quintuple revolving nosepiece, rotation on ball bearings.

Part	Description
Objectives (strain-free):	IOS W-PLAN MET 5x/0.12 IOS W-PLAN MET 10x/0.25 IOS W-PLAN MET 20x/0.40 IOS W-PLAN MET 50x/0.75 All with anti-fungus treatment.
Specimen stage:	Double layer rackless mechanical stage, 233x147 mm, 78x54 mm X-Y range. With tempered glass plate.
Focusing:	Coaxial coarse (adjustable tension) and fine focusing mechanism with limit stop to prevent the contact between objective and specimen.
Condenser:	Swing-out N.A. 0.2/0.9, with iris diaphragm, focusable and centerable.
Transmitted illumination (Full Koehler type):	X-LED ³ with white 3.6 W LED (6.300 K) with brightness control. Multi-plug 100-240Vac/6Vdc external power supply.

B-510 - Discussion Microscopes

Advanced routine laboratory microscope for brightfield observations with IOS W-PLAN objectives and rackless stage. Ideal for discussion groups and teaching purpose for multiple observers, up to five users simultaneously. A three-color LED pointer facilitates the indication and identification of the object observed. The high-efficiency **X-LED³** makes it reliable for all transmitted light observations for great-looking, rich and high-quality view.



B-510-2F



B-510-2



B-510-3



B-510-5

Part	Description
Observation mode:	Brightfield
Head:	Trinocular (fixed photo port 50/50), 30° inclined, 360° rotating.
Interpupillary distance:	Adjustable between 50 and 75 mm.
Dioptric adjustment:	On the left eyepiece tube.
Eyepieces:	Main head: WF10x/22 mm, high eye-point and with rubber cups. Additional head(s): WF10x/20 mm, high eye-point.
Nosepiece:	Quintuple revolving nosepiece, rotation on ball bearings.
Objectives:	IOS W-PLAN 4x/0.10 IOS W-PLAN 10x/0.25 IOS W-PLAN 40x/0.65 IOS W-PLAN 100x/1.25 (Oil) All with anti-fungus treatment.

Part	Description
Specimen stage:	Double layer rackless mechanical stage, 233x147 mm, 78x54 mm X-Y range.
Focusing:	Coaxial coarse (adjustable tension) and fine focusing mechanism with limit stop to prevent the contact between objective and specimen.
Condenser:	Swing-out N.A. 0.2/0.9, with iris diaphragm, focusable and centerable.
Transmitted illumination (Full Koehler type):	X-LED ³ with white 3.6 W LED (6,300K) with brightness control. Multi-plug 100-240Vac/6Vdc external power supply.

B-510 Series - Comparison chart

Model	Head	Eyepieces	Nosepiece	Attachment	Objectives
B-510BF	Trinocular (50/50), 30° inclined, 360° rotating	WF10x/22mm, high eye-point	Quintuple, reversed	-	IOS W-PLAN 4x, 10x, 40x, 100x (oil)
B-510ERGO	Binocular ergonomical, 30°- 60° inclined 360° rotating	WF10x/22mm, high eye-point	Quintuple, reversed	-	IOS W-PLAN 4x, 10x, 40x, 100x (oil)
B-510PH	Trinocular (50/50), 30° inclined, 360° rotating	WF10x/22mm, high eye-point	Quintuple, reversed	-	IOS W-PLAN PH 10x, 20x, 40x, 100x (oil)
B-510ASB	Trinocular (50/50), 30° inclined, 360° rotating	WF10x/22mm, high eye-point WF12.5x/15mm w/W&B reticle	Quintuple, reversed	-	IOS W-PLAN 4x, 10x, 40xPH, 100x (oil)
B-510DK	Trinocular (50/50), 30° inclined, 360° rotating	WF10x/22mm, high eye-point	Quintuple, reversed	-	IOS W-PLAN 4x, 10x, 40x, 100x with iris diaphragm (oil)
B-510FL	Trinocular (100/0, 50/50, 0/100), 30° inclined, 360° rotating	WF10x/22mm, high eye-point	Quintuple, reversed	Epi-Florescence attachment, with 4-position filterset slider. Equipped with Blue (FITC) and Green (TRITC) filtersets	IOS W-PLAN F 4x, 10x, 20x, 40x (oil)
B-510LD4	Trinocular (3-position 100/0, 50/50, 0/100), 30° inclined, 360° rotating.	WF10x/22mm, high eye-point	Quintuple, reversed	Epi-Florescence attachment, with 3-position filterset slider. Equipped with Blue filterset (FITC)	B-510LD4: IOS W-PLAN 4x, 10x, 40x, 100x (oil) B-510LD4-SA: IOS W-PLAN F 4x, 10x, 40x, 100x (oil)
B-510POL	Trinocular (50/50), 30° inclined, 360° rotating	WF10x/22mm, high eye-point	Quadruple, reversed. Objective positions centrable.	Swing-out Bertrand lens with centering mechanism for observation in conoscopy/orthoscopy. Rotatable analyzer from 0° to 90° with graduated scale. Tint plates: 1° order red (λ); $\lambda/4$; Quartz wedge	IOS W-PLAN POL 4x, 10x, 20x, 40x
B-510POL-I	Trinocular (50/50), 30° inclined, 360° rotating	WF10x/22mm, high eye-point	Quadruple, reversed. Objective positions centrable.	Incident light attachment with Polarizer for incident illumination, with Aperture & Field diaphragms and additional filter holder. Swing-out Bertrand lens with centering mechanism for observation in conoscopy/orthoscopy. Rotatable analyzer from 0° to 90° with graduated scale. Tint plates: 1° order red (λ); $\lambda/4$; Quartz wedge	IOS LWD W-PLAN POL 5x, 10x, 20x, 50x
B-510MET	Trinocular (50/50), 30° inclined, 360° rotating	WF10x/22mm, high eye-point	Quintuple, reversed	Incident light attachment with Polarizer and rotating Analyzer for incident illumination, with Aperture & Field diaphragms and 2 additional filter holders. Oblique illumination	IOS W-PLAN MET 5x, 10x, 20x, 50x
B-510METR	Trinocular (50/50), 30° inclined, 360° rotating	WF10x/22mm, high eye-point	Quintuple, reversed	Incident light attachment with Polarizer and rotating Analyzer for incident illumination, with Aperture & Field diaphragms and 2 additional filter holders; Epi/Transmitted light selector. Oblique illumination	IOS W-PLAN MET 5x, 10x, 20x, 50x
B-510-2F	Trinocular (50/50), 30° inclined, 360° rotating	WF10x/22mm, high eye-point	Quintuple, reversed	Discussion bridge for 2 observers, Face-to-Face type. 2nd binocular head with WF10x/20mm eyepieces. Equipped with RGB discussion pointer	IOS W-PLAN 4x, 10x, 40x, 100x (oil)
B-510-2	Trinocular (50/50), 30° inclined, 360° rotating	WF10x/22mm, high eye-point	Quintuple, reversed	Discussion bridge for 2 observers, Side-by-Side type. 2nd binocular head with WF10x/20mm eyepieces. Equipped with RGB discussion pointer	IOS W-PLAN 4x, 10x, 40x, 100x (oil)
B-510-3	Trinocular (50/50), 30° inclined, 360° rotating	WF10x/22mm, high eye-point	Quintuple, reversed	Discussion bridge for 3 observers. Additional binocular heads with WF10x/20mm eyepieces. Equipped with RGB discussion pointer	IOS W-PLAN 4x, 10x, 40x, 100x (oil)
B-510-5	Trinocular (50/50), 30° inclined, 360° rotating	WF10x/22mm, high eye-point	Quintuple, reversed	Discussion bridge for 5 observers. Additional binocular heads with WF10x/20mm eyepieces. Equipped with RGB discussion pointer	IOS W-PLAN 4x, 10x, 40x, 100x (oil)

B-510 Series - Comparison chart

Stage	Focusing	Condenser	Incident Illumination	Transmitted Illumination
Double layer, 233x147 mm, moving range 78x54 mm, X-axis rackless	Coaxial coarse and fine, limit stop, adjustable tension	Swing-out type, sliding-in, N.A. 0.2/0.9, with centering system	-	X-LED ³ with white 3.6 W LED (6,300K), brightness control. Full Koehler type.
Double layer, 233x147 mm, moving range 78x54 mm, X-axis rackless	Coaxial coarse and fine, limit stop, adjustable tension	Swing-out type, sliding-in, N.A. 0.2/0.9, with centering system	-	X-LED ³ with white 3.6 W LED (6,300K), brightness control. Full Koehler type.
Double layer, 233x147 mm, moving range 78x54 mm, X-axis rackless	Coaxial coarse and fine, limit stop, adjustable tension	Phase condenser (10x/20x, 40x, 100x) with darkfield (dry) and brightfield	-	X-LED ³ with white 3.6 W LED (6,300K), brightness control. Full Koehler type.
Double layer, 233x147 mm, moving range 78x54 mm, X-axis rackless	Coaxial coarse and fine, limit stop, adjustable tension	Abbe N.A. 1.25, with objective-coded iris diaphragm, focusable and centerable. With 40x phase contrast slider.	-	X-LED ³ with white 3.6 W LED (6,300K), brightness control. Full Koehler type.
Double layer, 233x147 mm, moving range 78x54 mm, X-axis rackless	Coaxial coarse and fine, limit stop, adjustable tension	Swing-out type, sliding-in, N.A. 0.2/0.9, with centering system. Additional darkfield condenser, N.A. 1.36, built-in X-LED ³	-	X-LED ³ with white 3.6 W LED (6,300K), brightness control. Full Koehler type.
Double layer, 233x147 mm, moving range 78x54 mm, X-axis rackless	Coaxial coarse and fine, limit stop, adjustable tension	Swing-out type, sliding-in, N.A. 0.2/0.9, with centering system	High Pressure HBO 100 W mercury bulb	X-LED ³ with white 3.6 W LED (6,300K), brightness control. Full Koehler type.
Double layer, 233x147 mm, moving range 78x54 mm, X-axis rackless	Coaxial coarse and fine, limit stop, adjustable tension	Swing-out type, sliding-in, N.A. 0.2/0.9, with centering system	High-power blue LED with brightness control	X-LED ³ with white 3.6 W LED (6,300K), brightness control. Full Koehler type.
Rotating stage with locking mechanism and centering knobs. Vernier scale with accuracy 0.1 mm. Diameter 145 mm; Specimen slide clamps	Coaxial coarse and fine, limit stop, adjustable tension	Swing-out type, sliding-in, N.A. 0.2/0.9, with centering system. With rotating polarizing filter	-	X-LED ³ with white 3.6 W LED (6,300K), brightness control. Full Koehler type.
Rotating stage with locking mechanism and centering knobs. Vernier scale with accuracy 0.1 mm. Diameter 145 mm; Specimen slide clamps	Coaxial coarse and fine, limit stop, adjustable tension	Swing-out type, sliding-in, N.A. 0.2/0.9, with centering system. With rotating polarizing filter	X-LED ³ with white 8 W LED (6,300K), brightness control	X-LED ³ with white 3.6 W LED (6,300K), brightness control. Full Koehler type.
Double layer, 233x147 mm, moving range 78x54 mm, X-axis rackless; with metal plate for metallurgical samples	Coaxial coarse and fine, limit stop, adjustable tension	-	X-LED ³ with white 8 W LED (6,300K), brightness control	-
Double layer, 233x147 mm, moving range 78x54 mm, X-axis rackless; with glass plate for metallurgical samples	Coaxial coarse and fine, limit stop, adjustable tension	Swing-out type, sliding-in, N.A. 0.2/0.9, with centering system	X-LED ³ with white 8 W LED (6,300K), brightness control	X-LED ³ with white 3.6 W LED (6,300K), brightness control. Full Koehler type.
Double layer, 233x147 mm, moving range 78x54 mm, X-axis rackless	Coaxial coarse and fine, limit stop, adjustable tension	Swing-out type, sliding-in, N.A. 0.2/0.9, with centering system	-	X-LED ³ with white 3.6 W LED (6,300K), brightness control. Full Koehler type.
Double layer, 233x147 mm, moving range 78x54 mm, X-axis rackless	Coaxial coarse and fine, limit stop, adjustable tension	Swing-out type, sliding-in, N.A. 0.2/0.9, with centering system	-	X-LED ³ with white 3.6 W LED (6,300K), brightness control. Full Koehler type.
Double layer, 233x147 mm, moving range 78x54 mm, X-axis rackless	Coaxial coarse and fine, limit stop, adjustable tension	Swing-out type, sliding-in, N.A. 0.2/0.9, with centering system	-	X-LED ³ with white 3.6 W LED (6,300K), brightness control. Full Koehler type.
Double layer, 233x147 mm, moving range 78x54 mm, X-axis rackless	Coaxial coarse and fine, limit stop, adjustable tension	Swing-out type, sliding-in, N.A. 0.2/0.9, with centering system	-	X-LED ³ with white 3.6 W LED (6,300K), brightness control. Full Koehler type.

② B-510 Series - Accessories

Eyecups & Eyepieces

M-601	WF15x/16 eyepiece, high eyepoint
M-690	Eyecups (pair)
M-780	PL10x/22 eyepiece, high eyepoint, with rubber cup
M-781	PL10x/22 micrometric eyepiece, high eyepoint, with rubber cup
AA-01	12.5x/18 eyepieces (pair), high eyepoint, focusable, W&B reticle

Objectives

IOS W-PLAN

M-1049	IOS W-PLAN objective 2x/0.05
M-1125	IOS W-PLAN objective 4x/0.10
M-1126	IOS W-PLAN objective 10x/0.25
M-1127	IOS W-PLAN objective 20x/0.40
M-1128	IOS W-PLAN objective 40x/0.65
M-634.1	IOS W-PLAN objective 50x/0.95 (oil)
M-1129	IOS W-PLAN objective 60x/0.80
M-1130	IOS W-PLAN objective 100x/1.25 (oil)
M-1130.1	IOS W-PLAN objective 100x/1.25OI - (oil) with iris for DF

IOS W-PLAN F

M-1060	IOS W-PLAN F objective 4x/0.13
M-1061	IOS W-PLAN F objective 10x/0.30
M-1062	IOS W-PLAN F objective 20x/0.50
M-1063	IOS W-PLAN F objective 40x/0.75
M-1064	IOS W-PLAN F objective 100x/1.30 (oil)

IOS W-PLAN MET

M-336	IOS W-PLAN MET objective 5x/0.12
M-338	IOS W-PLAN MET objective 10x/0.25
M-339	IOS W-PLAN MET objective 20x/0.40
M-335	IOS W-PLAN MET objective 50x/0.75
M-698.2	IOS W-PLAN MET objective 100x/0.80 (dry)

IOS W-PLAN PH

M-1120.N	IOS W-PLAN PH objective 10x/0.25
M-1121.N	IOS W-PLAN PH objective 20x/0.40
M-1122.N	IOS W-PLAN PH objective 40x/0.65
M-1123.N	IOS W-PLAN PH objective 100x/1.25 (oil)

IOS W-PLAN POL

M-1131	IOS W-PLAN POL objective 4x/0.10
M-1132	IOS W-PLAN POL objective 10x/0.25
M-1133	IOS W-PLAN POL objective 20x/0.45
M-1134	IOS W-PLAN POL objective 40x/0.65
M-1135	IOS W-PLAN POL objective 60x/0.80
M-1136	IOS LWD W-PLAN POL objective 5x/0.12
M-1137	IOS LWD W-PLAN POL objective 10x/0.25
M-1138	IOS LWD W-PLAN POL objective 20x/0.40
M-1139	IOS LWD W-PLAN POL objective 50x/0.75



M-1037 - Gout analysis kit



M-635 - Heating stage (on newly purchased microscopes, for 233x147mm), multiplug

B-510 Series - Accessories

Stages

- M-175.1 Rotating stage for polarising set (for 233x147mm rackless stage) (except for B-510PH, B-510ASB and B-510DK)
- M-635 Heating stage (on newly purchased microscopes, for 233x147mm), multiplug

Condensers & Filters

- M-181 PH set - 10x, 20x, 40x, 100x IOS W-PLAN PH obj. & BF/DF/PH condenser
- M-185 Darkfield condenser for dry objectives (except for B-510DK, B-510MET and B-510METR)
- M-636 Polarising set (filters only) (except for B-510POL & B-510POL-I)
- M-637 Fluorescence filter set V (filterblock not needed) (only for B-510FL)
- M-638 Fluorescence filter set UV-DAPI (filterblock not needed) (only for B-510FL)
- M-975 Blue filter, 45mm diameter
- M-977 Green filter, 45mm diameter
- M-979 Yellow filter, 45mm diameter
- M-989 Frosted glass filter, 45mm diameter
- M-1220 Blue LED Fluorescence Cube (LED+Filterset), (only for B-510LD4)
- M-1220.1 Blue (pass band) LED Fluorescence Cube (LED+Filterset), (only for B-510LD4)
- M-1221 Green LED Fluorescence Cube (LED+Filterset), (only for B-510LD4)
- M-1221.1 Green (pass band) LED Fluorescence Cube (LED+Filterset), (only for B-510LD4)
- M-1222 Violet LED Fluorescence Cube (LED+Filterset), (only for B-510LD4)
- M-1223 UV LED Fluorescence Cube (LED+Filterset), (only for B-510LD4)
- M-1223.1 UV (pass band) LED Fluorescence Cube (LED+Filterset), (only for B-510LD4)
- M-1224 Red 1 LED Fluorescence Cube (LED+Filterset), (only for B-510LD4) *
- M-1225 Red 2 LED Fluorescence Cube (LED+Filterset), (only for B-510LD4) *
- M-1226 Deep Red LED Fluorescence Cube (LED+Filterset), (only for B-510LD4) *
- M-1227 Far Red LED Fluorescence Cube (LED+Filterset), (only for B-510LD4) *
- M-1228 Amber LED Fluorescence Cube (LED+Filterset), (only for B-510LD4)

Camera Adapters

- M-113.1 Ring adapter, 30mm (for monocular and binocular microscopes)
- M-115 0.35x C-Mount projection lens
- M-114 0.5x C-Mount projection lens
- M-118 0.75x C-Mount projection lens
- M-173 C-Mount projection lens for APS-C/full frame reflex cameras (trino)
- M-620 0.35x focusable C-Mount adapter (biological microscopes)
- M-620.1 0.5x focusable C-Mount adapter (biological microscopes)
- M-620.2 0.65x focusable C-Mount adapter (biological microscopes)
- M-620.3 1x focusable C-Mount adapter (biological & stereomicroscopes)
- M-699 Universal adapter for C-Mount projection lens (trino)

Miscellaneous

- 15008 Immersion oil, 10ml
- 15009 Immersion oil, 100ml
- 15104 Cleaning kit
- AA-02 HSE-NPL Mark II phase contrast test slide, with certification (only for B-510ASB)
- DC-003 TNT dust cover, medium, 600(l)x550(h) mm
- M-005 Micrometric slide, 26x76mm, with 2 scales (1mm/100 & 10mm/100)
- M-069 Solar charger (except for B-510MET, B-510METR and B-510POL-I)
- M-151 HBO 100W high-pressure mercury bulb for fluorescence (only for B-510FL)
- M-151.1 HBO 100W high-pressure mercury bulb for fluorescence (OSRAM) (only for B-510FL)
- M-1004.N Centering telescope, 30mm diameter (except for B-510MET, B-510METR, B-510POL and B-510POL-I)
- M-1037 Gout analysis kit (only for B-510BF, B-510ERGO and B-510PH)
- VP-510 IQ/OQ/PQ manual for B-510 series
- AB-020 Antibacterial surface treatment, only for newly purchased microscope

* If the use of a camera is needed, when used for red emission fluorescence wavelengths above 650nm, please order it by specifying with "AR GLASS"



How to connect the cameras to our microscopes.

Please refer to the Adapter reference list on Digital section.

15104 - Cleaning kit

It cleans glass quickly and effectively, without leaving residue or odor. Ideal for precision lens or prism cleaning.



M-069 - Solar charger

Included battery: rechargeable – Lithium-Poly.
Capacity: 2500 mAh. - Output voltage: 5 Vdc.
Autonomy: over 6 hours at medium intensity (X-LED³).
Charging models: with solar panel (12h), with external USB power supply (2.5h)



v 7.5 - OPTIKA reserves the right to make corrections, modifications, enhancements, improvements and other changes to its products at any time without notice.

Headquarters and Manufacturing Facilities

OPTIKA® S.r.l. Via Rigla, 30 - 24010 Ponteranica (BG) - ITALY - Tel.: +39 035.571.392 - info@optikamicroscopes.com

Optika Sales branches

OPTIKA® Spain spain@optikamicroscopes.com
OPTIKA® China china@optikamicroscopes.com
OPTIKA® India india@optikamicroscopes.com

OPTIKA® North America namerica@optikamicroscopes.com
OPTIKA® Central America camerica@optikamicroscopes.com
OPTIKA® Africa africa@optikamicroscopes.com

OPTIKA[®]
M I C R O S C O P E S
I T A L Y

B-810 & B-1000



Research Lab Upright Microscopes

B-810/B-1000 - Research Lab Upright Microscopes



B-810/B-1000 - Research Lab Upright Microscopes

2

Laboratory

OPTIKA Microscopes, thanks to the long experience achieved in microscopy development, has conceived the new B-1000: a major leap in our technological offer. As a flagship instrument, B-1000 originates from customer most demanding feedbacks and needs. Its modularity and versatility will allow to find the perfect place in any clinical or basic research laboratory. All controls are easily accessible and comfortable also for extended periods of observation.

B-1000 is built on IOS Infinity Corrected optical system, which gives both top-notch optical performances, and the possibility to extend your instrument with the broad range of accessories and modules. X-LED illumination is the best solution to have pure white light, very intense even at higher magnification, and optimum power efficiency given by solid state source.

If you are looking for our best solution to your present and future professional demands, B-1000 is the answer.



Highest category of optical equipment among our product range guarantees a sharp and clear view in any situation, while top level mechanical design offers sturdiness and long lifetime.



B-810/B-1000 - Research Lab Upright Microscopes



B-810/B-1000 - Research Lab Upright Microscopes

2

Laboratory

Solid Stand – Extra Stability

A completely new design and a die-cast aluminum stand offer solidity and durability, even for the most demanding laboratory use.

This new microscope can seamlessly be upgraded with many attachments that extend its field of use.

X-LED White Illumination

X-LED illumination system is based on a pure white high-efficiency LED and a special optics. It guarantees constant color temperature, no heat, and an extreme electrical consumption efficiency.

The whole system is pre-aligned and boasts a lifetime of 50,000 hours.

X-LED benefits

Powerful pure white LED illumination, ideal for brightfield, darkfield and phase contrast applications.

Constant color temperature through all the intensity levels. No heat generation, avoiding damage of the specimen.

Factory pre-centering assures uniform illumination over the field of view, yet providing perfect Koehler alignment. Very long lifetime and high power efficiency.

Light under control

Intelligent control of the microscope illumination: the "AUTO-OFF" function automatically switches the light off after a user-selectable time period. "BOOST" gives an extra high level of illumination for light-demanding applications. "AUTO" allows to store an illumination level, and to maintain it throughout the inspection.



Ergonomy

Low position focus and stage controls allow a fast and comfortable operation. Frequently used controls as light intensity adjustment and diaphragm are also placed in the lower part of the stand and enable operation without having to take the eyes off the specimen. All optical heads are equipped with high-point eyepieces and dioptic adjustment, for the best viewing experience.

B-810/B-1000 - Research Lab Upright Microscopes



Modularity – Build your own solution

Many worlds in one instrument. Modularity allows to build the desired solution (brightfield, darkfield, phase contrast, material science, fluorescence, motorized automation and so on). B-1000 has the flexibility to help your work the best way.

Comfortable Stage

Refined belt-driven stage, with a wide working surface and a highly precise XY movement.

High Quality IOS Optical System

Infinity corrected optical system, based on planachromatic, fluorite and semi-apochromatic objectives, designed to give sharp and clear images, both for the user and the digital camera. Quintuple and sextuple nosepieces give the flexibility to build the objectives that best suits your needs. The system is completed with wide field, high-point eyepieces, with a field number of 24mm.

Ready for Digital Imaging

Range of adapters can accommodate for C-mount digital cameras, as well as reflex cameras. Focus adjustment gives perfectly clear digital images. Our cameras include specific software for capturing, measuring, marking and storing your images. Pro View software allows to perform image acquisition, post-processing, measurements and storage of your images. User can save a preset for later work, or even create a multi-focus composition.



B-810/B-1000 - Research Lab Upright Microscopes

2

Laboratory

Remote-controlled microscope

The stage can be remote-controlled through a dedicated software: X, Y, Z axes, as well as nosepiece, can be moved with a single click. Communication protocol is available for interfacing with custom software, such as automated analysis or autofocus.



X-Y-Z motorized stage
Motorized nosepiece



B-810/B-1000 - Observation Methods

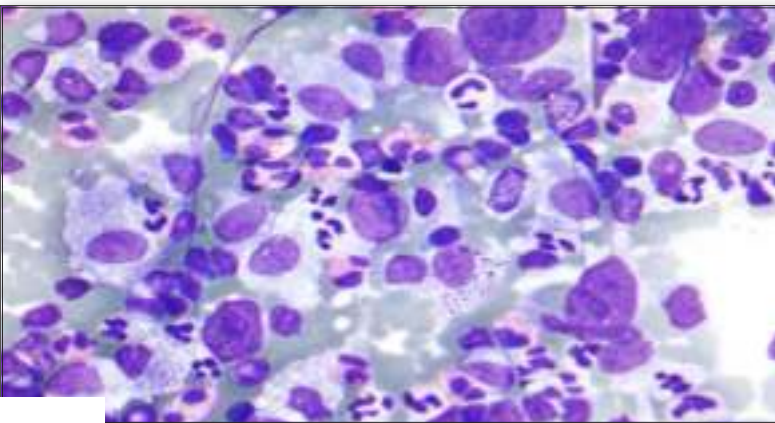

Pathology / Cytology

Since B-810 / B-1000 use white LED illumination, they can maintain the same color temperature even if the brightness is changed. "AUTO" function automatically adjusts the light intensity when the objective is changed or the aperture diaphragm is set to a different value.

These features, along with motorized stage and ergonomic controls, make your workflow easier.

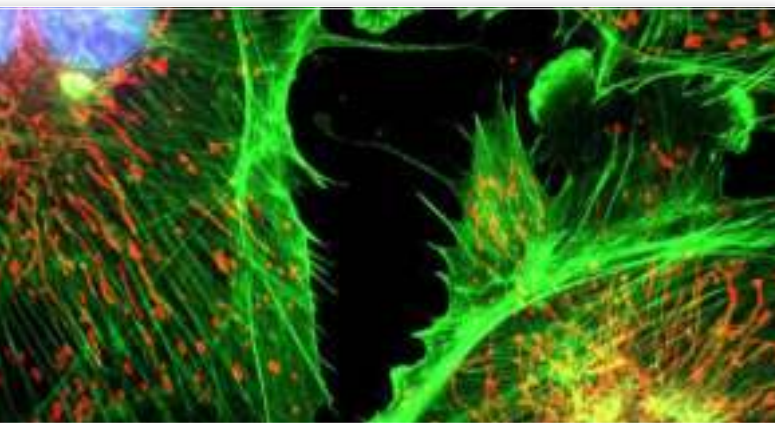

Fluorescence Microscopy

A new attachment for epi-fluorescence provides the ultimate solution in the field of fluorescence diagnostic. Vibration-free six positions filter wheel with shutter, field and aperture diaphragms offer all you need for a complete analysis. Custom filtersets are available and mounted on request. For application where efficiency, rapidity and ease of use are crucial, this model offers also a LED epi-fluorescence attachment, with very high power standard illuminators.

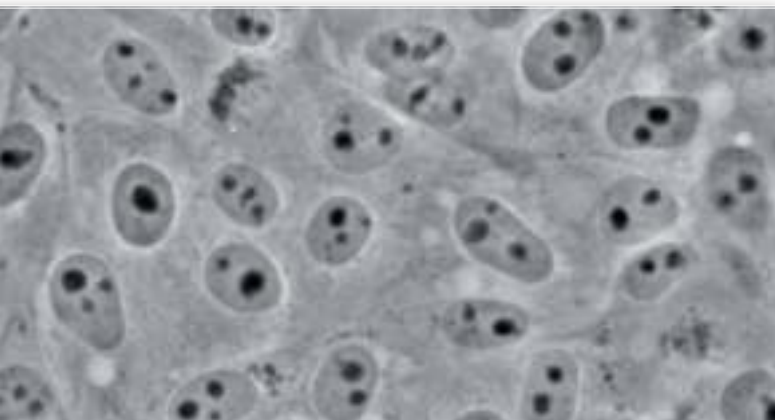

Phase Contrast Microscopy

The bright LED illuminator brings a comfortable view in phase contrast with all magnifications. Universal wheel condenser allows to quickly switch between brightfield, darkfield and phase contrast.

Ideal for clinical laboratories or fibers (e.g. asbestos) analysis.

Darkfield Microscopy

Ideal for observing blood cells, diatoms, small insects, bone, fibers, unstained bacteria, yeast, protozoa, mineral and chemical crystals, colloidal particles, dust-count specimens, and thin sections of polymers and ceramics.

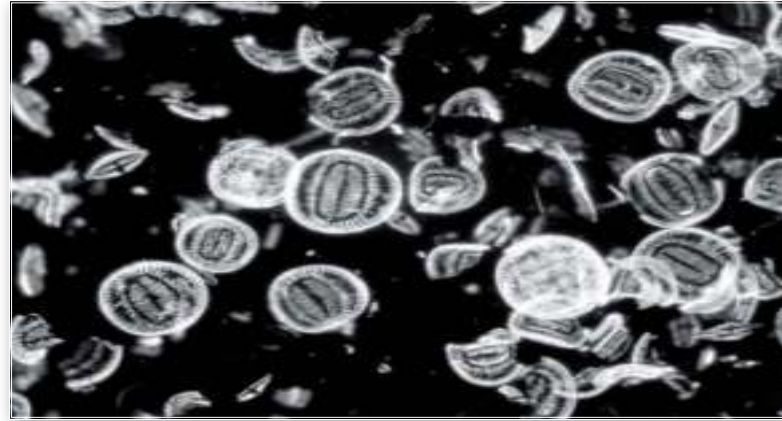

Material Science

A new attachment designed specifically for metallographic inspection, with dedicated objectives set, for the most complete epi-illumination analysis: brightfield, darkfield and polarizing view observations.

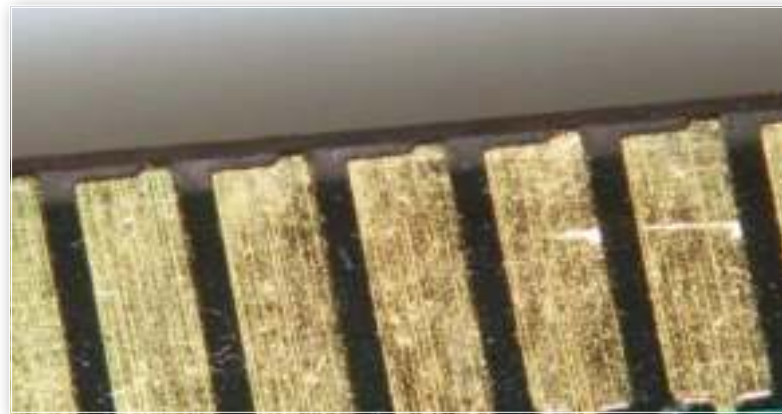

Polarizing Microscopy

Polarized light microscopy is used in geological applications or also for both natural and industrial minerals, composites such as concretes, ceramics, mineral fibers and polymers, and crystalline or biological molecules such as DNA, starch, wood and urea.

Attachments for a full polarization analysis are available (both for transmitted and incident light), so it's possible to look at color fringes right away.

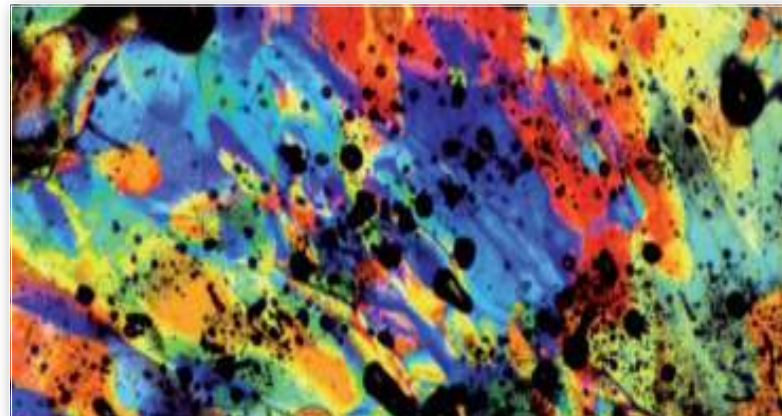

B-810/B-1000 - Design and Production

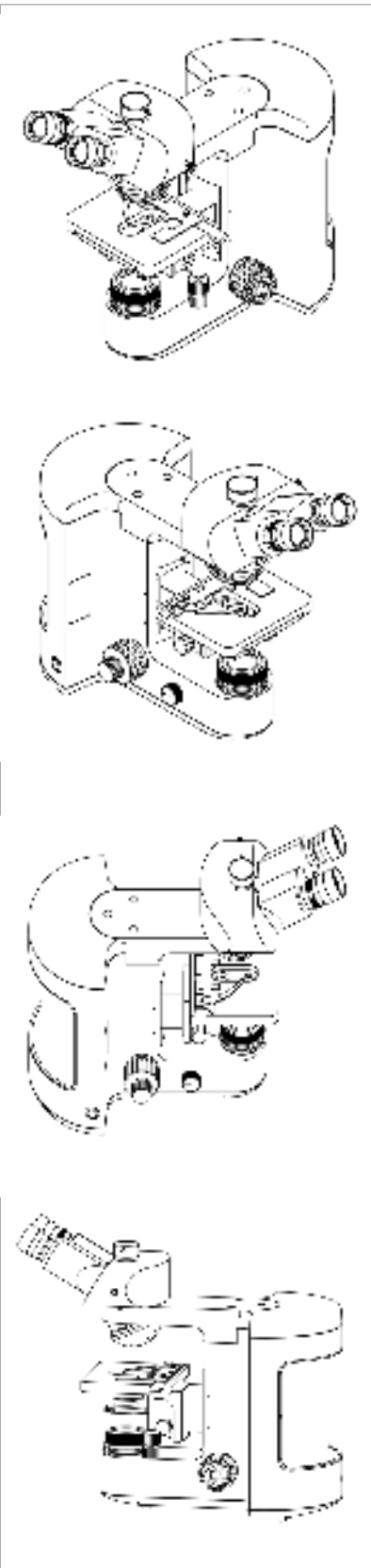

B-810/B-1000 - Design and Production

OPTIKA workshop provides the facilities for precise and reliable optomechanical manufacturing, essential for this kind of instruments.

CNC machining department, equipped with 5-axis milling machine and lathe.



Die-cast stands ready to be processed.



Work in progress inside the milling machine.



Microscope stands exiting from the internal varnishing facility.



All processes are carefully monitored through the application of **ISO 9001 Quality System standards**.

② B-810/B-1000 - Components

Eyepieces



M-1001

PL10x/22 eyepieces (pair), high eyepoint, with rubber cup (retractable)



M-1002

PL10x/24 eyepieces (pair), high eyepoint, with rubber cup (retractable); for B-1000 only



M-1003

PL15x/16 eyepieces (pair), high eyepoint



M-781

PL10x/22 eyepiece, high eyepoint, with micrometric scale (10mm/100um) & rubber cup (retractable)



AA-01

12.5x/15 eyepieces (pair), high eyepoint, with dioptic adjustment, one with W&B graticule for Asbestos



M-1004.N

Centering telescope



Heads



M-1010

Trinocular head, two positions (100/0, 50/50) for B-1000



M-1011

Trinocular head, three positions (100/0, 50/50, 0/100) for B-1000



M-1012

Binocular ERGO head for B-1000



M-1013

Trinocular ERGO head, two positions (100/0, 50/50) for B-1000



M-1188

Trinocular head, single position (50/50) for B-810



Bodies



Multi-plug power supply

M-1187

Main body with focus system and X-LED³ illumination for B-810.

**M-1021B**

Main body with focus system and X-LED⁸ illumination, for general purposes for B-1000.

**M-1021M**

Main body with focus system and X-LED⁸ illumination, for brightfield metallurgical B-1000.

**M-1022M**

Main body with focus system (incident light only) for brightfield metallurgical B-1000.

**M-1021MD**

Main body with focus system and X-LED⁸ illumination, for brightfield/darkfield metallurgical B-1000B-1000.

**M-1022MD**

Main body with focus system (incident light only), for brightfield/darkfield metallurgical B-1000.

**M-1156**

Upgrade (controller) for any kind of motorization (stage, Z-axis, nosepiece, or all of them together); for B-1000

M-1149

Motorization of Z-axis for B-1000

Nosepieces



M-1040

Quintuple reversed nosepiece, for RMS objectives; for B-810



M-1041

Sextuple reversed nosepiece, for RMS objectives; for B-810



M-1042

Sextuple reversed nosepiece, for RMS objectives with DIC slot; for B-1000



M-1043

Sextuple motorized reversed nosepiece, for RMS objectives with DIC slot; for B-1000



M-1044

Quintuple reversed nosepiece, with centrable positions for POL objectives; for B-1000



2 B-810/B-1000 - Components

W-PLAN Objectives



Plan Objectives - IOS W-PLAN Series



- M-1049** IOS W-PLAN 2x/0.05
- M-1125** IOS W-PLAN 4x/0.10
- M-1126** IOS W-PLAN 10x/0.25
- M-1127** IOS W-PLAN 20x/0.40
- M-1128** IOS W-PLAN 40x/0.65
- M-1129** IOS W-PLAN 60x/0.80
- M-1130** IOS W-PLAN objective 100x/1.25 (oil)
- M-1130.1** IOS W-PLAN objective 100x/1.25 (Iris)

Plan Objectives - IOS W-PLAN PH Series

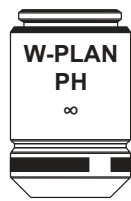

- M-1120.N** IOS W-PLAN PH 10x/0.25
- M-1121.N** IOS W-PLAN PH 20x/0.40
- M-1122.N** IOS W-PLAN PH 40x/0.65
- M-1123.N** IOS W-PLAN PH 100x/1.25 (oil)

Plan Semi-APO Objectives - IOS W-PLAN F Series



- M-1060** IOS W-PLAN F 4x/0.13
- M-1061** IOS W-PLAN F 10x/0.30
- M-1062** IOS W-PLAN F 20x/0.50
- M-1063** IOS W-PLAN F 40x/0.75
- M-1064** IOS W-PLAN F 100x/1.30 (oil)

Plan Objectives - IOS U-PLAN POL Series



- M-1080** IOS U-PLAN POL 4x/0.10
- M-1081** IOS U-PLAN POL 10x/0.25
- M-1081.5** IOS U-PLAN POL 20x/0.45
- M-1082** IOS U-PLAN POL 40x/0.65
- M-1083** IOS U-PLAN POL 60x/0.85

Plan Objectives - IOS LWD W-PLAN MET Series



- M-1099** IOS LWD W-PLAN MET 2.5x/0.08 (with depolarizer)

U-PLAN Objectives



Plan Semi-APO Objectives - **IOS U-PLAN F Series**



- M-1075** IOS U-PLAN F 4x/0.13
- M-1076** IOS U-PLAN F 10x/0.30
- M-1077** IOS U-PLAN F 20x/0.50
- M-1078** IOS U-PLAN F 40x/0.75
- M-1079** IOS U-PLAN F 100x/1.30 (oil)

Plan APO Objectives - **IOS U-PLAN APO Series**



- M-1301** IOS U-PLAN APO 2x/0.08
- M-1302** IOS U-PLAN APO 4x/0.13
- M-1303** IOS U-PLAN APO 10x/0.40
- M-1304** IOS U-PLAN APO 20x/0.75
- M-1305** IOS U-PLAN APO 40x/0.95
- M-1306** IOS U-PLAN APO 60x/0.90
- M-1307** IOS U-PLAN APO 100x/1.35

Plan Semi-APO Objectives - **IOS U-PLAN F PH Series**



- M-1310** IOS U-PLAN F PH 4x/0.13
- M-1311** IOS U-PLAN F PH 10x/0.40
- M-1312** IOS U-PLAN F PH 20x/0.75
- M-1313** IOS U-PLAN F PH 40x/0.95
- M-1314** IOS U-PLAN F PH 60x/0.90
- M-1315** IOS U-PLAN F PH 100x/1.35

M-1157 universal condenser required

Plan Objectives - **IOS LWD U-PLAN POL Series**

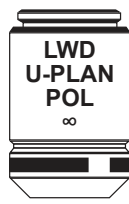

- M-1090** IOS LWD U-PLAN POL 5x/0.15
- M-1091** IOS LWD U-PLAN POL 10x/0.30
- M-1092** IOS LWD U-PLAN POL 20x/0.45
- M-1093** IOS LWD U-PLAN POL 50x/0.55

Plan Objectives - **IOS LWD U-PLAN MET Series**



- M-1100** IOS LWD U-PLAN MET 5x/0.15
- M-1101** IOS LWD U-PLAN MET 10x/0.30
- M-1102** IOS LWD U-PLAN MET 20x/0.45
- M-1103** IOS LWD U-PLAN MET 50x/0.55
- M-1104** IOS LWD U-PLAN MET 100x/0.80 (dry)

Plan Semi-APO Objectives - **IOS LWD U-PLAN F MET Series**

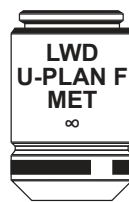

- M-1171** IOS LWD U-PLAN F MET 5x/0.15
- M-1172** IOS LWD U-PLAN F MET 10x/0.30
- M-1173** IOS LWD U-PLAN F MET 20x/0.50
- M-1174** IOS LWD U-PLAN F MET 50x/0.80
- M-1175** IOS LWD U-PLAN F MET 100x/0.90 (dry)

Plan Objectives - **IOS LWD U-PLAN MET BD (Darkfield) Series**

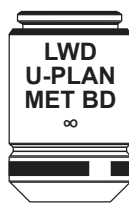

- M-1094** IOS LWD U-PLAN MET BD 5x/0.15
- M-1095** IOS LWD U-PLAN MET BD 10x/0.30
- M-1096** IOS LWD U-PLAN MET BD 20x/0.45
- M-1097** IOS LWD U-PLAN MET BD 50x/0.55
- M-1098** IOS LWD U-PLAN MET BD 100x/0.80 (dry)

Plan Semi-APO Objectives - **IOS LWD U-PLAN F MET BD Series**

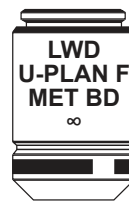

- M-1180** IOS LWD U-PLAN F MET BD 5x/0.15
- M-1181** IOS LWD U-PLAN F MET BD 10x/0.30
- M-1182** IOS LWD U-PLAN F MET BD 20x/0.50
- M-1183** IOS LWD U-PLAN F MET BD 50x/0.80
- M-1184** IOS LWD U-PLAN F MET BD 100x/0.90 (dry)

② B-810/B-1000 - Components

Stages



M-1140

Standard mechanical stage; 175x145mm for B-1000



M-1141

Rackless mechanical stage; movement knobs with friction adjustment control; 242x157mm; for B-1000.



M-1143

MPC (Mineral Solid Surface) rackless mechanical stage; movement knobs with friction adjustment control; 242x157mm; for B-1000.



M-1148

Metallurgical stage with glass, for metallurgical model; 175x145mm; for B-1000



M-1190

Rackless mechanical stage; 220x149mm; for B-810



Stages



M-1145 + M-1146

Rotating Stage, centrable + attachable XY stage; dia. 172mm; for B-1000



M-1147

Motorized mechanical stage; 242x157mm; for B-1000



M-1144

Heating stage, with digital temperature controller; 175x145mm; for B-1000.



M-1190H

Heating stage, with digital temperature controller; 220x149mm; for B-810.



② B-810/B-1000 - Components

Condensers



M-1189

0.90 N.A. swing-out condenser for B-810



M-1150

0.90 N.A. swing-out condenser for B-1000



M-1191

1.2 N.A. swing-out condenser for B-810



M-1151

1.2 N.A. swing-out condenser for B-1000



M-1155

0.9/0.25 N.A. swing-out condenser (to be used with objective M-1049) for B-1000



M-1154

0.70 N.A. swing-out MET condenser for B-1000



Condensers

M-1157 8-Position universal condenser for B-1000



Parts for the universal condenser M-1157

- M-1205** Top lens 0.2 N.A.
- M-1206** Top lens 0.9 N.A.
- M-1207** Top lens 1.4 N.A.
- M-1208** DIC 10x prism
- M-1209** DIC 20x prism
- M-1210** DIC 40x/60x prism
- M-1212** 10x/20x phase ring
- M-1213** 40x/60x phase ring
- M-1214** 100x phase ring
- M-1215** 4x phase ring
- M-1216** Darkfield stop (dry)
- M-1217** Darkfield stop (oil)

M-1153
0.90 N.A. swing-out POL
condenser for B-1000



M-618
Darkfield condenser for dry
objectives for B-1000



M-185
Darkfield condenser for dry
objectives for B-810



M-1124.NO
Phase contrast condenser
with insert slide
10x/20x-40x for B-810



M-1124
Phase contrast condenser
with insert slide
10x/20x-40x for B-1000



M-1152.NO
Phase contrast condenser
10x, 20x, 40x, 100x, BF, DF
for B-810



M-1152.N
Phase contrast condenser
10x, 20x, 40x, 100x, BF, DF
for B-1000



Attachments

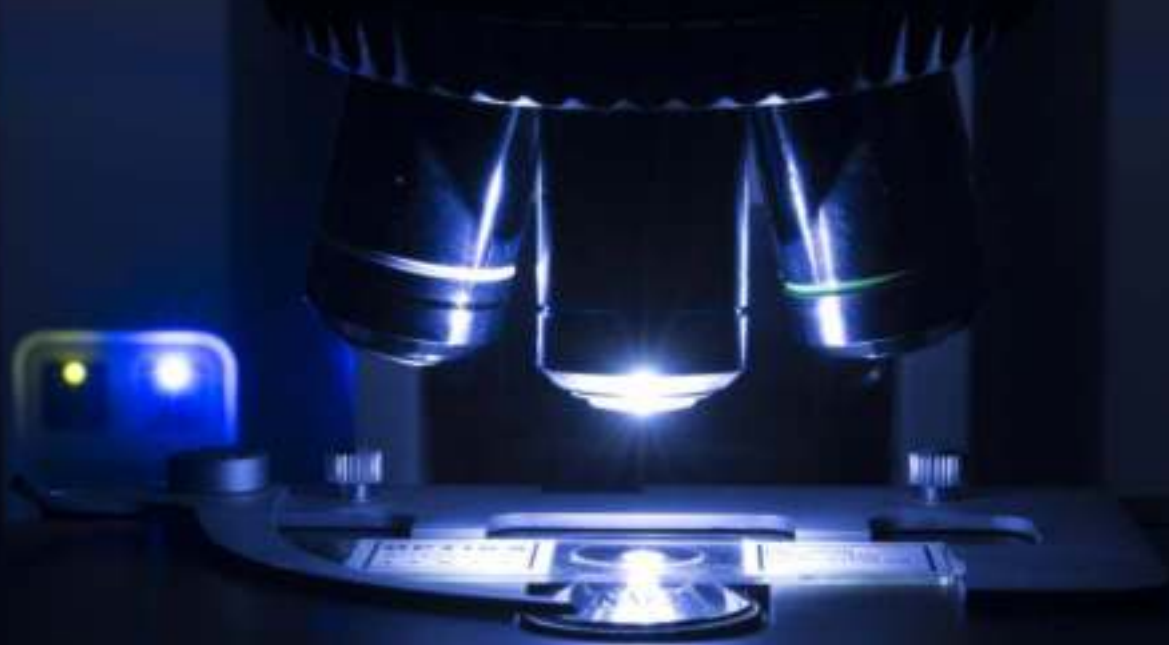

Fluorescence attachments

M-1031M

4-position LED Fluorescence attachment. Without LED-Filtersets (see B-1000 4FLD page for choice); for B-1000



M-1032

6-position HBO Fluorescence attachment, with standard Blue and Green filtersets (FITC & TRITC). With Aperture & Field Diaphragms; for B-1000.



Polarizing attachments

M-1033

Bertrand lens with analyzer and slot for sliders (with Lambda, 1/4 Lambda and Quartz Edge); for B-1000



M-1034

8W X-LED incident polarizing attachment. With Aperture & Field Diaphragms; for B-1000



ALC attachments

M-1030

Automatic Light Control (ALC) system for B-1000



Attachments



Metallurgical attachments

M-1039

Metallurgical attachment for incident brightfield observation, 18 W LED. Equipped with Polarizer and rotating Analyzer. With Aperture & Field Diaphragms. For B-1000.



M-1039MD

Metallurgical attachment for incident brightfield and darkfield observation, 18 W LED. Equipped with Polarizer and rotating Analyzer; with Aperture & Field Diaphragms. Built-in MET nosepiece with 6-positions for 26 mm-Darkfield Metallurgical Objectives. 3 ring adapters for RMS objectives included. For B-1000.



B-810/B-1000 - Components

Discussion Bridges for B-1000



M-1163



M-1159



M-1160



M-1161



M-1162

M-1159
Discussion Bridge with 1 extra head.
Face-to-Face type

M-1160
Discussion Bridge with 1 extra head.
Side-by-Side type

M-1161
Discussion Bridge with 2 extra heads

M-1162
Discussion Bridge with 4 extra heads

M-1163
Discussion Bridge with 9 extra heads

All Discussion Bridges are equipped with extra heads with WF10x/20mm eyepieces

Application Sets

Koehler DIC transmitted

- M-550** - Interferential green filter IF550.
- M-190P** - Polarizer for transmitted light.
- M-1201** - Analyzer for transmitted light.
- M-1202** - DIC prism for transmitted light.



Usable objective series: **IOS W-PLAN F**, **IOS U-PLAN F**. (See page 164)

Transmitted Koehler DIC combined with Fluo HBO

- M-550** - Interferential green filter IF550.
- M-190P** - Polarizer for transmitted light.
- M-1203** - Analyzer for reflected light.
- M-1202** - DIC prism for transmitted light.



Usable objective series: **IOS W-PLAN F**, **IOS U-PLAN F**. (See page 164)

Nomarski DIC transmitted

- M-1157** - 8-Position universal condenser.
- M-1206** - Top lens 0.9 N.A.
- M-1208** - DIC 10x prism for universal condenser.
- M-1209** - DIC 20x prism for universal condenser.
- M-1210** - DIC 40x/60x prism for universal condenser.
- M-1201** - Analyzer for transmitted light.
- M-1202** - DIC prism for transmitted light.



Usable objective series: **IOS U-PLAN F**, **IOS U-PLAN APO**, **IOS U-PLAN F PH**. (See page 162)

Transmitted Nomarski DIC combined with Fluo HBO

- M-1157** - 8-Position universal condenser.
- M-1206** - Top lens 0.9 N.A.
- M-1208** - DIC 10x prism for universal condenser.
- M-1209** - DIC 20x prism for universal condenser.
- M-1210** - DIC 40x/60x prism for universal condenser.
- M-1203** - Analyzer for reflected light.
- M-1202** - DIC prism for transmitted light.



Usable objective series: **IOS U-PLAN F**, **IOS U-PLAN APO**, **IOS U-PLAN F PH**. (See page 162)

Nomarski DIC reflected for metallurgical appl.

- M-870** - DIC prism for metallurgical reflected light.



Usable objective series: **IOS LWD U-PLAN F MET Series**
IOS LWD U-PLAN F MET BD Series.

(See page 162)

GOUT analysis kit

- M-1037** - GOUT analysis kit



B-810 - Brightfield & Phase Contrast Microscope

B-810 is the result of the long experience gathered by OPTIKA Microscopes in the field of light microscopy, offering an extremely valuable product for routine and research laboratory brightfield & phase contrast applications.

Ergonomic design for comfortable long-term use and smooth operation with minimal movements meets the concept of modularity, to offer a the possibility to create a tailored version and match all the personal requirements.

It is qualified as an particularly performing and robust solution, considering the field of view of 22 mm, the state-of-the-art, exclusive **X-LED³** lighting source (3.6 W) and the sturdy dye-cast frame for high stability combined with a wide variety of heads, objectives and condensers to get the most out of a microscope.



B-810 - Configuration Chart

Build the microscope that suites your needs by choosing among the components



2 B-1000BF - Brightfield Microscope

The modular OPTIKA B-1000 helps you working in a comfortable way during extended periods of use and let you perform reliable, accurate and rapid diagnosis benefiting from modularity, which gives the chance to create customized configurations tailored on customer needs.

Versatile, robust, durable and sturdy, B-1000 offers premium quality optics (including Semi-Apo objectives), the state-of-the-art, exclusive **X-LED⁸** (8 W) illumination system, designed by OPTIKA and the Koehler diaphragm. B-1000 gives multiple options as manual or motorized configuration, with the possibility of **ALC** (Automatic Light Control) and a variety of objectives, stages and condensers.



B-1000BF - Configuration Chart

Build the microscope that suites your needs by choosing among the components

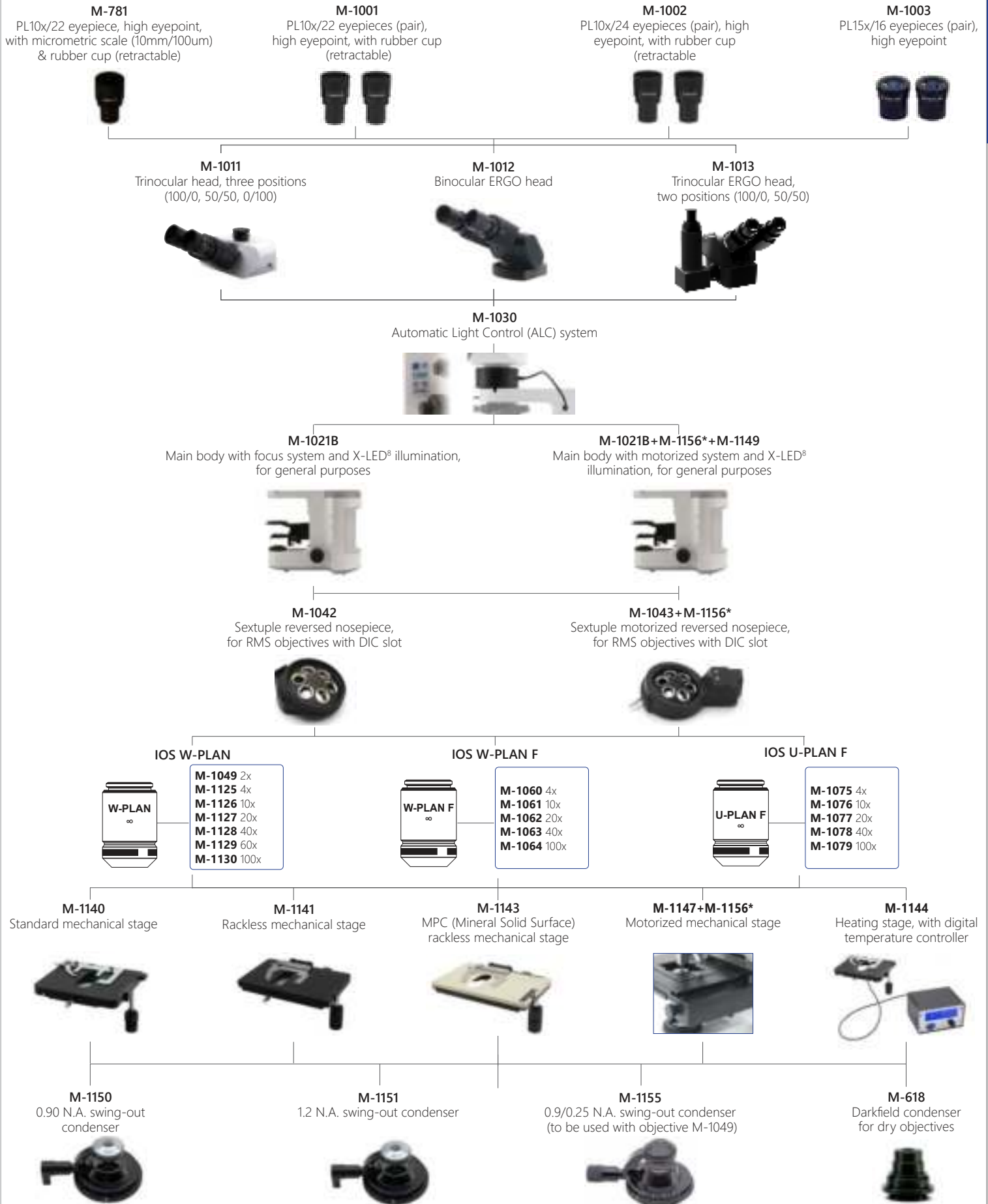

* Code M-1156 must be added only **once** for any motorized configuration

② B-1000PH - Phase Contrast Microscope

The modular OPTIKA B-1000 is available in phase contrast and helps you working in a comfortable way during extended periods of use performing reliable, accurate and rapid diagnosis benefiting from modularity, which gives the chance to create customized configurations tailored on customer needs. Versatile, robust, durable and sturdy, B-1000 offers premium quality optics, the state-of-the-art, exclusive **X-LED⁸** (8 W) illumination system, designed by OPTIKA and the Koehler diaphragm. B-1000 gives multiple options as manual or motorized configuration, with the possibility of **ALC** (Automatic Light Control) and a variety of objectives, stages and condensers.



22



24



B-1000PH - Configuration Chart

Build the microscope that suites your needs by choosing among the components

M-781
PL10x/22 eyepiece,
high eyepoint,
with micrometric scale
(10mm/100um) & rubber cup
(retractable)



M-1001
PL10x/22 eyepieces
(pair), high eyepoint,
with rubber cup
(retractable)

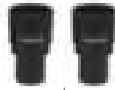

M-1002
PL10x/24 eyepieces
(pair), high eyepoint,
with rubber cup
(retractable)



M-1004.N
Centering telescope



M-1003
PL15x/16 eyepieces
(pair),
high eyepoint



AA-01
12.5x/18 eyepieces (pair),
high eyepoint, with dioptric
adjustment, one with W&B
reticle for Asbestos



M-1011
Trinocular head, three positions
(100/0, 50/50, 0/100)



M-1012
Binocular ERGO head



M-1013
Trinocular ERGO head,
two positions (100/0, 50/50)



M-1030
Automatic Light Control (ALC) system



M-1021B
Main body with focus system and X-LED[®] illumination,
for general purposes



M-1021B+M-1156*+M-1149
Main body with motorized system and X-LED[®] illumination,
for general purposes



M-1042
Sextuple reversed nosepiece,
for RMS objectives with DIC slot



M-1043+M-1156*
Sextuple motorized reversed nosepiece,
for RMS objectives with DIC slot



IOS W-PLAN PH



M-1120.N 10x
M-1121.N 20x
M-1122.N 40x
M-1123.N 100x

M-1140
Standard mechanical stage



M-1141
Rackless mechanical stage



M-1143
MPC (Mineral Solid Surface)
rackless mechanical stage



M-1147+M-1156*
Motorized mechanical stage



M-1144
Heating stage, with digital
temperature controller



M-1124
Phase contrast condenser with
insert slide 10x-40x



M-1152.N
Phase contrast condenser 10x, 20x, 40x,
100x, BF, DF



M-977
Green filter, 45mm



* Code M-1156 must be added only **once** for any motorized configuration

② B-1000FL-HBO - HBO Fluorescence Microscope

The modular OPTIKA B-1000 can stand a HBO fluorescence attachment, helping you working in a comfortable way during extended periods of use and performing reliable, accurate and rapid diagnosis benefiting from modularity, which gives the chance to create customized configurations tailored on customer needs. Versatile, robust, durable and sturdy, B-1000 offers premium quality optics (including Semi-Apo objectives), the state-of-the-art, exclusive **X-LED⁸** (8 W) illumination system, designed by OPTIKA and the Koehler diaphragm. B-1000 gives multiple options as manual or motorized configuration, with a variety of objectives, stages and condensers.

Standard filterset

Name	Excitation filter (nm)	Dichroic mirror cut-off (nm)	Emission filter (nm)
B Blue	460 - 490	500	520LP
G Green	510 - 550	570	590LP

Additional filterset (optional)

Name	Excitation filter (nm)	Dichroic mirror cut-off (nm)	Emission filter (nm)
V (Violet)	400 - 410	455	455LP
UV	330 - 385	400	420LP



B-1000FL-HBO - Configuration Chart

Build the microscope that suites your needs by choosing among the components



* Code M-1156 must be added only **once** for any motorized configuration

2 B-1000LD4 - LED Fluorescence Microscope

The modular OPTIKA B-1000 can stand a LED fluorescence attachment, helping you working in a comfortable way during extended periods of use and performing reliable, accurate and rapid diagnosis benefiting from modularity, which gives the chance to create customized configurations tailored on customer needs. Versatile, robust, durable and sturdy, B-1000 offers premium quality optics (including Apo and Semi-Apo objectives), the state-of-the-art, exclusive **X-LED⁸** (8 W) illumination system, designed by OPTIKA and the Koehler diaphragm. B-1000 gives multiple options as manual or motorized configuration, with a variety of objectives, stages and condensers.

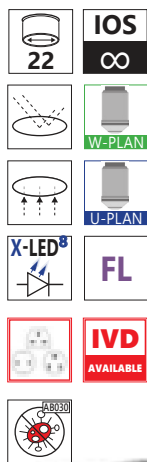

A new milestone achieved in Fluorescence Microscopy

- » Full-modular Fluorescence System
- » Interchangeable LED-Filtersets
- » 4 LED-Filtersets slots
- » 10% higher light intensity than HBO
- » 35% higher light intensity than Metal-Halide
- » Adjustable light intensity
- » The selection of filtersets automatically involves the switching on of the corresponding LEDs
- » Recommended for research applications
- » Cost-effective, money saving technology
- » Ready for immediate operation
- » Eliminate warm-up/cool-down times
- » Forget lamp replacement & centering

LED Fluorescence Cubes available (LED + Filterset)

Name	LED emission (nm)	Excitation filter (nm)	Dichroic mirror cut-off (nm)	Emission filter (nm)
M-1220 - Blue	460	455 - 495	500	510LP
M-1220.1 - Blue (pass band)	460	455 - 495	500	518-542
M-1221 - Green	523	510 - 550	570	575LP
M-1221.1 - Green (pass band)	523	510 - 550	570	585-625
M-1222 - Violet	405	390 - 420	440	450LP
M-1223 - UV	365	325 - 375	415	435LP
M-1223.1 - UV (pass band)	365	340 - 390	405	420-470
M-1224 - Red 1 *	623	590 - 650	660	665LP
M-1225 - Red 2 *	623	595 - 645	655	665 - 715
M-1226 - Deep Red *	660	623 - 678	685	690 - 750
M-1227 - Far Red *	740	720 - 760	770	780LP
M-1228 - Amber	590	582 - 603	610	615 - 645

* If the use of a camera is needed, when used for red emission fluorescence wavelengths above 650nm, please order OPTIKA camera code C-P6AR.

B-1000LD4 - Configuration Chart

Build the microscope that suites your needs by choosing among the components

M-781
PL10x/22 eyepiece, high eyepoint,
with micrometric scale (10mm/100um)
& rubber cup (retractable)



M-1001
PL10x/22 eyepieces (pair),
high eyepoint, with rubber cup
(retractable)



M-1003
PL15x/16 eyepieces (pair),
high eyepoint



M-1011
Trinocular head, three positions
(100/0, 50/50, 0/100)



M-1012
Binocular ERGO head



M-1031M
4-position LED Fluorescence attachment,
without LED Fluorescence Filtersets



M-1220 ... M-1228
LED Fluorescence Cubes
(LED + Filterset)

M-1021B
Main body with focus system and X-LED[®]
illumination, for general purposes



M-1021B+M-1156*+M-1149
Main body with motorized system and X-LED[®]
illumination, for general purposes



M-1042
Sextuple reversed nosepiece,
for RMS objectives with DIC slot



M-1043+M-1156*
Sextuple motorized reversed nosepiece,
for RMS objectives with DIC slot



IOS W-PLAN



M-1049 2x
M-1125 4x
M-1126 10x
M-1127 20x
M-1128 40x
M-1129 60x
M-1130 100x

IOS W-PLAN F



M-1060 4x
M-1061 10x
M-1062 20x
M-1063 40x
M-1064 100x

IOS U-PLAN F



M-1075 4x
M-1076 10x
M-1077 20x
M-1078 40x
M-1079 100x

M-1140
Standard mechanical stage



M-1141
Rackless mechanical stage



M-1143
MPC (Mineral Solid Surface)
rackless mechanical stage



M-1147+M-1156*
Motorized mechanical stage



M-1144
Heating stage, with digital
temperature controller



M-1150
0.90 N.A. swing-out
condenser



M-1151
1.2 N.A. swing-out condenser



M-1155
0.9/0.25 N.A. swing-out condenser
(to be used with objective M-1049)



M-618
Darkfield condenser
for dry objectives



* Code M-1156 must be added only **once** for any motorized configuration

B-1000POL - Polarizing Microscope

The modular OPTIKA B-1000 is available with transmitted polarized light, helping you working in a comfortable way during extended periods of use and performing reliable, accurate and rapid diagnosis benefiting from modularity, which gives the chance to create customized configurations tailored on customer needs. Versatile, robust, durable and sturdy, B-1000 offers premium quality optics, the state-of-the-art, exclusive **X-LED⁸** (8 W) illumination system, designed by OPTIKA and the Koehler diaphragm.

B-1000 gives multiple options as manual or motorized configuration.



22



24



Dedicated version for transmitted
(**X-LED⁸**, 8 W)
illumination and polarization analysis.

B-1000POL - Configuration Chart

Build the microscope that suites your needs by choosing among the components



* Code M-1156 must be added only **once** for any motorized configuration

② B-1000POL-I - Polarizing Microscope

The modular OPTIKA B-1000 is available with transmitted and incident polarized light, helping you working in a comfortable way during extended periods of use and performing reliable, accurate and rapid diagnosis benefiting from modularity, which gives the chance to create customized configurations tailored on customer needs. Versatile, robust, durable and sturdy, B-1000 offers premium quality optics, the state-of-the-art, exclusive **X-LED[®]** (8 W) illumination system, designed by OPTIKA and the Koehler diaphragm. B-1000 gives multiple options as manual or motorized configuration.



Dedicated version for transmitted and incident illumination (**X-LED[®]**, 8 W)



B-1000POL-I - Configuration Chart

Build the microscope that suites your needs by choosing among the components



* Code M-1156 must be added only **once** for any motorized configuration

2 OPTIKA B-1000METBF - Brightfield Metallurgical Microscope

The modular OPTIKA B-1000METBF offers superior quality **brightfield incident light**, helping you working in a comfortable way during extended periods of use and performing reliable, accurate and rapid diagnosis benefiting from modularity, which gives the chance to create customized configurations tailored on customer needs. Versatile, robust, durable and sturdy, B-1000 offers premium quality optics, the state-of-the-art, exclusive **X-LED[®]** (8 W) transmitted illumination (Koehler system). The incident light relies on an incredibly bright 18 W LED illumination, designed by OPTIKA. B-1000 gives multiple options as manual or motorized configuration.



B-1000METBF - Configuration Chart

Build the microscope that suites your needs by choosing among the components

M-781
PL10x/22 eyepiece, high eyepoint,
with micrometric scale (10mm/100um)
& rubber cup (retractable)



M-1001
PL10x/22 eyepieces (pair),
high eyepoint, with rubber cup
(retractable)



M-1003
PL15x/16 eyepieces (pair),
high eyepoint



M-1011
Trinocular head, three positions
(100/0, 50/50, 0/100)



M-1012
Binocular ERGO head



M-1039
Metallurgical attachment, 18 W LED



M-1021M
Main body with focus system
and X-LED[®] illumination,
for metallurgical model



M-1021M+M-1156*+M-1149
Main body with motorized focus system
and X-LED[®] illumination,
for metallurgical model



M-1022M
Main body with focus system,
for metallurgical model with
incident light only



M-1022M+M-1156*+M-1149
Main body with motorized focus
system, for metallurgical model with
incident light only



M-1042
Sextuple reversed nosepiece,
for RMS objectives with DIC slot



M-1043+M-1156*
Sextuple motorized reversed nosepiece,
for RMS objectives with DIC slot



IOS LWD W-PLAN MET



M-1099 2.5x

IOS LWD U-PLAN MET



M-1100 5x
M-1101 10x
M-1102 20x
M-1103 50x
M-1104 100x

IOS LWD U-PLAN F MET

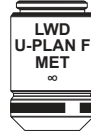

M-1171 5x
M-1172 10x
M-1173 20x
M-1174 50x
M-1175 100x

M-1148
Mechanical stage with glass,
for metallurgical model



M-1147+M-1156*
Motorized mechanical stage



M-1154
0.70 N.A. swing-out MET condenser



* Code M-1156 must be added only **once** for any motorized configuration

B-1000METDK - Darkfield Metallurgical Microscope

The modular OPTIKA B-1000METDK offers superior quality **brightfield and darkfield incident light**, helping you working in a comfortable way during extended periods of use and performing reliable, accurate and rapid diagnosis benefiting from modularity, which gives the chance to create customized configurations tailored on customer needs. Versatile, robust, durable and sturdy, B-1000 offers premium quality optics, the state-of-the-art, exclusive **X-LED³** (8 W) transmitted illumination (Koehler system). The incident light relies on an incredibly bright 18 W LED illumination, designed by OPTIKA. B-1000 gives multiple options as manual or motorized configuration.



22



B-1000METDK - Configuration Chart

Build the microscope that suites your needs by choosing among the components

M-781
PL10x/22 eyepiece, high eyepoint,
with micrometric scale (10mm/100um)
& rubber cup (retractable)



M-1001
PL10x/22 eyepieces (pair),
high eyepoint, with rubber cup
(retractable)



M-1003
PL15x/16 eyepieces (pair),
high eyepoint



M-1011
Trinocular head, three positions
(100/0, 50/50, 0/100)



M-1012
Binocular ERGO head



M-1039MD
Metallurgical attachment 18 W LED
(Built-in MET nosepiece with 6-positions)



M-1021MD
Main body with focus system
and X-LED8 illumination, for
brightfield/darkfield metallurgical B-1000



M-1021MD+M-1156*+M-1149
Main body with motorized focus system
and X-LED8 illumination, for
brightfield/darkfield metallurgical B-1000



M-1022MD
Main body with focus system
(incident light only), for
brightfield/darkfield metallurgical B-1000



M-1022MD+M-1156*+M-1149
Main body with motorized focus system
(incident light only), for
brightfield/darkfield metallurgical B-1000



IOS LWD W-PLAN MET



M-1099 2.5x

IOS LWD U-PLAN MET



M-1100 5x
M-1101 10x
M-1102 20x
M-1103 50x
M-1104 100x

IOS LWD U-PLAN F MET



M-1171 5x
M-1172 10x
M-1173 20x
M-1174 50x
M-1175 100x

IOS LWD U-PLAN MET BD



M-1094 5x
M-1095 10x
M-1096 20x
M-1097 50x
M-1098 100x

IOS LWD U-PLAN F MET BD

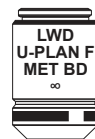

M-1180 5x
M-1181 10x
M-1182 20x
M-1183 50x
M-1184 100x

M-1148
Mechanical stage with glass,
for metallurgical model



M-1147+M-1156*
Motorized mechanical stage



M-1154
0.70 N.A. swing-out MET condenser



* Code M-1156 must be added only **once** for any motorized configuration

② B-1000 Multi-Head - Discussion Microscopes

The modular OPTIKA B-1000 helps you working in a comfortable way during extended periods of use and let you perform reliable, accurate and rapid diagnosis benefiting from modularity, which gives the chance to create customized configurations tailored on customer needs.

Versatile, robust, durable and sturdy, B-1000 offers premium quality optics (including Semi-Apo objectives), the state-of-the-art, exclusive **X-LED** illumination system, designed by OPTIKA and the Koehler diaphragm. B-1000 gives multiple options as manual or motorized configuration, with a variety of objectives, stages and condensers. Ideal for discussion groups and teaching purpose for multiple observers, up to ten users simultaneously.

A three-color LED pointer facilitates the indication and identification of the object observed (except the model B-1000Ti-10).



B-1000Ti-2 - multi-head microscope for 2 users

B-1000Ti-3 - multi-head microscope for 3 users

B-1000Ti-5 - multi-head microscope for 5 users

B-1000Ti-10 - multi-head microscope for 10 users



B-1000 Multi-Head - Configuration Chart

Build the microscope that suites your needs by choosing among the components

M-781
PL10x/22 eyepiece, high eyepoint, with micrometric scale (10mm/100um) & rubber cup (retractable)



M-1001
PL10x/22 eyepieces (pair), high eyepoint, with rubber cup (retractable)

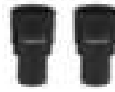

M-1003
PL15x/16 eyepieces (pair), high eyepoint



M-1011
Trinocular head, three positions (100/0, 50/50, 0/100)



M-1012
Binocular ERGO head



- M-1159** - Multi-head attachment, 1 extra head (face-to-face)
- M-1160** - Multi-head attachment, 1 extra head
- M-1161** - Multi-head attachment, 2 extra head
- M-1162** - Multi-head attachment, 4 extra head
- M-1163** - Multi-head attachment, 9 extra head

M-1021B
Main body with focus system and X-LED[®] illumination, for general purposes



M-1021B+M-1156*+M-1149
Main body with motorized system and X-LED[®] illumination, for general purposes



M-1042
Sextuple reversed nosepiece, for RMS objectives with DIC slot



M-1043+M-1156*
Sextuple motorized reversed nosepiece, for RMS objectives with DIC slot



IOS W-PLAN PH



- M-1120.N** 10x
- M-1121.N** 20x
- M-1122.N** 40x
- M-1123.N** 100x

IOS W-PLAN



- M-1049** 2x
- M-1125** 4x
- M-1126** 10x
- M-1127** 20x
- M-1128** 40x
- M-1129** 60x
- M-1130** 100x

IOS W-PLAN F



- M-1060** 4x
- M-1061** 10x
- M-1062** 20x
- M-1063** 40x
- M-1064** 100x

IOS U-PLAN F



- M-1075** 4x
- M-1076** 10x
- M-1077** 20x
- M-1078** 40x
- M-1079** 100x

M-1140
Standard mechanical stage



M-1141
Rackless mechanical stage



M-1143
MPC (Mineral Solid Surface) rackless mechanical stage



M-1147+M-1156*
Motorized mechanical stage



M-1144
Heating stage, with digital temperature controller



M-1150
0.90 N.A. swing-out condenser



M-1152.N
Phase contrast condenser 10x, 20x, 40x, 100x, BF, DF



M-1124
Phase contrast condenser with insert slide 10x-40x



M-1151
1.2 N.A. swing-out condenser



M-1155
0.9/0.25 N.A. swing-out condenser (to be used with objective M-1049)



M-618
Darkfield condenser for dry objectives



M-977
Green filter, 45mm



* Code M-1156 must be added only **once** for any motorized configuration

B-810/B-1000 - Accessories

Eyecups & Eyepieces

M-690 Eyecups (pair)

Condensers & Filters

M-613 Polarizing set (filters only) (except for B-1000FL-LED, B-1000MET, B-1000POL, and B-1000POL-I)
 M-615 Lambda filter for polarizing set (except for B-1000FL-LED, B-1000MET, B-1000POL, and B-1000POL-I)
 M-617.1NO Phase contrast set with IOS W-PLAN objective 40x (only for B-810)
 M-617.1N Phase contrast set with IOS W-PLAN objective 40x (only for B-1000)
 M-975 Blue filter, 45mm diameter (except for B-1000MET)
 M-977 Green filter, 45mm diameter (except for B-1000MET)
 M-979 Yellow filter, 45mm diameter (except for B-1000MET)
 M-989 Frosted glass filter, 45mm diameter (except for B-1000MET)
 M-1164 Empty fluorescence filterblock (only for B-1000FL-HBO)
 M-1165 Fluorescence filter set V (filterblock included) (only for B-1000FL-HBO)
 M-1166 Fluorescence filter set UV-DAPI (filterblock included) (only for B-1000FL-HBO)
 M-1220 Blue LED Fluorescence Cube (LED+Filterset), (only for B-1000LD4)
 M-1220.1 Blue (pass band) LED Fluorescence Cube (LED+Filterset), (only for B-1000LD4)
 M-1221 Green LED Fluorescence Cube (LED+Filterset), (only for B-1000LD4)
 M-1221.1 Green (pass band) LED Fluorescence Cube (LED+Filterset), (only for B-1000LD4)
 M-1222 Violet LED Fluorescence Cube (LED+Filterset), (only for B-1000LD4)
 M-1223 UV LED Fluorescence Cube (LED+Filterset), (only for B-1000LD4)
 M-1223.1 UV (pass band) LED Fluorescence Cube (LED+Filterset), (only for B-1000LD4)
 M-1224 Red 1 LED Fluorescence Cube (LED+Filterset), (only for B-1000LD4) *
 M-1225 Red 2 LED Fluorescence Cube (LED+Filterset), (only for B-1000LD4) *
 M-1226 Deep Red LED Fluorescence Cube (LED+Filterset), (only for B-1000LD4) *
 M-1227 Far Red LED Fluorescence Cube (LED+Filterset), (only for B-1000LD4) *
 M-1228 Amber LED Fluorescence Cube (LED+Filterset), (only for B-1000LD4)
 M-ND25 Neutral density filter, 25% transmission (only for B-1000FL-HBO)

Camera Adapters

M-113.1 Ring adapter, 30mm (for monocular and binocular microscopes)
 M-115 0.35x C-Mount projection lens
 M-114 0.5x C-Mount projection lens
 M-118 0.75x C-Mount projection lens
 M-173 C-Mount projection lens for APS-C/full frame reflex cameras (trino)
 M-620 0.35x focusable C-Mount adapter (biological microscopes)
 M-620.1 0.5x focusable C-Mount adapter (biological microscopes)
 M-620.2 0.65x focusable C-Mount adapter (biological microscopes)
 M-620.3 1x focusable C-Mount adapter (biological & stereomicroscopes)
 M-699 Universal adapter for C-Mount projection lens (trino)

Miscellaneous

15008 Immersion oil, 10ml
 15009 Immersion oil, 100ml
 15104 Cleaning kit
 AA-02 HSE-NPL Mark II phase contrast test slide, with certification (only for B-810 & B-1000PH)
 DC-005 TNT dust cover, extra large, 820(l)x550(h) mm
 M-005 Micrometric slide, 26x76mm, with 2 scales (1mm/100 & 10mm/100)
 M-151 HBO 100W high-pressure mercury bulb for fluorescence
 M-151.1 HBO 100W high-pressure mercury bulb for fluorescence (OSRAM)
 VP-1000 IQ/OQ/PQ manual for B-1000 series (Brightfield)
 VP-1000MET IQ/OQ/PQ manual for B-1000 series (Metallographic)
 VP-1000POL IQ/OQ/PQ manual for B-1000 series (Polarizing)
 VP-810 IQ/OQ/PQ manual for B-810 series
 VP-1000PH IQ/OQ/PQ manual for B-1000 series (Phase Contrast)
 VP-1000FL IQ/OQ/PQ manual for B-1000 series (Fluorescence)
 AB-030 Antibacterial surface treatment, only for newly purchased microscope

15104 - Cleaning kit

It cleans glass quickly and effectively, without leaving residue or odor. Ideal for precision lens or prism cleaning.



How to connect the cameras to our microscopes.

Please refer to the Adapter reference list on Digital section.

* If the use of a camera is needed, when used for red emission fluorescence wavelengths above 650nm, please order it by specifying with "AR GLASS"

v 7.5 - OPTIKA reserves the right to make corrections, modifications, enhancements, improvements and other changes to its products at any time without notice.

Headquarters and Manufacturing Facilities

OPTIKA® S.r.l. Via Rigla, 30 - 24010 Ponteranica (BG) - ITALY - Tel.: +39 035.571.392 - info@optikamicroscopes.com

Optika Sales branches

OPTIKA® Spain spain@optikamicroscopes.com
OPTIKA® China china@optikamicroscopes.com
OPTIKA® India india@optikamicroscopes.com

OPTIKA® North America namerica@optikamicroscopes.com
OPTIKA® Central America camerica@optikamicroscopes.com
OPTIKA® Africa africa@optikamicroscopes.com

OPTIKA[®]
M I C R O S C O P E S
I T A L Y

IM-300 Series



Routine Lab Inverted Microscopes

Your Preferred Inverted Microscope for Routine

ROUTINE IN UNIVERSITIES, LABS & INDUSTRIES

- » Wide range to fulfill specific lab requirements
- » Valuable solutions for life and material sciences
- » Compliant with several observation methods

AN AFFORDABLE PARTNER WITH HIGH-END FEATURES

- » IOS LWD W-PLAN objectives for flat images on 22 mm FN
- » Fast, efficient investigation with no particular sample prep
- » Trinocular port with beam splitter for most light-demanding needs



Optically Impressive

MAINTAINING GOOD EYESIGHT

- » 10x/22 eyepieces for large specimen view
- » Comfortable rubber cup to get rid of annoying external light
- » High eye-point for glasses wearers, diopter adjustment (left eyepiece)

IM-300 & IOS W-PLAN: THE PERFECT COMBINATION

- » IOS Infinity corrected optical system
- » Full planarity optics on 22 mm (W-PLAN) according to ISO 19012-1
- » High-grade Semi-Apo lens available ideal for fluorescence



An Extensive Range of Different Configurations

OBSERVE EVEN THE MOST COMPLEX SAMPLES

- » Phase contrast objective for transparent sample examination
- » LED and HBO fluorescence available for specific purposes
- » High quality no cover glass objectives for material science

CONCEPTUAL INNOVATION IN LED FLUORESCENCE

- » Choose the lowest operational cost, LED lifetime of 65,000 hours
- » Immediate operation, eliminating warm-up/cool-down times
- » Forget about lamp centering, adjustment and maintenance

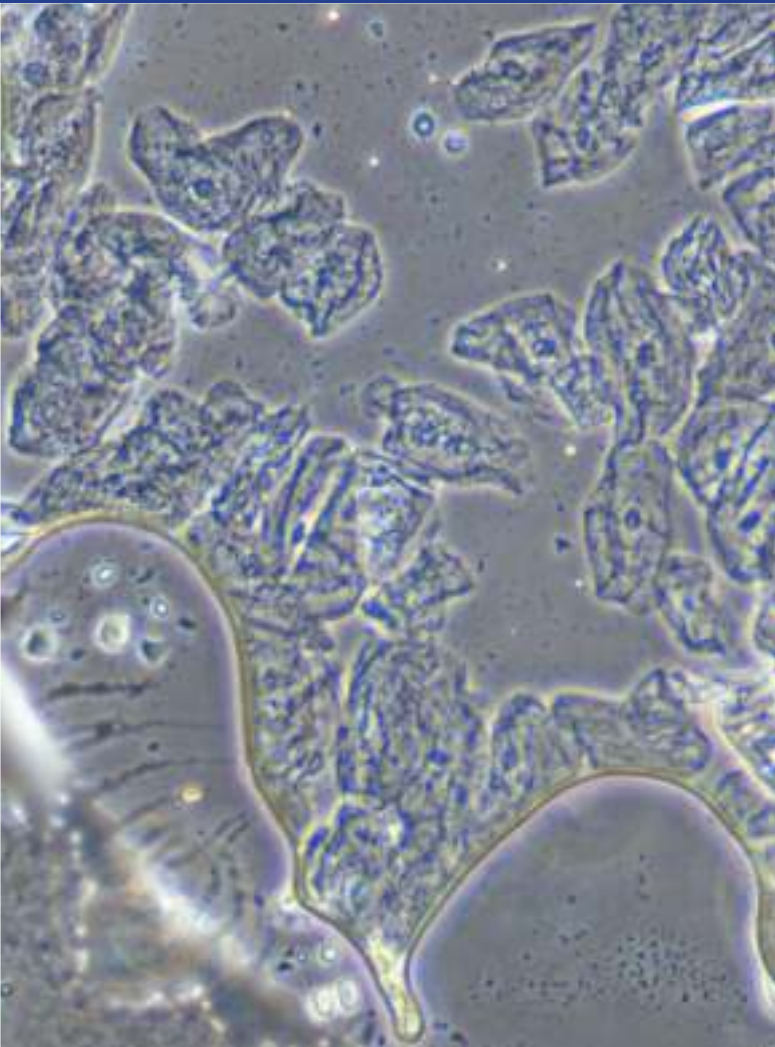

RPC - Relief Phase Contrast

RPC system is designed to increase visibility and contrast in unstained and living material by detecting optical gradients (or slopes) and converting them into variations of light intensity. Typical applications are transparent specimens, bacteria, tissue culture work, spermatozoa, cells in glass containers, protozoa, mites, fibers, etc.

When observed under modulation contrast optics (RPC), transparent objects that are essentially not visible in ordinary brightfield microscopy take on an apparent three-dimensional appearance dictated by phase gradients in the specimen. There are also no halos exhibited in the image, unlike the images produced with phase contrast optics.

RPC is recommended over **DIC** technique in case of specimens like crystals (with effects upon polarized light), or contained in specimen carriers such as plastic culture vessels, Petri dishes, etc.

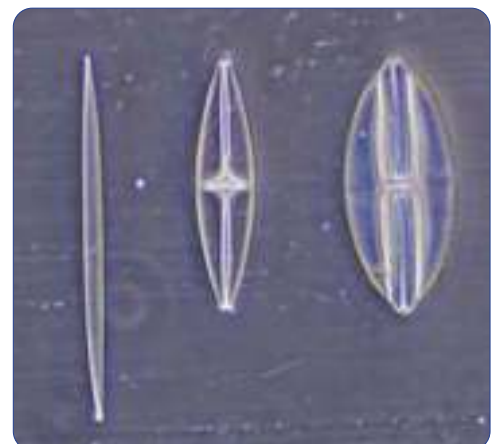

X-LED⁸ - Only Available at OPTIKA

STATE-OF-THE-ART ILLUMINATION SYSTEM

- » Uncomparable light intensity, exclusive lens & collector design
- » Constant pure-white color temperature at all intensity levels
- » Unmatched color fidelity, uniformity and brightness

CUT ELECTRICITY BILLS BY 90%

- » Money & energy saving, 8 W
- » More efficient brightness than a 100 W halogen lamp
- » LED long lifetime (65,000 hours = 22 years at 8 hours/day usage)



Go Digital - Vivid Colors & Contrast For Stunning Images

STAY CONNECTED WITH YOUR SPECIMEN, EASILY

- » Trinocular port to be always updated with the latest technology cameras, even in the future
- » Wide range of cameras matching all the needs, including the more specific ones
- » Modern C-mount focusable professional adapters for all kinds of cameras

PROFESSIONAL IMAGE ANALYSIS

- » Multi-language software for live-view, picture and video in different file formats
- » Advanced functions for pictures processing (EDF, stitching, multi-fluorescence combine)
- » Powerful tools to perform measurements and generate custom reports

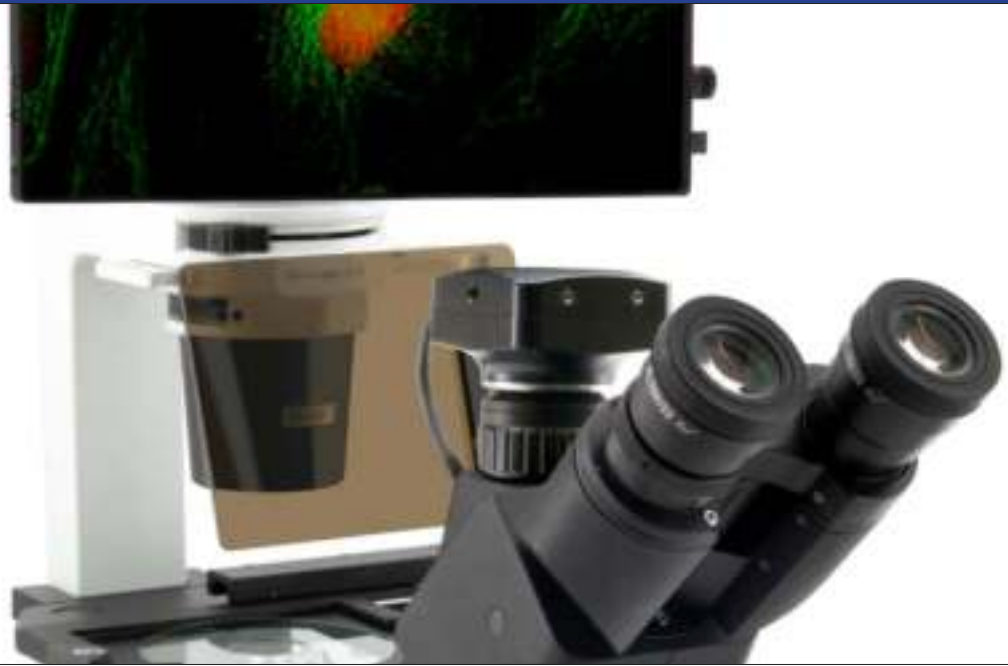

Multiple Observation Methods

BRIGHTFIELD

MATERIAL SCIENCE

RPC

RELIEF PHASE CONTRAST

PHASE CONTRAST

FLUORESCENCE

IM-300 Series

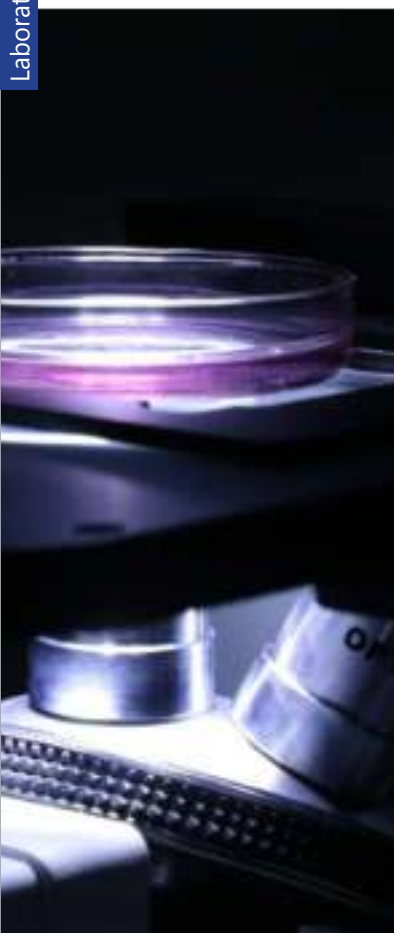

Inverted microscopes are useful for observing living cells or organisms at the bottom of a large container (e.g., a tissue culture flask) under more natural conditions than on a glass slide, as it occurs with a conventional microscope. IM-300 Series is engineered and designed to be your ideal solution for fast and reliable routine inspections, with the exclusive, state-of-the-art X-LED[®] illumination system. A particularly simple and ingenious optical design allows stable alignments and smooth and accurate movements. OPTIKA provides different configurations, including the innovative LED fluorescence technology for a new, enhanced experience.

X-LED[®] Exclusive Lighting Source

Special technology able to double the light intensity for incomparable performance, ensuring constant pure-white colour temperature (6,300K colour temperature).

Relevant money and energy saving thanks to the incredibly low energy consumptions which allows you to cut the electricity bills by 90%!

The electric consumption (8 W only) proves the high efficiency of this system: incredibly high light intensity combined with low consumption.

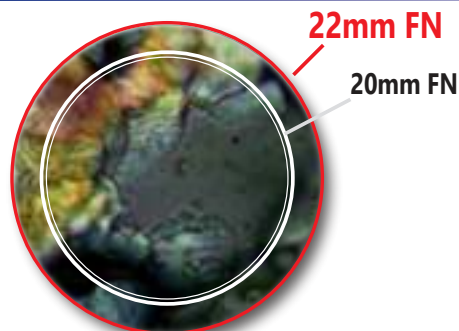

Large Specimen View (22 mm Field Number)

The **F.O.V.** (field of view) is based on a comfortable diameter of 22 mm.

This means that an extra wide area of the sample can be inspected and allows a natural and easy view, particularly needed in a laboratory environment.

In fluorescence we can offer several options.

According to your application and to the fluorochromes you are using, we can help you to identify the best light source.



Traditional, HBO Fluorescence

- » The most used and diffused method, worldwide
- » Wide spectrum range for future upgrades
- » HBO Fluorescence power supply



Innovative, LED Fluorescence

- » Recommended for routine applications
- » Cost-effective, money saving technology
 - » Ready for immediate operation
 - » Eliminate warm-up/cool-down times
 - » Forget lamp replacement & centering

Routine Lab Inverted Microscopes

Get the most out of our accessories



DESIGNED TO FACILITATE YOUR DAILY ROUTINE

- » Removable condenser to increase the working distance
- » Mechanical stage and side extensions for great comfort (as optional)
- » Different inserts available according to the container used (as optional)



M-793.1
Holder for Petri 38mm diameter
(M-793.2 needed)



M-793.2
Holder for Terasaki and Petri 65mm diameter



M-793.3
Holder for slides and Petri 54mm diameter



M-793.4
Holder for 2+2 slides



M-793.5
Holder for metallurgical samples



M-793.6
Holder for Utermohl-Chamber (M-793.3 needed)



M-793.7
Load bearing side extension



M-792
Mechanical stage for IM-300
(except IM-300LD2 and IM-300LD4)



M-792.2
Mechanical stage for IM-300
(IM-300LD2 only)

IM-300 - Brightfield & Phase Contrast Microscope



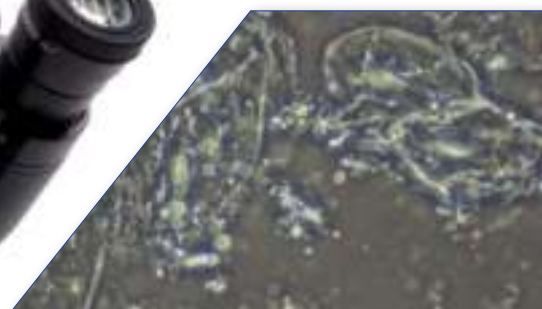



IM-300 looks at the challenge of the future with confidence, offering first-class optical quality and mechanical versatility, to extend its use with several accessories. Ensuring top-level brightfield and phase contrast observation, as it comes with a set of 3 IOS LWD W-PLAN PH objectives (10x, 20x and 40x). The high-efficiency **X-LED[®]** makes it reliable for all transmitted light observations. For a more complete solution, choose among the several accessories available (objectives, mechanical stage, side extensions, holders and stage inserts).



Part	Description
Observation mode:	Brightfield, phase contrast.
Head:	Trinocular (2-position 100/0, 50/50), 45° inclined.
Interpupillary distance:	Adjustable between 50 and 75 mm.
Diopter adjustment:	On the left eyepiece tube.
Eyepieces:	WF10x/22 mm, high eye-point and with rubber cups.
Nosepiece:	Quintuple revolving nosepiece, rotation on ball bearings.
Objectives:	IOS LWD W-PLAN PH 10x/0.25 IOS LWD W-PLAN PH 20x/0.40 IOS LWD W-PLAN PH 40x/0.65 All with anti-fungus treatment.

Part	Description
Specimen stage:	Fixed stage, 250x290 mm, with round glass and metal stage inserts for slides and 54mm dia. Petri dishes.
Focusing:	Coaxial coarse (adjustable tension) and fine focusing mechanism.
Condenser:	LWD pre-centered condenser, N.A. 0.30, W.D. 72 mm. With 4x/10x, 20x/40x phase contrast slider and brightfield. Supplied with blue and green filter.
Transmitted illumination:	X-LED [®] with white 8 W LED (6,300K) with brightness control. With aperture diaphragm. Multi-plug 100-240Vac/6Vdc external power supply.

IM-300D- Brightfield & Phase Contrast Microscope

-  15.6"
-  6 MP
-  22
- 
-  X-LED[®]
- 
- 
- 
- 
- 
- 

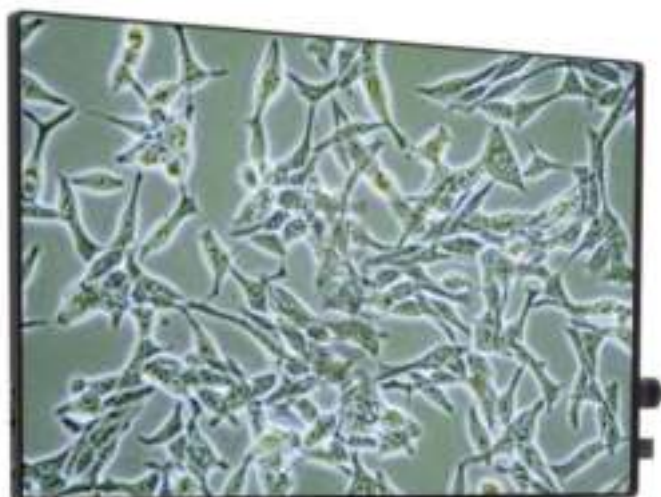

IM-300D looks at the challenge of the future with confidence, offering first-class optical quality and mechanical versatility, to extend its use with several accessories. Ensuring top-level brightfield and phase contrast observation, as it comes with a set of 3 IOS LWD W-PLAN PH objectives (10x, 20x and 40x). The high-efficiency **X-LED[®]** makes it reliable for all transmitted light observations. For a more complete solution, choose among the several accessories available (objectives, mechanical stage, side extensions, holders and stage inserts). This model is equipped with an Intel micro PC, a 15.6" 4K touch screen, 6Mpx high-sensitivity color camera, Optika ProView image analysis software.



Part	Description
Observation mode:	Brightfield, phase contrast.
Head:	Trinocular (2-position 100/0, 50/50), 45° inclined.
Interpupillary distance:	Adjustable between 50 and 75 mm.
Diopter adjustment:	On the left eyepiece tube.
Eyepieces:	WF10x/22 mm, high eye-point and with rubber cups.
Nosepiece:	Quintuple revolving nosepiece, rotation on ball bearings.
Objectives:	IOS LWD W-PLAN PH 10x/0.25 IOS LWD W-PLAN PH 20x/0.40 IOS LWD W-PLAN PH 40x/0.65 All with anti-fungus treatment.

Part	Description
Specimen stage:	Fixed stage, 250x290 mm, with round glass and metal stage inserts for slides and 54mm dia. Petri dishes.
Focusing:	Coaxial coarse (adjustable tension) and fine focusing mechanism.
Condenser:	LWD pre-centered condenser, N.A. 0.30, W.D. 72 mm. With 4x/10x, 20x/40x phase contrast slider and brightfield. Supplied with blue (LBD) and green filter.
Transmitted illumination:	X-LED [®] with white 8 W LED (6,300K) with brightness control. With aperture diaphragm. Multi-plug 100-240Vac/6Vdc external power supply.
Digital equipment:	Intel micro PC with Image analysis software for imaging. 15.6" 4K touch screen; 6MP high-sensitivity color camera.

2 IM-300F - HBO Fluorescence Microscope

Routine inverted fluorescence microscope for transmitted brightfield, phase contrast and fluorescence observations with IOS LWD W-PLAN objectives. The HBO fluorescence illuminator is combined with blue and green excitation filter set for the visualization of the following fluorochromes: Ethidium Bromide, Acridine Orange, Alexa Fluor 488, Fluo-4, FITC Plus, Spectrum Green, Ethidium Homodimer I, Propidium Iodide (PI) and Spectrum Gold. Transmitted light through the exclusive **X-LED[®]** to ensure great-looking, rich and high-quality specimen view.



Standard filtersets

Name	Excitation filter (nm)	Dichroic mirror cut-off (nm)	Emission filter (nm)
B (Blue)	465 – 495	505	515LP
G (Green)	527 – 553	565	575LP



Part	Description
Observation mode:	Brightfield, phase contrast, HBO fluorescence.
Epi-illumination and filter:	HBO 100 W high pressure mercury lamp. 3-position filter holder; blue & green included.
Head:	Trinocular (2-position 100/0, 0/100), 45° inclined.
Interpupillary distance:	Adjustable between 50 and 75 mm.
Diopter adjustment:	On the left eyepiece tube.
Eyepieces:	WF10x/22 mm, high eye-point and with rubber cups.
Nosepiece:	Quintuple revolving nosepiece, rotation on ball bearings.
Objectives:	IOS LWD W-PLAN PH 10x/0.25 IOS LWD W-PLAN PH 20x/0.40 IOS LWD W-PLAN PH 40x/0.65 All with anti-fungus treatment.

Part	Description
Specimen stage:	Fixed stage, 250x290 mm, with round glass and metal stage inserts for slides and 54mm dia. Petri dishes.
Focusing:	Coaxial coarse (adjustable tension) and fine focusing mechanism.
Condenser:	LWD pre-centered condenser, N.A. 0.30, W.D. 72 mm. With 4x/10x, 20x/40x phase contrast slider and brightfield. Supplied with blue (LBD) and green filter.
Transmitted illumination:	X-LED [®] with white 8 W LED (6,300K) with brightness control. With aperture diaphragm. Multi-plug 100-240Vac/6Vdc external power supply.

IM-300FL4 - HBO Fluorescence Microscope

Advanced inverted microscope for brightfield and fluorescence observations with Semi-Apo IOS LWD U-PLAN F objectives to enhance the visibility of the sample and increase the overall contrast. The HBO fluorescence illuminator provides an outstanding flexibility of use, standing the blue and green filter sets (supplied as standard) for Ethidium Bromide, Acridine Orange, Alexa Fluor 488, Fluo-4, FITC Plus, Spectrum Green, Ethidium Homodimer I, Propidium Iodide (PI) and Spectrum Gold, with additional filterset: Alexa Fluor 350, Aminocoumarin, Hoechst, DAPI, BFP (Blue Fluorescent Protein), Atto 390, Tetracycline, Pacific Orange and Spectrum Blue. Transmitted light through the exclusive **X-LED[®]** to ensure great-looking, rich and high-quality specimen view.



Standard filterset

Name	Excitation filter (nm)	Dichroic mirror cut-off (nm)	Emission filter (nm)
B Blue	465 - 495	505	515LP
G Green	527 - 553	565	575LP

Additional filterset (optional)

Name	Excitation filter (nm)	Dichroic mirror cut-off (nm)	Emission filter (nm)
V (Violet)	390 - 420	440	455LP
UV	325 - 375	415	435LP

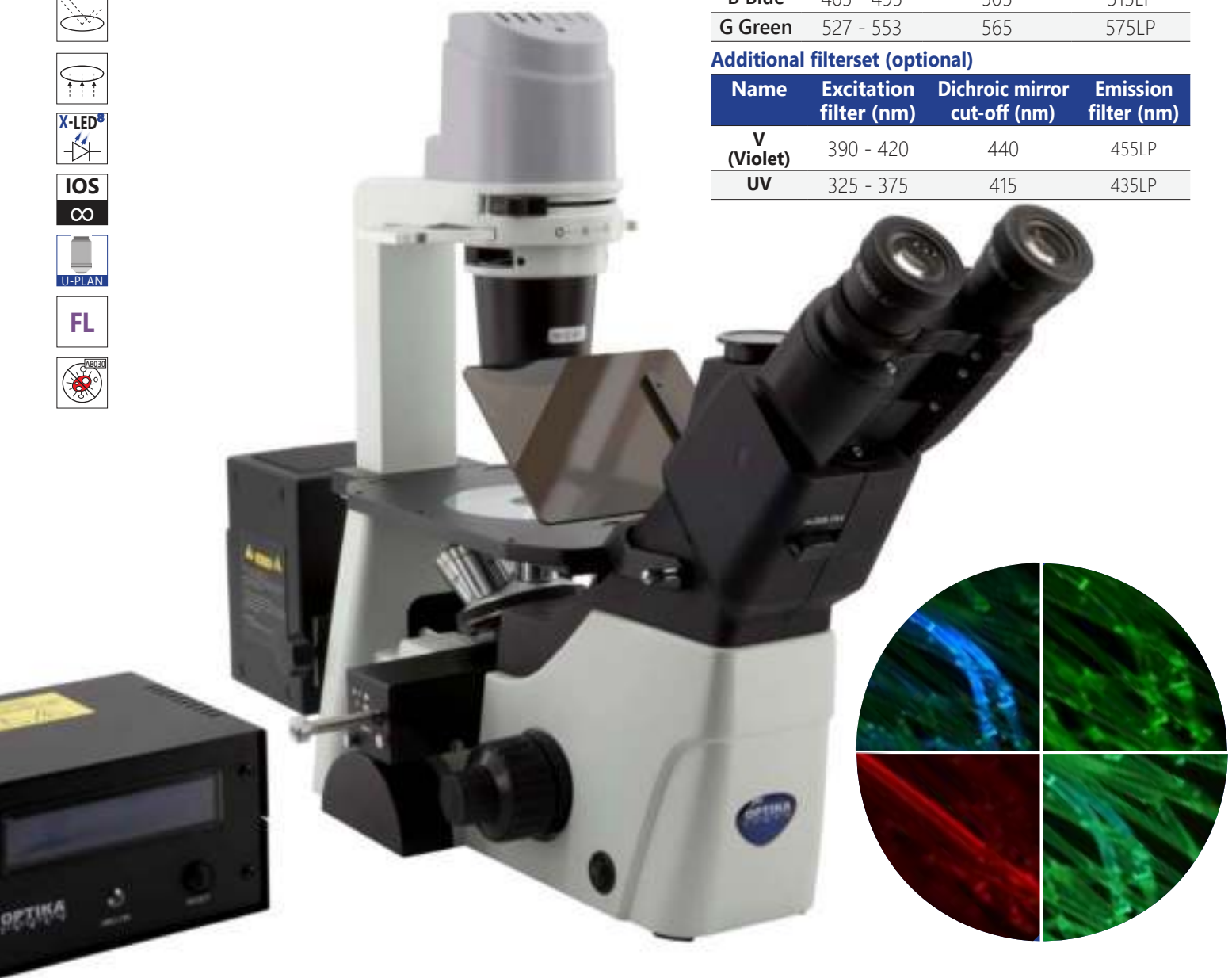

Part	Description
Observation mode:	Brightfield, HBO fluorescence.
Epi-illumination and filter:	HBO 100 W high pressure mercury lamp. 4-position filter holder; blue & green included.
Head:	Trinocular (2-position 100/0, 0/100), 45° inclined.
Interpupillary distance:	Adjustable between 50 and 75 mm.
Diopter adjustment:	On the left eyepiece tube.
Eyepieces:	WF10x/22 mm, high eye-point and with rubber cups.
Nosepiece:	Quintuple revolving nosepiece, rotation on ball bearings.
Objectives:	IOS LWD U-PLAN F 10x/0.30 IOS LWD U-PLAN F 20x/0.45 IOS LWD U-PLAN F 40x/0.65 All with anti-fungus treatment.

Part	Description
Specimen stage:	Fixed stage, 250x290 mm, with round glass and metal stage inserts for slides and 54mm dia. Petri dishes.
Focusing:	Coaxial coarse (adjustable tension) and fine focusing mechanism.
Condenser:	LWD pre-centered condenser, N.A. 0.30, W.D. 72 mm. Supplied with blue (LBD) filter.
Transmitted illumination:	X-LED [®] with white 8 W LED (6,300K) with brightness control. With aperture diaphragm. Multi-plug 100-240Vac/6Vdc external power supply.

IM-300LD2 - LED Fluorescence Microscope

Routine inverted fluorescence microscope for transmitted brightfield, phase contrast and fluorescence observations with IOS LWD W-PLAN PH objectives.

The LED fluorescence illuminators are combined with blue and green excitation filter set for the visualization of the following fluorochromes: GFP, Alexa Fluor 488, Calcein, SYBR Green, FITC, Fluo-4, MitoTracker Green, Spectrum Gold, Propidium Iodide, Ethidium Homodimer I. LED fluorescence ensures unparalleled convenience eliminating warm-up/cool-down times and all the inconveniences related lamp replacement and adjustment. Transmitted light through the exclusive **X-LED[®]** to ensure great-looking, rich and high-quality specimen view.



A new milestone achieved in Fluorescence Microscopy

- » 10% higher light intensity than HBO
- » 35% higher light intensity than Metal-Halide
- » Adjustable light intensity
- » The selection of filtersets automatically involves the switching on of the corresponding LEDs
- » Recommended for routine applications
- » Cost-effective, money saving technology
- » Ready for immediate operation
- » Eliminate warm-up/cool-down times
- » Forget lamp replacement & centering

LED Fluorescence Cubes (LED + Filterset) included

Name	LED emission (nm)	Excitation filter (nm)	Dichroic mirror cut-off (nm)	Emission filter (nm)
Blue	460	455 - 495	500	510LP
Green	523	510 - 550	570	575LP

Part	Description
Observation mode:	Brightfield, phase contrast, LED fluorescence.
Epi-illumination and filter:	High-power LED with brightness control. 3-position filter holder; blue and green filtersets included.
Head:	Trinocular (2-position 100/0, 50/50), 45° inclined.
Interpupillary distance:	Adjustable between 50 and 75 mm.
Diopter adjustment:	On the left eyepiece tube.
Eyepieces:	WF10x/22 mm, high eye-point and with rubber cups.
Nosepiece:	Quintuple revolving nosepiece, rotation on ball bearings.
Objectives:	IOS LWD W-PLAN PH 10x/0.25 IOS LWD W-PLAN PH 20x/0.40 IOS LWD W-PLAN PH 40x/0.65 All with anti-fungus treatment.

Part	Description
Specimen stage:	Fixed stage, 250x290 mm, with round glass and metal stage inserts for slides and 54mm dia. Petri dishes.
Focusing:	Coaxial coarse (adjustable tension) and fine focusing mechanism.
Condenser:	LWD pre-centered condenser, N.A. 0.30, W.D. 72 mm. With 4x/10x, 20x/40x phase contrast slider and brightfield.
Transmitted illumination:	X-LED [®] with white 8 W LED (6,300K) with brightness control. With aperture diaphragm. 100-240Vac/12Vdc external power supply.

IM-300LD4 - LED Fluorescence Microscope

Advanced fluorescence inverted microscope for transmitted brightfield and fluorescence observations with IOS LWD U-PLAN F objectives. The extremely powerful LED Fluorescence Illuminators are combined with corresponding excitation filter sets for the visualization of most fluorochromes. LED fluorescence ensures unparalleled convenience eliminating warm-up/cool-down times and all the inconveniences related lamp replacement and adjustment. Transmitted light through the exclusive **X-LED[®]** to ensure great-looking, rich and high-quality specimen view.



A new milestone achieved in Fluorescence Microscopy

- » Full-modular Fluorescence System
- » Interchangeable LED-Filtersets
- » 4 LED-Filtersets slots
- » 10% higher light intensity than HBO
- » 35% higher light intensity than Metal-Halide
- » Adjustable light intensity
- » The selection of filtersets automatically involves the switching on of the corresponding LEDs
- » Recommended for research applications
- » Cost-effective, money saving technology
- » Ready for immediate operation
- » Eliminate warm-up/cool-down times
- » Forget lamp replacement & centering

LED Fluorescence Cubes available (LED + Filterset)

Name	LED emission (nm)	Excitation filter (nm)	Dichroic mirror cut-off (nm)	Emission filter (nm)
M-1230 - Blue	460	455 - 495	500	510LP
M-1230.1 - Blue (pass band)	460	455 - 495	500	518-542
M-1231 - Green	523	510 - 550	570	575LP
M-1231.1 - Green (pass band)	523	510 - 550	570	585-625
M-1232 - Violet	405	390 - 420	440	450LP
M-1233 - UV	365	325 - 375	415	435LP
M-1233.1 - UV (pass band)	365	340 - 390	405	420-470
M-1234 - Red 1 *	623	590 - 650	660	665LP
M-1235 - Red 2 *	623	595 - 645	655	665 - 715
M-1236 - Deep Red *	660	623 - 678	685	690 - 750
M-1237 - Far Red *	740	720 - 760	770	780LP
M-1238 - Amber	590	582 - 603	610	615 - 645

* If the use of a camera is needed, when used for red emission fluorescence wavelengths above 650nm, please order OPTIKA camera code C-P6AR.

Part	Description
Observation mode:	Brightfield, LED fluorescence.
Epi-illumination and filter:	High -Power LED with brightness control. 4-position filter holder; none included.
Head:	Trinocular (2-position 100/0, 50/50), 45° inclined.
Interpupillary distance:	Adjustable between 50 and 75 mm.
Diopter adjustment:	On the left eyepiece tube.
Eyepieces:	WF10x/22 mm, high eye-point and with rubber cups.
Nosepiece:	Quintuple revolving nosepiece, rotation on ball bearings.
Objectives:	IOS LWD U-PLAN F 10x/0.30 IOS LWD U-PLAN F 20x/0.45 IOS LWD U-PLAN F 40x/0.65 All with anti-fungus treatment.

Part	Description
Specimen stage:	Mechanical stage, 250x290 mm, with round glass and metal stage, inserts for slides and 54mm dia. Petri dishes.
Focusing:	Coaxial coarse (adjustable tension) and fine focusing mechanism.
Condenser:	LWD pre-centered condenser, N.A. 0.30, W.D. 72 mm. Supplied with blue (LBD) filter.
Transmitted illumination:	X-LED [®] with white 8 W LED (6,300K) with brightness control. With aperture diaphragm. Multi-plug 100-240Vac/12Vdc external power supply.

IM-300LD4D - LED Fluorescence Microscope

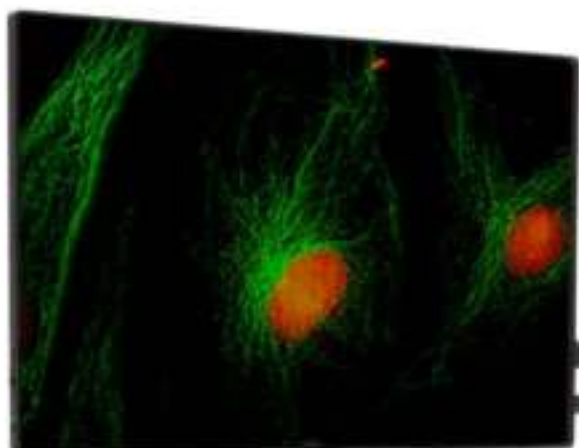

Advanced fluorescence inverted microscope for transmitted brightfield and fluorescence observations with IOS LWD U-PLAN F objectives. The extremely powerful LED Fluorescence Illuminators are combined with corresponding excitation filter sets for the visualization of most fluorochromes. LED fluorescence ensures unparalleled convenience eliminating warm-up/cool-down times and all the inconveniences related lamp replacement and adjustment. Transmitted light through the exclusive **X-LED[®]** to ensure great-looking, rich and high-quality specimen view. This model is equipped with an Intel micro PC, a 15.6" 4K touch screen, 6Mpx high-sensitivity color camera and Optika ProView image analysis software for fluorescence.

A new milestone achieved in Fluorescence Microscopy

- » Full-modular Fluorescence System
- » Interchangeable LED-Filtersets
- » 4 LED-Filtersets slots
- » 10% higher light intensity than HBO
- » 35% higher light intensity than Metal-Halide
- » Adjustable light intensity
- » The selection of filtersets automatically involves the switching on of the corresponding LEDs
- » Recommended for research applications
- » Cost-effective, money saving technology
- » Ready for immediate operation
- » Eliminate warm-up/cool-down times
- » Forget lamp replacement & centering

Name	LED emission (nm)	Excitation filter (nm)	Dichroic mirror cut-off (nm)	Emission filter (nm)
M-1230 - Blue	460	455 - 495	500	510LP
M-1230.1 - Blue (pass band)	460	455 - 495	500	518-542
M-1231 - Green	523	510 - 550	570	575LP
M-1231.1 - Green (pass band)	523	510 - 550	570	585-625
M-1232 - Violet	405	390 - 420	440	450LP
M-1233 - UV	365	325 - 375	415	435LP
M-1233.1 - UV (pass band)	365	340 - 390	405	420-470
M-1234 - Red 1	623	590 - 650	660	665LP
M-1235 - Red 2	623	595 - 645	655	665 - 715
M-1236 - Deep Red	660	623 - 678	685	690 - 750
M-1237 - Far Red	740	720 - 760	770	780LP
M-1238 - Amber	590	582 - 603	610	615 - 645

Part	Description
Observation mode:	Brightfield, LED fluorescence.
Epi-illumination and filter:	High -Power LED with brightness control. 4-position filter holder; none included.
Head:	Trinocular (2-position 100/0, 50/50), 45° inclined.
Interpupillary distance:	Adjustable between 50 and 75 mm.
Diopter adjustment:	On the left eyepiece tube.
Eyepieces:	WF10x/22 mm, high eye-point and with rubber cups.
Nosepiece:	Quintuple revolving nosepiece, rotation on ball bearings.
Objectives:	IOS LWD U-PLAN F 10x/0.30 IOS LWD U-PLAN F 20x/0.45 IOS LWD U-PLAN F 40x/0.65 All with anti-fungus treatment.

Part	Description
Specimen stage:	Mechanical stage, 250x290 mm, with round glass and metal stage inserts for slides and 54mm dia. Petri dishes.
Focusing:	Coaxial coarse (adjustable tension) and fine focusing mechanism.
Condenser:	LWD pre-centered condenser, N.A. 0.30, W.D. 72 mm. Supplied with blue (LBD) filter.
Transmitted illumination:	X-LED [®] with white 8 W LED (6,300K) with brightness control. With aperture diaphragm. Multi-plug 100-240Vac/12Vdc external power supply.
Digital equipment:	Intel micro PC with Image analysis software for Fluorescence. 15.6" 4K touch screen; 6MP IR sensitive high-sensitivity color camera.

IM-300METLD- Metallurgical Microscope

LED routine inverted microscope with IOS LWD U-PLAN MET objectives for material science and metallographic applications, combining a sturdy yet compact structure with dedicated components required in this field, like the NCG (no cover glass) objectives working without cover slide ideal for metallographic samples and other opaque specimens. A particularly simple and ingenious optical design allows stable alignments and smooth and accurate movements. This model is equipped with an 18W LED lighting system.

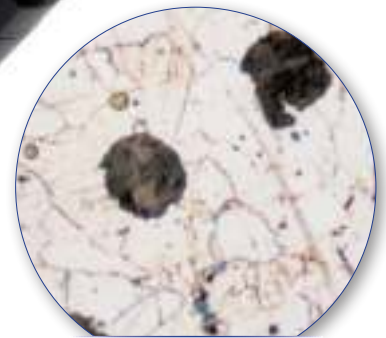

**CAST IRON
BRIGHTFIELD**



**CAST IRON
POLARIZED LIGHT**

Part	Description
Observation mode:	Brightfield, simple polarized light.
Epi-illumination and polarizing filters:	LED 18 W with brightness control. With centrable aperture and field diaphragms. With polarizer and 360° analyzer. Supplied with blue (LBD) filter.
Head:	Trinocular (2-position 100/0, 50/50), 45° inclined.
Interpupillary distance:	Adjustable between 50 and 75 mm.
Diopter adjustment:	On the left eyepiece tube.
Eyepieces:	WF10x/22 mm, high eye-point and with rubber cups.
Nosepiece:	Quintuple revolving nosepiece, rotation on ball bearings.

Part	Description
Objectives:	IOS LWD U-PLAN MET 5x/0.15 IOS LWD U-PLAN MET 10x/0.30 IOS LWD U-PLAN MET 20x/0.45 IOS LWD U-PLAN MET 50x/0.55 All with anti-fungus treatment.
Specimen stage:	Fixed stage, 250x160 mm, with round metal stage insert.
Focusing:	Coaxial coarse (adjustable tension) and fine focusing mechanism.

IM-300 Series - Comparison chart

Model	Type	Objectives	Condenser	Incident illumination	Fluorescence slider	Transmitted illumination	Digital equipment
IM-300	BF, PH	IOS LWD W-PLAN PH 10x, 20x, 40x	LWD, N.A. 0.30, iris diaphragm	-	-	8 W X-LED [®] , brightness control	-
IM-300D	BF, PH	IOS LWD W-PLAN PH 10x, 20x, 40x	LWD, N.A. 0.30, iris diaphragm	-	-	8 W X-LED [®] , brightness control	Intel micro PC 15.6" 4K touch screen; 6MP high-sensitivity color camera.
IM-300F	BF, FL, PH	IOS LWD W-PLAN PH 10x, 20, 40x	LWD, N.A. 0.30, iris diaphragm	FL HBO with blue and green filtersets	2-position +BF	8 W X-LED [®] , brightness control	-
IM-300FL4	BF, FL	IOS LWD U-PLAN F 10x, 20x, 40x	LWD, N.A. 0.30, iris diaphragm	FL HBO with blue and green filtersets	3-position +BF	8 W X-LED [®] , brightness control	-
IM-300LD2	BF, FL, PH	IOS LWD W-PLAN PH 10x, 20x, 40x	LWD, N.A. 0.30, iris diaphragm	FL LED with blue and green filtersets	2-position +BF	8 W X-LED [®] , brightness control	-
IM-300LD4	BF, FL	IOS LWD U-PLAN F 10x, 20x, 40x	LWD, N.A. 0.30, iris diaphragm	LED Fluorescence Cubes as optional	4-position	8 W X-LED [®] , brightness control	-
IM-300LD4D	BF, FL	IOS LWD U-PLAN F 10x, 20x, 40x	LWD, N.A. 0.30, iris diaphragm	LED Fluorescence Cubes as optional	2-position	8 W X-LED [®] , brightness control	Intel micro PC 15.6" 4K touch screen, 6MP IR sensitive high-sensitivity color camera.
IM-300METLD	BF, PO	IOS LWD U-PLAN MET 5x, 10x, 20x, 50x	-	LED 18 W, brightness control	-	-	-

IM-300 Series - Optical performance

IM-300 / IM-300LD2 / IM-300F

Eyepiece		10x (M-780)		
Field number (mm)	22			
Objective	N.A.	W.D. (mm)	Total magnification	Field of view (mm)
2x	0.08	19.40	20x	11
4x	0.13	10.40	40x	5.50
10x PH	0.25	7.30	100x	2.20
20x PH	0.40	6.80	200x	1.10
40x PH	0.60	3.00	400x	0.55
40x	0.60	3.00	400x	0.55
60x	0.70	1.70	600x	0.37

IM-300FL4 / IM-300LD4 / IM-300LD4D

Eyepiece		10x (M-780)		
Field number (mm)	22			
Objective	N.A.	W.D. (mm)	Total magnification	Field of view (mm)
4x	0.13	18.52	40x	5.50
10x	0.30	7.11	100x	2.20
20x	0.45	5.91	200x	1.10
40x	0.65	1.61	400x	0.55
60x	0.75	1.04	600x	0.37

IM-300METLD

Eyepiece		10x (M-780)			15x (M-601)	
Field number (mm)	22			16		
Objective	N.A.	W.D. (mm)	Total magnification	Field of view (mm)	Total magnification	Field of view (mm)
5x	0.15	10.80	50x	4.40	75x	3.20
10x	0.30	10	100x	2.20	150x	1.60
20x	0.45	4	200x	1.10	300x	0.80
50x	0.55	7.90	500x	0.44	750x	0.32
100x	0.80	2.10	1000x	0.22	1500x	0.16

IM-300 Series - Accessories

2

Laboratory

Eyecups & Eyepieces

- M-601 WF15x/16 eyepiece, high eyepoint (30mm Ø)
- M-780 PL10x/22 eyepiece, high eyepoint, rubber cup (30mm Ø)
- M-781 PL10x/22 micrometric eyepiece, high eyepoint, rubber cup (30mm Ø)

Objectives

IOS W-PLAN

- M-1049 IOS W-PLAN objective 2x/0.08
- M-782 IOS LWD W-PLAN objective 4x/0.13
- M-773 IOS LWD W-PLAN objective 40x/0.60
- M-786 IOS LWD W-PLAN objective 60x/0.70

IOS W-PLAN PH

- M-782.1 IOS LWD W-PLAN PH objective 4x/0.13
- M-783N IOS LWD W-PLAN PH objective 10x/0.25
- M-784N IOS LWD W-PLAN PH objective 20x/0.40
- M-785 IOS LWD W-PLAN PH objective 40x/0.65

IOS U-PLAN F

- M-800 IOS LWD U-PLAN F objective 4x/0.13
- M-801 IOS LWD U-PLAN F objective 10x/0.30
- M-802 IOS LWD U-PLAN F objective 20x/0.45
- M-803 IOS LWD U-PLAN F objective 40x/0.65
- M-804 IOS LWD U-PLAN F objective 60x/0.75

IOS U-PLAN F PH

- M-1177 IOS LWD U-PLAN F PH objective 20x/0.45
- M-1178 IOS LWD U-PLAN F PH objective 40x/0.65

IOS U-PLAN MET

- M-1100 IOS LWD U-PLAN MET objective 5x/0.15
- M-1101 IOS LWD U-PLAN MET objective 10x/0.30
- M-1102 IOS LWD U-PLAN MET objective 20x/0.45
- M-1103 IOS LWD U-PLAN MET objective 50x/0.55
- M-1104 IOS LWD U-PLAN MET objective 100x/0.80 (dry)

IOS LWD U-PLAN RPC

- M-861 IOS LWD U-PLAN RPC Objective 4x/0.13
- M-862 IOS LWD U-PLAN RPC Objective 10x/0.25
- M-863 IOS LWD U-PLAN RPC Objective 20x/0.40
- M-864 IOS LWD U-PLAN RPC Objective 40x/0.65

Fluo Attachments

- M-676 Empty fluorescence filterblock
- M-677 Fluorescence filter set V (filterblock included)
- M-677.1 Fluorescence filter set V (filterblock NOT included)
- M-677ND Neutral density ND filter, 25% transmission
- M-678 Fluorescence filter set UV-DAPI (filterblock included)
- M-678.1 Fluorescence filter set UV-DAPI (filterblock NOT included)
- M-678ND Neutral density ND filter, 50% transmission
- M-797 HBO fluo attachment, 2-pos. (B&G filter set)
- M-798 HBO fluo attachment, 4-pos. (B&G filter set)
- M-1230 Blue LED Fluorescence Cube (LED+Filterset), for IM-300LD4
- M-1230.1 Blue (pass band)LED Fluorescence Cube (LED+Filterset), for IM-300LD4
- M-1231 Green LED Fluorescence Cube (LED+Filterset), for IM-300LD4
- M-1231.1 Green (pass band) LED Fluorescence Cube (LED+Filterset), for IM-300LD4
- M-1232 Violet LED Fluorescence Cube (LED+Filterset), for IM-300LD4
- M-1233 UV LED Fluorescence Cube (LED+Filterset), for IM-300LD4
- M-1233.1 UV (pass band) LED Fluorescence Cube (LED+Filterset), for IM-300LD4
- M-1234 Red 1 LED Fluorescence Cube (LED+Filterset), for IM-300LD4
- M-1235 Red 2 LED Fluorescence Cube (LED+Filterset), for IM-300LD4
- M-1236 Deep Red LED Fluorescence Cube (LED+Filterset), for IM-300LD4
- M-1237 Far Red LED Fluorescence Cube (LED+Filterset), for IM-300LD4
- M-1238 Amber LED Fluorescence Cube (LED+Filterset), for IM-300LD4

Stages

- M-792 Mechanical stage for IM-300 (except IM-300LD2 and IM-300LD4)
- M-792.2 Mechanical stage for IM-300 (IM-300LD2 only)
- M-793.1 Holder for Petri 38mm diameter (M-793.2 needed)

- M-793.2 Holder for Terasaki and Petri 65mm diameter
- M-793.3 Holder for slides and Petri 54mm diameter
- M-793.4 Holder for 2+2 slides
- M-793.5 Holder for metallurgical samples
- M-793.6 Holder for Utermohl-Chamber (M-793.3 needed)
- M-793.7 Load bearing side extension

Condensers & Filters

- M-1004.N Centering telescope (30mm Ø)
- M-785.2N Slider with phase rings (4x/10x, 20x/40x, BF)
- M-860 Slider with rotating 10x-20x-40x OPTIKA Modulation Contrast (OMC) (IM-300/IM-5)
- M-860.1 Slider with rotating 4x OPTIKA Modulation Contrast (OMC) (IM-300/IM-5)

Camera Adapters

- M-113.1 Ring adapter, 30mm (for monocular and binocular microscopes)
- M-114 0.5x C-Mount projection lens
- M-115 0.35x C-Mount projection lens
- M-118 0.75x C-Mount projection lens
- M-173 T2-Mount projection lens for APS-C/full frame reflex cameras (trino) (T2 ring not included)
- M-620 0.35x focusable C-Mount adapter
- M-620.1 0.5x focusable C-Mount adapter
- M-620.2 0.65x focusable C-Mount adapter
- M-620.3 1x focusable C-Mount adapter
- M-699 Universal adapter for projection lens (trino)

Accessories

- AB-030 Antibacterial surface treatment, for B-800/1000, IM-300/5/7, IS
- AB-040 Antibacterial surface treatment, for B-800/1000, IM-300/5/7, IS
- DC-004 TNT dust cover, large, 700(l)x550(h) mm
- M-005 Micrometric slide, 26x76mm, 2 scales (1mm/100 & 10mm/100)
- M-151.1 HBO 100W high-pressure mercury bulb for fluorescence
- M-787 Cut-off filter (infrared)
- M-977 Green filter, 45mm diameter
- VP-IM300 IQ/OQ/PQ manual for IM-300

* If the use of a camera is needed, when used for red emission fluorescence wavelengths above 650nm, please order it by specifying with "AR GLASS"

15104 - Cleaning kit

It cleans glass quickly and effectively, without leaving residue or odor. Ideal for precision lens or prism cleaning.



How to connect the cameras to our microscopes.

Please refer to the Adapter reference list on Digital section.

v 7.5 - OPTIKA reserves the right to make corrections, modifications, enhancements, improvements and other changes to its products at any time without notice.

Headquarters and Manufacturing Facilities

OPTIKA® S.r.l. Via Rigla, 30 - 24010 Ponteranica (BG) - ITALY - Tel.: +39 035.571.392 - info@optikamicroscopes.com

Optika Sales branches

OPTIKA® Spain spain@optikamicroscopes.com
OPTIKA® China china@optikamicroscopes.com
OPTIKA® India india@optikamicroscopes.com

OPTIKA® North America namerica@optikamicroscopes.com
OPTIKA® Central America camerica@optikamicroscopes.com
OPTIKA® Africa africa@optikamicroscopes.com

OPTIKA[®]
M I C R O S C O P E S
I T A L Y

IM-5 Series



Routine & Research Lab Inverted Microscopes

The Best Option for Routine & Research

INTUITIVE YET SUPERIOR CONFIGURATIONS FOR PROFESSIONALS

- » Wide range to fulfill specific lab requirements
- » Valuable solutions for life and material sciences
- » Compliant with several observation methods

AN AFFORDABLE PARTNER WITH UNIQUE HIGH-END FEATURES

- » IOS LWD U-PLAN objectives for flat images on 24 mm FN
- » Fast, efficient investigation with no particular sample prep
- » Trinocular port with beam splitter for most light-demanding needs



Optically Impressive

MAINTAINING GOOD EYESIGHT

- » 10x/24 eyepieces for the highest F.O.V. on an inverted microscope
- » Comfortable rubber cup to get rid of annoying external light
- » High eye-point for glasses wearers and dioptic adjustment

IM-5 & IOS U-PLAN: THE PERFECT COMBINATION

- » IOS Infinity corrected optical system
- » Full planarity optics on 24 mm (U-PLAN) according to ISO 19012-1
- » High-grade Semi-Apo lens available ideal for fluorescence



An Extensive Range of Different Configurations

OBSERVE EVEN THE MOST COMPLEX SAMPLES

- » Phase contrast lens for transparent sample examination
- » Motorized LED fluorescence available for specific purposes
- » High quality no cover glass objectives for material science

AUTOMATIC LED SELECTION & CONCEPTUAL INNOVATION IN LED FLUORESCENCE

- » Choose the fluorescence filter for motorized LED selection
- » Immediate operation, eliminating warm-up/cool-down times
- » Forget about lamp centering, adjustment and maintenance

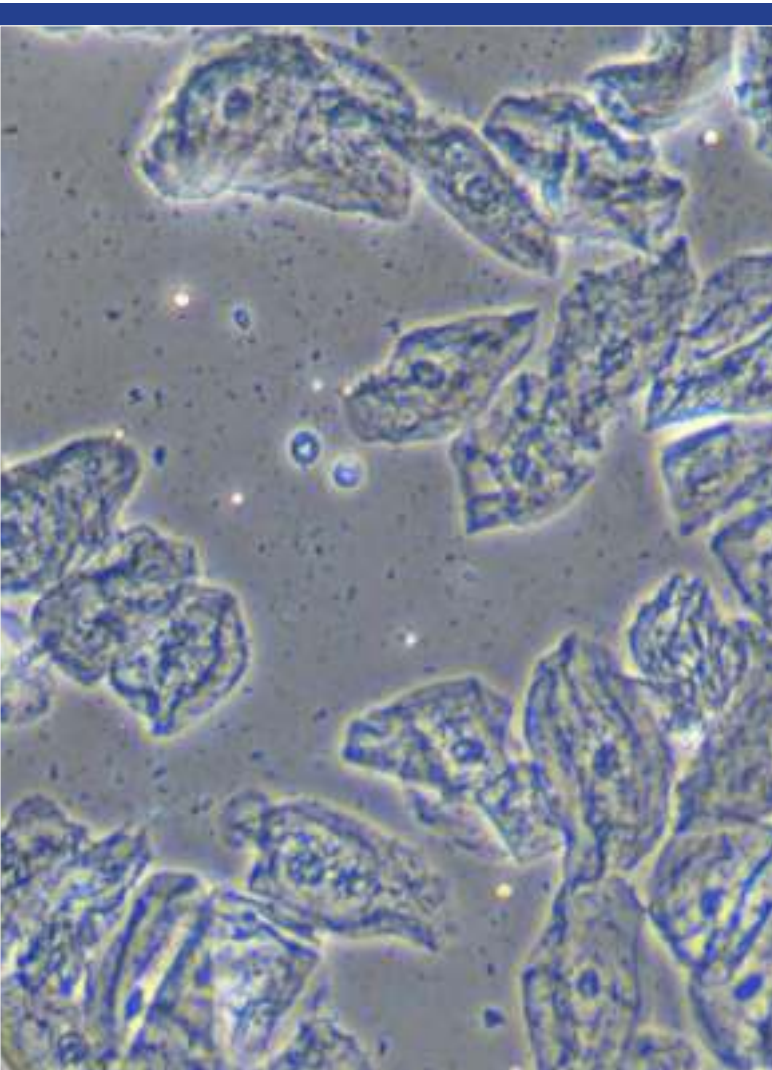

RPC Modulation Contrast

RPC system is designed to increase visibility and contrast in unstained and living material by detecting optical gradients (or slopes) and converting them into variations of light intensity. Typical applications are transparent specimens, bacteria, tissue culture work, spermatozoa, cells in glass containers, protozoa, mites, fibers, etc.

When viewed under modulation contrast optics, transparent objects that are essentially invisible in ordinary brightfield microscopy take on an apparent three-dimensional appearance dictated by phase gradients in the specimen. There are also no halos exhibited in the image, unlike the images produced with phase contrast optics.

RPC is recommended over **DIC** technique in case of specimens like crystals (with effects upon polarized light), or contained in specimen carriers such as plastic culture vessels, Petri dishes, etc.

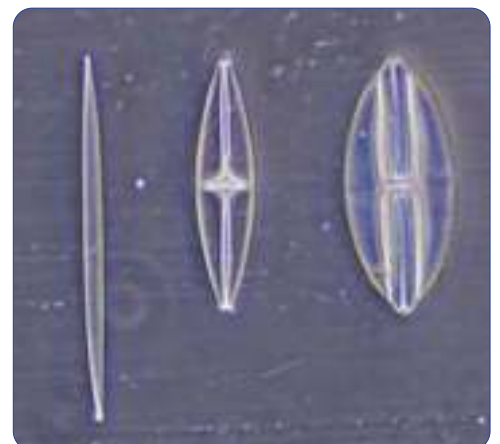

Born To Be Professional

DESIGNED TO FACILITATE YOUR DAILY ACTIVITIES

- » Mechanical stage and side extensions for great comfort
- » Large, resistant stage to easily and quickly process samples
- » Different inserts available according to the container used

CREATE YOUR COMPLETE, FLEXIBLE WORKING STATION

- » Integrable micromanipulation system available
- » Hoffman® modulation contrast available
- » Stage top incubation system available



Go Digital - Vivid Colors & Contrast For Stunning Images

2

STAY CONNECTED WITH YOUR SPECIMEN, EASILY

- » Trinocular port to be always updated with the latest technology cameras, even in the future
- » Wide range of cameras matching all the needs, including the more specific ones
- » Modern C-mount focusable professional adapters for all kinds of cameras

PROFESSIONAL IMAGE ANALYSIS

- » Multi-language software for live-view, picture and video in different file formats
- » Advanced functions for pictures processing (EDF, stitching, multi-fluorescence combine)
- » Powerful tools to perform measurements and generate custom reports

Laboratory



X-LED⁸ - Only Available at OPTIKA

STATE-OF-THE-ART ILLUMINATION SYSTEM

- » Uncomparable light intensity, exclusive lens & collector design
- » Constant pure-white color temperature at all intensity levels
- » Unmatched color fidelity, uniformity and brightness

CUT ELECTRICITY BILLS BY 90%

- » Money & energy saving, 8 W (on X-LED⁸)
- » More efficient brightness than a 100 W (for X-LED⁸) halogen lamp
- » LED long lifetime (65,000 hours = 22 years at 8 hours/day usage)

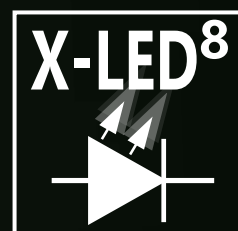

Adjust It To Your Individual Needs

FULLY SETTABLE, ADJUSTABLE IN HEIGHT CONDENSER FOR PERFECT IMAGING

- » Full Koehler illumination for enhanced images
- » Field & aperture diaphragms, centrable; N.A. 0.50 condenser
- » Removable/rotatable condenser to increase the working distance

IMPROVED OPTICAL PERFORMANCE, LONG WORKING DISTANCE

- » Superior image quality, crisp and bright details
- » Excellent contrast and resolution due to high numerical apertures
- » Comprehensive range of objectives for extended versatility



IM-5 Series

BRIGHTFIELD

Transmitted brightfield illumination is one of the most commonly used observation method in optical microscopy, and is ideal for fixed, stained specimens or other types of samples having high natural absorption of visible light.

IM-3 Series is fitted with high-efficiency LED brightfield illuminator, for the best outcome when using this technique.

Capsella middle embryo - IM-3 - Brightfield

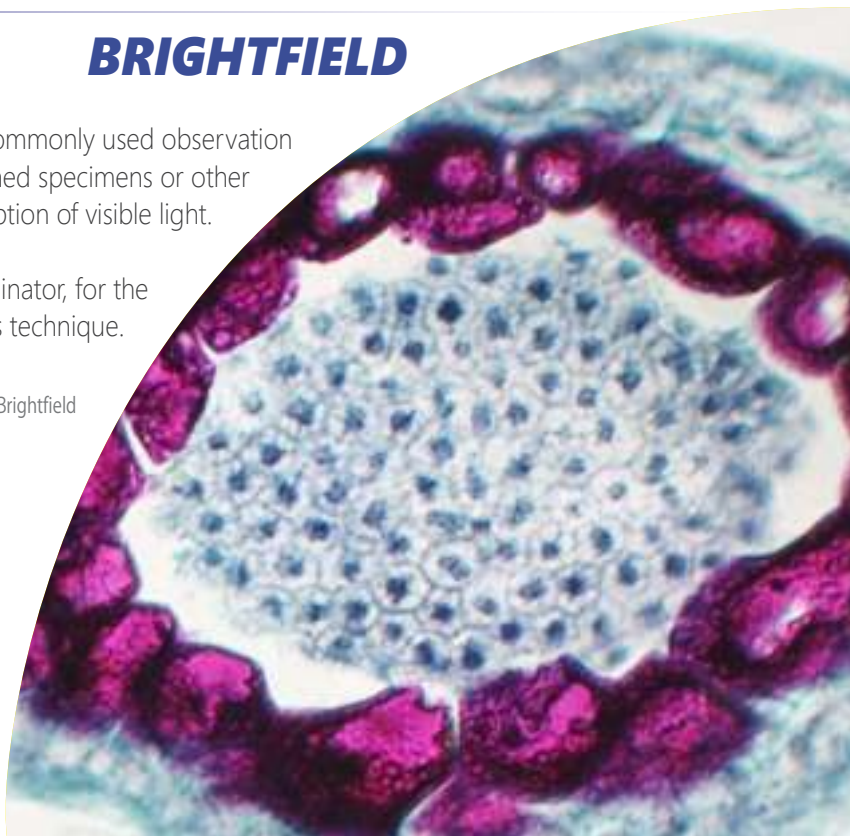

FLUORESCENCE

The fluorescence microscopy is the most demanding technique in biology and biomedical sciences, as well as in materials science.

This method is capable to study organic and inorganic samples thanks to primary fluorescence (auto-fluorescence) or secondary (staining and labelling with fluorochromes)

IM-Series is tailored for applications in research, clinical and pharmaceutical diagnostic field.

Fluorescence illuminators available as mercury lamp (IM-3F & IM-3FL4) and also as LED (IM-3LD).

Cotton fibers - IM-3FL4 - UV Fluorescence



Multiple Observation Methods

MATERIAL SCIENCE / METALLOGRAPHY

Reflected light microscopy is the method for observation of specimens that remain opaque even when ground to a thickness of few microns. The range of specimens falling into this category is incredibly wide and includes most metals, ores, ceramics, many polymers, semiconductors (unprocessed silicon, wafers, and integrated circuits), coal, plastics, paint, paper, wood, leather, glass inclusions, and a wide variety of specific materials.

Brass (not polished) - IM-3MET - Material Science

PHASE CONTRAST

Phase-contrast microscopy is a particular technique applied in transparent, non-stainable, samples like culture of living cells, microorganisms, lithographic patterns, latex dispersions, fibers, asbestos and subcellular particles.

It reveals many cellular structures that are not visible with a simple brightfield microscope.

Diatoms - IM-3 - Phase contrast

IM-5 Series



Significant Time And Money Saving

The IM-5 Series has been designed to increase comfort and achieve significant benefits, especially in terms of time saving with quick and intuitive installation, pre-aligned phase contrast system and pre-aligned LED light source.

As time is money, these features bring to a drastic impact on cost reduction, even more evident thanks to the exclusive illumination system provided by OPTIKA.

X-LED[®] Exclusive Lighting Source

Special technology able to double the light intensity for incomparable performance, ensuring constant pure-white colour temperature (6,300K colour temperature).

Relevant money and energy saving thanks to the incredibly low energy consumptions which allows you to cut the electricity bills by 90%!

The electric consumption (8 W) proves the high efficiency of this system: incredibly high light intensity combined with low consumption.

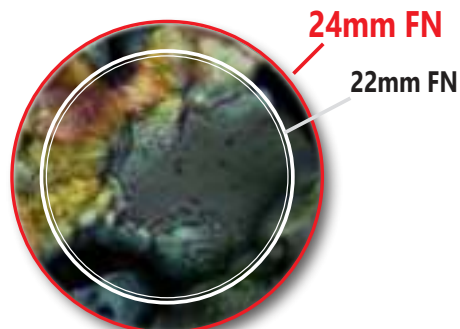

The Widest Specimen Area Available (24mm Field Number)

The **F.O.V.** (field of view) is based on a very comfortable diameter of 24 mm.

This means that an extra wide area of the sample can be inspected and allows a natural and easy view, particularly needed in a laboratory environment.

Panel With LED Illumination Indicator And ECO Function

IM-5 ensures significant repeatability since the level of light intensity can be seen at any time from the frontal panel in order to reproduce the same conditions. "ECO" button makes the microscope more environmentally sensitive, with automatic switch-off after 20 minutes of inactivity.



Routine & Research Lab Inverted Microscopes

In fluorescence we offer the latest technology.

IM-5FLD is a state-of-the art LED fluorescence microscope, equipped with motorized selection of the best LED according to the filter selected (blue, green, UV and an empty position fo optional filter) by using the filter holder slide.

Innovative, LED Fluorescence

- » Cost-effective, money saving technology
- » Ready for immediate operation
- » Eliminate warm-up/cool-down times
- » Forget lamp replacement & centering



Get the most out of our accessories



M-793.4
Holder for 2+2 slides.
(Only for IM-5 and IM-5FLD)



M-793.5
Holder for small metallurgical samples.
(Only for IM-5MET)



M-793.6
Holder for Utermöhl-Chamber.
(Only for IM-5 and IM-5FLD)

Accessories included



Holder for Petri diameter 38mm.
(Included with IM-5 and IM-5FLD)



Holder for Terasaki and Petri
diameter 65mm.
(Included with IM-5 and IM-5FLD)



Holder for slide and Petri
diameter 54mm.
(Included with IM-5 and IM-5FLD)

IM-5 - Brightfield & Phase Contrast Microscope

Phase contrast, brightfield and darkfield (dry) trinocular inverted microscope ideal for laboratory requirements (especially cell culture), with freely configurable lenses according to customer's preferences, FN 24 high eyepoint, infinity corrected optical system, coaxial focusing, mechanical stage, Abbe condenser and powerful, uniform, white color temperature 8 W **X-LED[®]**. Sturdy and incredibly reliable, it is equipped with all the main controls in ergonomic position and with long lasting LED illumination to provide over 20 years of use.



IM-5 - Specifications



Part	Description
Head:	Trinocular (fixed 50/50), 45° inclined.
Interpupillary distance:	Adjustable between 50 and 75 mm.
Dioptric adjustment:	Both eyepieces.
Eyepieces:	WF10x/24 mm, high eyepoint and with retractable rubber cups.
Nosepiece:	Quintuple ball bearings revolving nosepiece, reversed.
Objectives:	Selectable according to customer's preferences. All with anti-fungus treatment.
Specimen stage:	Fixed stage, 215x250 mm and attachable mechanical stage, 290x250 mm, 120x80 mm X-Y movement range.
Focusing:	Coaxial coarse and fine focusing mechanism with limit stop to prevent the contact between objective and specimen. Adjustable tension of coarse focusing knob.
Condenser:	Abbe N.A. 0.50, removable, with iris diaphragm and slider for phase contrast.
Transmitted illumination (Full Koehler):	X-LED [®] with white 8 W LED and brightness control. Color temperature: 6,300 K. Multi-plug 100-240Vac/12Vdc external power supply.

IM-5 is freely configurable in terms of objectives, by choosing among:

Included ■ Optional □

Infinity-corrected Plan-Achromatic, Long Working Distance objectives, field flatness up to F.N. 22:

M-782	IOS LWD W-PLAN objective 4x/0.13	□
M-773	IOS LWD W-PLAN objective 40x/0.60	□
M-786	IOS LWD W-PLAN objective 60x/0.70	□

Positive Phase Contrast Infinity-corrected Plan-Achromatic, Long Working Distance objectives, field flatness up to F.N. 22:

M-782.1	IOS LWD W-PLAN PH objective 4x/0.13	□
M-783N	IOS LWD W-PLAN PH objective 10x/0.25	□
M-784N	IOS LWD W-PLAN PH objective 20x/0.40	□
M-785	IOS LWD W-PLAN PH objective 40x/0.65	□

Infinity-corrected Semi-Apochromatic, Long Working Distance objectives, field flatness up to F.N. 25:

M-800	IOS LWD U-PLAN F objective 4x/0.13	□
M-801	IOS LWD U-PLAN F objective 10x/0.30	□
M-802	IOS LWD U-PLAN F objective 20x/0.45	□
M-803	IOS LWD U-PLAN F objective 40x/0.65	□
M-804	IOS LWD U-PLAN F objective 60x/0.75	□

Positive Phase Contrast Infinity-corrected Semi-Apochromatic, Long Working Distance objectives, field flatness up to F.N. 25:

M-1177	IOS LWD U-PLAN F PH objective 20x/0.45	□
M-1178	IOS LWD U-PLAN F PH objective 40x/0.65	□

IM-5FLD - LED Fluorescence Microscope

Phase contrast, brightfield and darkfield (dry) LED fluorescence trinocular inverted microscope, with freely configurable lenses according to customer's preferences, FN 24 high eyepoint, infinity corrected optical system, coaxial focusing, mechanical stage, Abbe condenser and powerful, uniform, white color temperature 8 W **X-LED8**. The 4-position epi-fluorescence attachment is powered by extremely powerful 5 W LEDs fluorescence illuminator and combined with blue, green and UV excitation filters for the visualization of the following fluorochromes: Acridine Yellow, Acridine Orange, Auramine, DiO, DTAF, FITC, GFP, YFP (blue filter) plus Rhodamine, Texas Red and TRITC (green filter) plus Alexa Fluor® 350, 7- Amino-4-methylcoumarin, 6-Aminoquinoline, Calcofluor® White, Dansyl cadaverine, DAPI, Dapoxyl, DIDS, Europium (III) Chloride, Fluoro-Gold™, Fura-2, Hoechst 33342 & 33258, 1,5 IAEDANS, Indo-1, Marina Blue®, 4-Methylumbelliferone, PBF1, Pyrene, SBF1, Y66F, Y66H (UV filter) among the others. LED fluorescence ensures unparalleled convenience eliminating warm-up/cool-down times and all the inconveniences related lamp replacement and adjustment. Sturdy and incredibly reliable, it is equipped with all the main controls in ergonomic position and with long lasting, efficient LED illumination to provide over 20 years of use.



IM-5FLD - Specifications



Part	Description
Head:	Trinocular (split ratio: 100/0, 0/100), 45° inclined.
Interpupillary distance:	Adjustable between 50 and 75 mm.
Dioptric adjustment:	Both eyepieces.
Eyepieces:	WF10x/24 mm, high eyepoint and with retractable rubber cups.
Epi-fluorescence illumination & filters:	High-power 5 W LEDs with brightness control, motorized LED selection with centrable field diaphragm, 4-position filter holder; blue (EX 450-490, DM 495, EM 500-550), green (EX 540-580, DM 585, EM 608-682) and UV (EX 340-390, DM 400, EM 420LP) excitation filters included.
Nosepiece:	Quintuple ball bearings revolving nosepiece, reversed.
Objectives:	Selectable according to customer's preferences. All with anti-fungus treatment.
Specimen stage:	Fixed stage, 215x250 mm and attachable mechanical stage, 290x250 mm, 120x80 mm X-Y movement range.
Focusing:	Coaxial coarse and fine focusing mechanism with limit stop to prevent the contact between objective and specimen. Adjustable tension of coarse focusing knob.
Condenser:	Abbe N.A. 0.50, removable, with iris diaphragm and slider for phase contrast.
Transmitted illumination (Full Koehler):	X-LED® with white 8 W LED and brightness control. Color temperature: 6,300 K. Multi-plug 100-240Vac/12Vdc external power supply.

Fluorescence filtersets

Name	Excitation filter (nm)	Dichroic mirror cut-off (nm)	Emission filter (nm)
B (Blue)	450 – 490	495	500 - 550
G (Green)	540 – 580	585	607 - 682
UV (Ultraviolet)	340 -390	400	420LP

IM-5FLD is freely configurable in terms of objectives, by choosing among:

Included ■ Optional □

Infinity-corrected Plan-Achromatic, Long Working Distance objectives, field flatness up to F.N. 22:		
M-782	IOS LWD W-PLAN objective 4x/0.13	□
M-773	IOS LWD W-PLAN objective 40x/0.60	□
M-786	IOS LWD W-PLAN objective 60x/0.70	□

Infinity-corrected Semi-Apochromatic, Long Working Distance objectives, field flatness up to F.N. 25:		
M-800	IOS LWD U-PLAN F objective 4x/0.13	□
M-801	IOS LWD U-PLAN F objective 10x/0.30	□
M-802	IOS LWD U-PLAN F objective 20x/0.45	□
M-803	IOS LWD U-PLAN F objective 40x/0.65	□
M-804	IOS LWD U-PLAN F objective 60x/0.75	□

Positive Phase Contrast Infinity-corrected Plan-Achromatic, Long Working Distance objectives, field flatness up to F.N. 22:		
M-782.1	IOS LWD W-PLAN PH objective 4x/0.13	□
M-783N	IOS LWD W-PLAN PH objective 10x/0.25	□
M-784N	IOS LWD W-PLAN PH objective 20x/0.40	□
M-785	IOS LWD W-PLAN PH objective 40x/0.65	□

Positive Phase Contrast Infinity-corrected Semi-Apochromatic, Long Working Distance objectives, field flatness up to F.N. 25:		
M-1177	IOS LWD U-PLAN F PH objective 20x/0.45	□
M-1178	IOS LWD U-PLAN F PH objective 40x/0.65	□

IM-5MET - Metallurgical Microscope

Industrial and materials science inverted microscope especially designed for opaque specimens (including metals microstructure investigation and studies such as grain size, grain boundaries, phases, transformation, inclusions, and non-metals, as well as sample preparation and treatment) in metallography labs. Freely configurable lenses according to customer's preferences, FN 24 high eyepoint, infinity corrected optical system, coaxial focusing, mechanical stage, and epi-illumination attachment powered by halogen 12 V/100 W with brightness control. Sturdy and incredibly reliable, it is equipped with all the main controls in ergonomic position and with long lasting, efficient LED illumination to provide over 20 years of use.

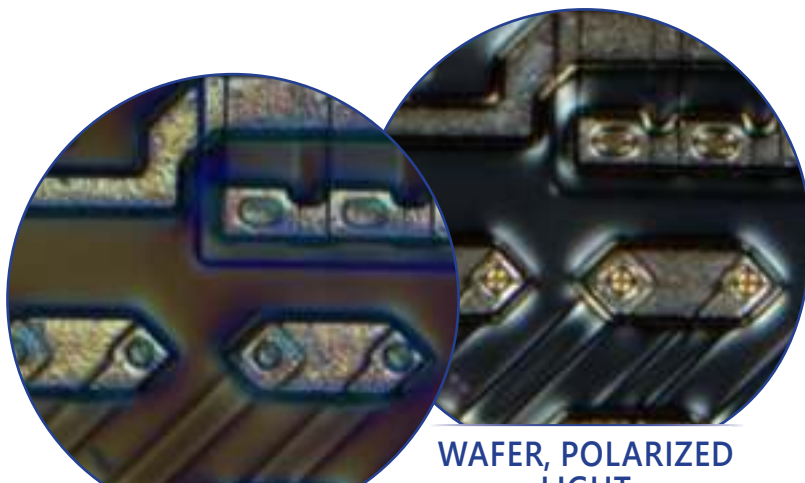

WAFER, DIC

WAFER, POLARIZED
LIGHT



IM-5MET - Specifications



Part	Description
Head:	Trinocular (split ratio: 100/0, 50/50), 45° inclined.
Interpupillary distance:	Adjustable between 50 and 75 mm.
Dioptric adjustment:	Both eyepieces.
Eyepieces:	WF10x/24 mm, high eyepoint, secured by screw and with retractable rubber cups.
Epi-illumination & filters:	Halogen 12 V/100 W with brightness control. With field and aperture diaphragms, polarizer and analyzer filters.
Nosepiece:	Quintuple ball bearings revolving nosepiece, reversed.
Objectives:	Selectable according to customer's preferences. All with anti-fungus treatment.
Specimen stage:	Mechanical stage, 240x250 mm.
Focusing:	Coaxial coarse and fine focusing mechanism with limit stop to prevent the contact between objective and specimen. Adjustable tension of coarse focusing knob.

IM-5MET is freely configurable in terms of objectives, by choosing among:

Included Optional

MET Infinity-corrected Plan-Achromatic, Long Working Distance objectives, field flatness up to F.N. 25:		
M-1100	IOS LWD U-PLAN MET objective 5x/0.15	<input type="checkbox"/>
M-1101	IOS LWD U-PLAN MET objective 10x/0.30	<input type="checkbox"/>
M-1102	IOS LWD U-PLAN MET objective 20x/0.45	<input type="checkbox"/>
M-1103	IOS LWD U-PLAN MET objective 50x/0.55	<input type="checkbox"/>
M-1104	IOS LWD U-PLAN MET objective 100x/0.80 (dry)	<input type="checkbox"/>

MET Infinity-corrected Semi-Apochromatic, Long Working Distance objectives, field flatness up to F.N. 25:		
M-1171	IOS LWD U-PLAN F MET objective 5x/0.15	<input type="checkbox"/>
M-1172	IOS LWD U-PLAN F MET objective 10x/0.30	<input type="checkbox"/>
M-1173	IOS LWD U-PLAN F MET objective 20x/0.50	<input type="checkbox"/>
M-1174	IOS LWD U-PLAN F MET objective 50x/0.80	<input type="checkbox"/>
M-1175	IOS LWD U-PLAN F MET objective 100x/0.90 (dry)	<input type="checkbox"/>

MET Infinity-corrected Plan-Achromatic, Long Working Distance objectives, for brightfield and darkfield, field flatness up to F.N. 25:		
M-1094	IOS LWD U-PLAN MET BD objective 5x/0.15	<input type="checkbox"/>
M-1095	IOS LWD U-PLAN MET BD objective 10x/0.30	<input type="checkbox"/>
M-1096	IOS LWD U-PLAN MET BD objective 20x/0.45	<input type="checkbox"/>
M-1097	IOS LWD U-PLAN MET BD objective 50x/0.55	<input type="checkbox"/>
M-1098	IOS LWD U-PLAN MET BD objective 100x/0.80 (dry)	<input type="checkbox"/>

MET Infinity-corrected Semi-Apochromatic, Long Working Distance objectives, for brightfield and darkfield, field flatness up to F.N. 25:		
M-1180	IOS LWD U-PLAN F MET BD objective 5x/0.15	<input type="checkbox"/>
M-1181	IOS LWD U-PLAN F MET BD objective 10x/0.30	<input type="checkbox"/>
M-1182	IOS LWD U-PLAN F MET BD objective 20x/0.50	<input type="checkbox"/>
M-1183	IOS LWD U-PLAN F MET BD objective 50x/0.80	<input type="checkbox"/>
M-1184	IOS LWD U-PLAN F MET BD objective 100x/0.90 (dry)	<input type="checkbox"/>

IM-5 Series - Comparison Chart

Common features:

- **Head:** Trinocular (2-position 100/0, 0/100), 45° inclined.
- **Eyepieces:** PL10x/24 mm, with dioptic adjustment, high eye-point and rubber cups. Dioptic adjustment on both eyepieces.
- **Focusing mechanism:** Coaxial coarse (adjustable tension) and fine focusing mechanism with limit stop to prevent the contact between objective and specimen.

Model	Type	Nosepiece	Stage	Condenser	Incident illumination	Fluorescence slider	Transmitted illumination
IM-5	BF, PH	Quintuple revolving nosepiece, rotation on ball bearings	Fixed, 215x250 mm can be equipped with mechanical (included), 290x250 mm, 120x80 mm movement range	N.A. 0.50 Köhler, W.D. 28 mm, rotatable to extend the W.D.	-	-	8 W X-LED [®] , brightness control and ECO function
IM-5FLD	BF, FL, PH	Quintuple revolving nosepiece, rotation on ball bearings	Fixed, 215x250 mm can be equipped with mechanical (included), 290x250 mm, 120x80 mm movement range	N.A. 0.50 Köhler, W.D. 28 mm, rotatable to extend the W.D.	FL LED with Blue, Green and UV filtersets	4-position	8 W X-LED [®] , brightness control and ECO function
IM-5MET	BF MET, DF MET	Quintuple revolving nosepiece, rotation on ball bearings. With 26 mm thread holes, 5 adapter rings (for RMS objectives) and DIC slot	Rackless, mechanical, 240x250 mm, 50x50 mm movement range	-	Halogen bulb, 12 V/100 W, brightness control and ECO function	-	-



IM-5 Series - Optical Performance

Infinity-corrected Plan-Achromatic, Long Working Distance objectives, field flatness up to F.N. 22:

Eyepiece		10x (M-880)		
Field number		24 (mm)		
Objective	N.A.	W.D. (mm)	Total magnification	Field of view (mm)
4x	0.13	10.40	40x	6.0
40x	0.60	3.10	400x	0.60
60x	0.70	1.70	600x	0.40

Infinity-corrected Semi-Apochromatic, Long Working Distance objectives, field flatness up to F.N. 25:

Eyepiece		10x (M-880)		
Field number		24 (mm)		
Objective	N.A.	W.D. (mm)	Total magnification	Field of view (mm)
4x	0.13	18.52	40x	6.0
10x	0.30	7.11	100x	2.4
20x	0.45	5.91	200x	1.2
40x	0.65	1.61	400x	0.60
60x	0.75	1.04	600x	0.40

Positive Phase Contrast Infinity-corrected Plan-Achromatic, Long Working Distance objectives, field flatness up to F.N. 22:

Eyepiece		10x (M-880)		
Field number		24 (mm)		
Objective	N.A.	W.D. (mm)	Total magnification	Field of view (mm)
4x	0.13	10.40	40x	6.0
10x	0.25	7.30	100x	2.4
20x	0.40	6.80	200x	1.2
40x	0.60	3.00	400x	0.60

Positive Phase Contrast Infinity-corrected Semi-Apochromatic, Long Working Distance objectives, field flatness up to F.N. 25:

Eyepiece		10x (M-880)		
Field number		24 (mm)		
Objective	N.A.	W.D. (mm)	Total magnification	Field of view (mm)
20x	0.45	5.91	20x	1.2
40x	0.65	1.61	400x	0.60

MET Infinity-corrected Plan-Achromatic, Long Working Distance objectives, field flatness up to F.N. 25:

Eyepiece		10x (M-880)		
Field number		24 (mm)		
Objective	N.A.	W.D. (mm)	Total magnification	Field of view (mm)
5x	0.15	10.80	50x	4.8
10x	0.30	10.00	100x	2.40
20x	0.45	4.00	200x	1.20
50x	0.55	7.90	500x	0.48
100x	0.80	2.10	1000x	0.24

MET Infinity-corrected Semi-Apochromatic, Long Working Distance objectives, field flatness up to F.N. 25:

Eyepiece		10x (M-880)		
Field number		24 (mm)		
Objective	N.A.	W.D. (mm)	Total magnification	Field of view (mm)
5x	0.15	19.50	50x	4.8
10x	0.30	10.9	100x	2.40
20x	0.50	3.20	200x	1.20
50x	0.80	1.2	500x	0.48
1000x	0.90	1.00	1000x	0.24

MET Infinity-corrected Plan-Achromatic, Long Working Distance objectives, for brightfield and darkfield, field flatness up to F.N. 25:

Eyepiece		10x (M-880)		
Field number		24 (mm)		
Objective	N.A.	W.D. (mm)	Total magnification	Field of view (mm)
5x	0.15	9.00	50x	4.8
10x	0.30	9.00	100x	2.40
20x	0.45	3.40	200x	1.20
50x	0.55	7.50	500x	0.48
100x	0.80	2.00	1000x	0.24

MET Infinity-corrected Semi-Apochromatic, Long Working Distance objectives, for brightfield and darkfield, field flatness up to F.N. 25:

Eyepiece		10x (M-880)		
Field number		24 (mm)		
Objective	N.A.	W.D. (mm)	Total magnification	Field of view (mm)
5x	0.15	13.50	50x	4.8
10x	0.30	9.00	100x	2.40
20x	0.50	2.50	200x	1.20
50x	0.80	1.00	500x	0.48
100x	0.90	1.00	1000x	0.24



IM-5 Series - Accessories

Eyecups & Eyepieces

M-880	PL10x/24 eyepiece, high eyepoint, focusable, with rubber cup
M-881	PL10x/24 micrometric eyepiece, high eyepoint, focusable, rubber cup
M-882	WF15x/16 eyepiece, high eyepoint, focusable, with rubber cup

Objectives

IOS W-PLAN

M-782	IOS LWD W-PLAN objective 4x/0.10
M-773	IOS LWD W-PLAN objective 40x/0.60
M-786	IOS LWD W-PLAN objective 60x/0.70

IOS W-PLAN PH

M-782.1	IOS LWD W-PLAN PH objective 4x/0.13
M-783N	IOS LWD W-PLAN PH objective 10x/0.25
M-784N	IOS LWD W-PLAN PH objective 20x/0.40
M-785	IOS LWD W-PLAN PH objective 40x/0.65

IOS U-PLAN F

M-800	IOS LWD U-PLAN F objective 4x/0.13
M-801	IOS LWD U-PLAN F objective 10x/0.30
M-802	IOS LWD U-PLAN F objective 20x/0.45
M-803	IOS LWD U-PLAN F objective 40x/0.65
M-804	IOS LWD U-PLAN F objective 60x/0.75

IOS U-PLAN F PH

M-1177	IOS LWD U-PLAN F PH objective 20x/0.45
M-1178	IOS LWD U-PLAN F PH objective 40x/0.65

IOS U-PLAN MET (Brightfield)

M-1100	IOS LWD U-PLAN MET objective 5x/0.15
M-1101	IOS LWD U-PLAN MET objective 10x/0.30
M-1102	IOS LWD U-PLAN MET objective 20x/0.45
M-1103	IOS LWD U-PLAN MET objective 50x/0.55
M-1104	IOS LWD U-PLAN MET objective 100x/0.80 (dry)

IOS U-PLAN MET (Brightfield & Darkfield)

M-1094	IOS LWD U-PLAN MET BD objective 5x/0.15
M-1095	IOS LWD U-PLAN MET BD objective 10x/0.30
M-1096	IOS LWD U-PLAN MET BD objective 20x/0.45
M-1097	IOS LWD U-PLAN MET BD objective 50x/0.55
M-1098	IOS LWD U-PLAN MET BD objective 100x/0.80 (dry)

IOS U-PLAN F MET (Brightfield)

M-1171	IOS LWD U-PLAN F MET objective 5x/0.15
M-1172	IOS LWD U-PLAN F MET objective 10x/0.30
M-1173	IOS LWD U-PLAN F MET objective 20x/0.50
M-1174	IOS LWD U-PLAN F MET objective 50x/0.80
M-1175	IOS LWD U-PLAN F MET objective 100x/0.90 (dry)

IOS U-PLAN F MET (Brightfield & Darkfield)

M-1180	IOS LWD U-PLAN F MET BD objective 5x/0.15
M-1181	IOS LWD U-PLAN F MET BD objective 10x/0.30
M-1182	IOS LWD U-PLAN F MET BD objective 20x/0.50
M-1183	IOS LWD U-PLAN F MET BD objective 50x/0.80
M-1184	IOS LWD U-PLAN F MET BD objective 100x/0.90 (dry)

IOS LWD U-PLAN RPC

M-861	IOS LWD U-PLAN RPC objective 4x/0.13
M-862	IOS LWD U-PLAN RPC objective 10x/0.25
M-863	IOS LWD U-PLAN RPC objective 20x/0.40
M-864	IOS LWD U-PLAN RPC objective 40x/0.65

Condensers & Filters

M-550	Interferential green filter IF550 (except for IM-5MET)
M-677ND	Neutral density filter, 25% transmission (only for IM-5MET)
M-678ND	Neutral density filter, 50% transmission (only for IM-5MET)

Camera Adapters

M-113.1	Ring adapter, 30mm (for monocular and binocular microscopes)
M-115	0.35x C-Mount projection lens
M-114	0.5x C-Mount projection lens
M-118	0.75x C-Mount projection lens
M-173	C-Mount projection lens for APS-C/full frame reflex cameras (trino)
M-620	0.35x focusable C-Mount adapter (biological microscopes)
M-620.1	0.5x focusable C-Mount adapter (biological microscopes)
M-620.2	0.65x focusable C-Mount adapter (biological microscopes)
M-620.3	1x focusable C-Mount adapter (biological & stereomicroscopes)
M-699	Universal adapter for C-Mount projection lens (trino)

Miscellaneous

15104	Cleaning kit
CL-36	Halogen bulb 12V/100W (only for IM-5MET)
DC-005	TNT dust cover, extra large, 820(l)x550(h) mm
M-005	Micrometric slide, 26x76mm, with 2 scales (1mm/100 & 10mm/100)
M-641	Adapter for micromanipulator plate (only for IM-5)
M-793.1	Holder for Petri 38mm diameter (M-793.2 needed) (except for IM-5MET)
M-793.2	Holder for Terasaki and Petri 65mm diameter (except for IM-5MET)
M-793.3	Holder for slides and Petri 54mm diameter (except for IM-5MET)
M-793.4	Holder for 2+2 slides (except for IM-5MET)
M-793.5	Holder for metallurgical samples (only for IM-5MET)
M-793.6	Holder for Utermohl-Chamber (M-793.3 needed) (except for IM-5MET)
M-793.7	Load bearing side extension (except for IM-5MET)
M-860	Slider with rotating 10x-20x-40x OPTIKA Modulation Contrast slit
M-860.1	Slider with rotating 4x OPTIKA Modulation Contrast slit
M-870	DIC slider with Nomarski prism for reflected light (only for IM-5MET)
VP-IM5	IQ/OQ/PQ manual for IM-5 series
AB-030	Antibacterial surface treatment, only for newly purchased microscope

15104 - Cleaning kit

It cleans glass quickly and effectively, without leaving residue or odor. Ideal for precision lens or prism cleaning.



How to connect the cameras to our microscopes.
Please refer to the Adapter reference list on Digital section.

v 7.5 - OPTIKA reserves the right to make corrections, modifications, enhancements, improvements and other changes to its products at any time without notice.

Headquarters and Manufacturing Facilities

OPTIKA® S.r.l. Via Rigla, 30 - 24010 Ponteranica (BG) - ITALY - Tel.: +39 035.571.392 - info@optikamicroscopes.com

Optika Sales branches

OPTIKA® Spain spain@optikamicroscopes.com
OPTIKA® China china@optikamicroscopes.com
OPTIKA® India india@optikamicroscopes.com

OPTIKA® North America namerica@optikamicroscopes.com
OPTIKA® Central America camerica@optikamicroscopes.com
OPTIKA® Africa africa@optikamicroscopes.com

IM-7



Inverted Research Microscope

② IM-7 - Inverted Research Microscope

IM-7 represents the best of what Optika dedicates to the world of research. This model was created to meet all the needs related to research in life science and designed to be complemented by a series of packages dedicated to more advanced individual applications. For all intents and purposes, IM-7 is to be considered as an inverted imaging platform, due to its high expandability and state-of-the-art quality.



IM-7 - Inverted Research Microscope

Top-level of optical equipment among our product range provides a sharp and clear view in any situation, while top-level mechanical design offers sturdiness and long lifetime.



IM-7

BRIGHTFIELD

Transmitted brightfield illumination is one of the most commonly used observation method in optical microscopy, and is ideal for fixed, stained specimens or other types of samples having high natural absorption of visible light.

IM-7 is fitted with high-efficiency LED brightfield illuminator, for the best outcome when using this technique.

Capsella middle embryo - Brightfield

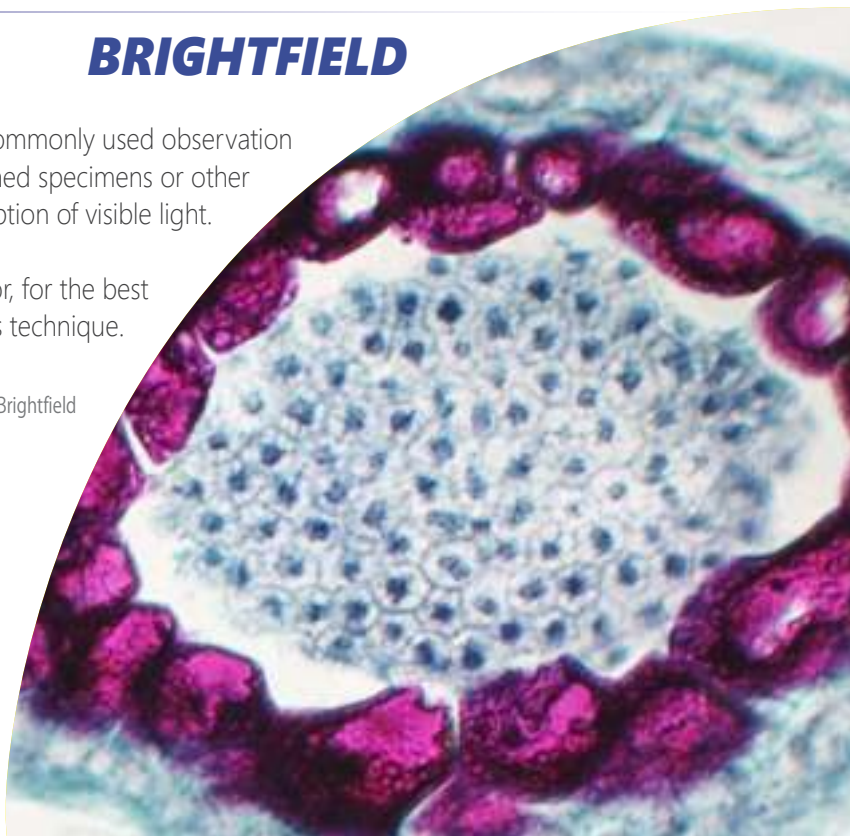

FLUORESCENCE

The fluorescence microscopy is the most demanding technique in biology and biomedical sciences, as well as in materials science.

This method is capable to study organic and inorganic samples thanks to primary fluorescence (auto-fluorescence) or secondary (staining and labelling with fluorochromes)

IM-7 is tailored for applications in research, clinical and pharmaceutical diagnostic field.

Fluorescence illuminators available as mercury lamp.

Cotton fibers - UV Fluorescence



Multiple Observation Methods

DIC

Differential Interference Contrast (DIC) is a microscopy technique that introduces contrast to images of specimens which have little or no contrast when observed using brightfield microscopy. The images produced using DIC have a pseudo 3D-effect, making the technique ideal for many applications.

DIC produces high resolution images with good contrast. It is best for observing unstained samples.

Sphagnum pores g - DIC

PHASE CONTRAST

Phase-contrast microscopy is a particular technique applied in transparent, non-stainable, samples like culture of living cells, microorganisms, lithographic patterns, latex dispersions, fibers, asbestos and subcellular particles.

It reveals many cellular structures that are not visible with a simple brightfield microscope.

Diatoms - Phase contrast

② IM-7 - Features



Revolving nosepiece for DIC and Fluorescence filter turret

The six-position nosepiece has a slot (in each of the six positions) for inserting DIC prisms.

The filter turret can hold up to six fluorescence filterblocks. It is easily extractable, in order to facilitate the operation of inserting or replacing the filterblocks.

Mechanical stage and universal condenser

The wide 3-layer mechanical stage comes with several interchangeable plates for the use of Petri dishes, flasks and slides. The movement of the stage is controlled by a long tilting handle equipped with a pair of knobs for X/Y axes.

The universal condenser is a 6-position type, designed for brightfield, phase contrast and DIC.



Illuminator arm

The arm of the transmitted illuminator is backward tilting up to 30 degrees and it allows to use flasks and big bottles.



Main photo tube and Bertrand lens

The main photo tube located on the binocular head is easily controllable by using its control knob. 3 positions selectable: 100/0, 50/50, 0/100.

For phase contrast centering operations a Bertrand lens is available and it can be easily inserted by means of a dedicated knob.

Fluorescence equipment

A complete package of accessory dedicated to Fluorescence technique is available as option.



Fluorescence filterblocks

In addition to the four standard fluorescence B-G-V-UV filterblocks, many others are available upon request to satisfy every kind of need.

② IM-7 - Features / Controls



IM-7 - Features / Controls

- 1 - Main photo tube, on binocular head
- 2 - Handle, for transportation
- 3 - Handle, for transportation
- 4 - Transmitted illuminator switch
- 5 - Fluorescence illuminator switch
- 6 - Magnification changer, 1x-1.5x
- 7 - Right side photo tube
- 8 - Universal condenser, for brightfield, PH and DIC
- 9 - Binocular head, with standard WF10x/22mm eyepieces or WF10x/25mm (optional)
- 10 - Slots for field diaphragm, aperture diaphragm, ND filters

- 11 - Input port for fluorescence illuminator
- 12 - Left side photo tube
- 13 - Side photo tubes control (100/0 ; 20/80 ; 0/100)
- 14 - Main photo tube control (100/0 ; 50/50 ; 0/100)
- 15 - Bertrand lens insertion control
- 16 - Main switch
- 17 - Slot for analyzer
- 18 - Focusing knobs
- 19 - 3-layer mechanical stage
- 20 - Transmitted illuminator brightness control



IM-7 - Standard Specifications

Part	Description
Optical system:	Infinity corrected.
Head:	Type: Trinocular (Siedentopf); Inclination 45°; Interpupillary distance 47-78 mm; Tube inner diameter 30 mm; Built-in Bertrand lens.
Photo tubes:	Trino Port/Binocular: 100/0 ; 50/50 ; 0/100; Left Side Port/Binocular: 100/0 ; 0/100.; Right Side Port/Binocular: 100/0; 20/80.
Eyepieces:	PLAN WF10x/25 mm, high eyepoint and with built-in rubber cups; focusable .
Nosepiece:	Sextuple ball bearings revolving nosepiece, reversed; DIC slots fo all positions.
Objectives:	Infinity corrected; 60 mm parfocal distance; All with anti-fungus treatment; Selectable according to customer's preferences (see objective table).
Magnification changer:	1x, 1.5x
Specimen stage:	340x230 mm, three-layers mechanical stage; 130x85 mm moving range; Moving mechanism: Rack and pinion (flexible knob); Holder for Petri dish, 160x110 mm; Holder for Terasaki plate (96 well); Holder for 1 slide. Anti-scratch painting.
Focusing:	Coaxial coarse and fine focusing mechanism with limit stop to prevent the contact between objective and specimen; Adjustable tension of coarse focusing knob; 10 mm coarse total travel; Coarse travel per single rotation: 2 mm; Fine travel per single rotation: 0.2 mm; Fine graduations: 100; Fine resolution: 2 µm.
Condenser:	Koehler type, 6-position, focusable, centrable; N.A. 0.55; Iris diaphragm; Phase contrast positions: 10x PH, 20x PH, 40x PH (rings included); DIC positions: DIC1 (10x), DIC2 (20x, 40x, 60x) (prisms not included); 26 mm working distance.
Transmitted illumination (Full Koehler):	X-LED ¹⁰ ; 10W LED, high efficiency, 6000K; Brightness control; 65.000-hour lifetime.
Incident illumination:	Upgradable to Incident Fluorescence illumination through the purchase of the components indicated in the fluorescence package table.
Differential Interference Contrast (DIC)	Upgradable to DIC through the purchase of the components indicated in the DIC package table.

IM-7 - Objectives/Application Packages

IM-7 is freely configurable in terms of objectives, by choosing among:

Included Optional

Infinity-corrected Semi-Apochromatic, Long Working Distance objectives, field flatness up to F.N. 25.
Objectives 20x, 40x, and 60x feature a correction collar in order to compensate for various thicknesses of cover glasses or different containers.

M-1320	IOS LWD U-PLAN F (SEMI-APO) PH 4x/0.13, W.D. 16.5 mm, Cover glass -	<input type="checkbox"/>
M-1321	IOS LWD U-PLAN F (SEMI-APO) PH 10x/0.3, W.D. 7.4 mm, Cover glass 1.2 mm	<input type="checkbox"/>
M-1322	IOS LWD U-PLAN F (SEMI-APO) PH 20x/0.45, W.D. 7.5 - 8.8 mm, Cover glass 0 - 2 mm	<input type="checkbox"/>
M-1323	IOS LWD U-PLAN F (SEMI-APO) PH 40x/0.60, W.D. 3.0 - 4.4 mm, Cover glass 0 - 2 mm	<input type="checkbox"/>
M-1324	IOS LWD U-PLAN F (SEMI-APO) PH 60x/0.70, W.D. 1.8 - 2.6 mm, Cover glass 0.1 - 1.3 mm	<input type="checkbox"/>

HBO Fluorescence package:

Included Optional

M-1330	EPI Fluorescence internal attachment	<input type="checkbox"/>
M-151.1	OSRAM 100W HBO high pressure mercury bulb	<input type="checkbox"/>
M-1332	HBO Lamp house	<input type="checkbox"/>
PS-HBO	Optika 100W HBO power supply	<input type="checkbox"/>
M-1334	6-position fluorescence filterbox turret	<input type="checkbox"/>
M-1335	UV protector orange shield	<input type="checkbox"/>
M-1336	B filterblock, filters included	<input type="checkbox"/>
M-1337	G filterblock, filters included	<input type="checkbox"/>
M-1338	V filterblock, filters included	<input type="checkbox"/>
M-1339	UV filterblock, filters included	<input type="checkbox"/>
M-1340	Aperture diaphragm slider	<input type="checkbox"/>
M-1341	Field diaphragm slider	<input type="checkbox"/>
M-1342	Slider with neutral density filter for HBO illumination	<input type="checkbox"/>
M-1343	Empty fluorescence filterblock	<input type="checkbox"/>

Name	Excitation filter (nm)	Dichroic cut-off mirror (nm)	Emission filter (nm)
B (Blue)	460 - 490	500	510LP
G (Green)	510 - 550	570	590LP
V (Violet)	400 - 410	455	455LP
UV (Ultraviolet)	330 - 385	400	420LP

DIC - Differential Interference Contrast package:

Included Optional

M-1350	DIC Prism for 10x	<input type="checkbox"/>
M-1351	DIC Prism for 20x	<input type="checkbox"/>
M-1352	DIC Prism for 40x	<input type="checkbox"/>
M-1353	DIC prism for 60x	<input type="checkbox"/>
M-1354	DIC 1 prism 10x for condenser	<input type="checkbox"/>
M-1355	DIC 2 prism 20x-40x-60x for condenser	<input type="checkbox"/>
M-1356	Slider with rotating analyzer	<input type="checkbox"/>

IM-7 - Accessories

Eyecups & Eyepieces

- M-1360 PL10x/25, high eyepoint, focusable, rubber cup
 M-1361 PL10x/25, micrometric eyepiece, high eyepoint, focusable, rubber cup

Objectives

- M-1320 IOS U-PLAN F (SEMI-APO) PH 4x/0.13, W.D. 16.5 mm, Cover glass -
 M-1321 IOS U-PLAN F (SEMI-APO) PH 10x/0.3, W.D. 7.4 mm, Cover glass 1.2 mm
 M-1322 IOS U-PLAN F (SEMI-APO) PH 20x/0.45, W.D. 7.5 - 8.8 mm, Cover glass 0 - 2 mm
 M-1323 IOS U-PLAN F (SEMI-APO) PH 40x/0.60, W.D. 3.0 - 4.4 mm, Cover glass 0 - 2 mm
 M-1324 IOS U-PLAN F (SEMI-APO) PH 60x/0.70, W.D. 1.8 - 2.6 mm, Cover glass 0.1 - 1.3 mm

Fluorescence package

- M-1330 EPI Fluorescence internal attachment
 M-151.1 OSRAM 100W HBO high pressure mercury bulb
 M-1332 HBO lamp house
 PS-HBO 100W HBO power supply)
 M-1334 6-position fluorescence filterbox turret
 M-1335 UV protector orange shield
 M-1336 B filterblock, filters included
 M-1337 G filterblock, filters included
 M-1338 V filterblock, filters included
 M-1339 UV filterblock, filters included
 M-1340 Aperture diaphragm slider
 M-1341 Field diaphragm slider

DIC package

- M-1350 DIC Prism for 10x
 M-1351 DIC Prism for 20x
 M-1352 DIC Prism for 40x
 M-1353 DIC Prism for 60x
 M-1354 DIC 1 prism 10x for condenser
 M-1355 DIC 2 prism 20x-40x-60x for condenser
 M-1356 Slider with rotating analyzer

Camera Adapters

- M-620 0.35x focusable C-Mount adapter (for main photo tube only)
 M-620.1 0.5x focusable C-Mount adapter (for main photo tube only)
 M-620.2 0.65x focusable C-Mount adapter (for main photo tube only)
 M-620.3 1x focusable C-Mount adapter (for main photo tube only)
 M-1365 0.5x focusable C-Mount adapter (for left/right side photo tube only)
 M-1366 1x focusable C-Mount adapter (for left/right side photo tube only)

Miscellaneous

- M-1370 Color temperature filter, 38mm
 M-1371 Green filter, 38mm
 M-1372 Yellow filter, 38mm
 M-1373 Frosted filter, 38mm
 15104 Cleaning kit
 DC-005 TNT dust cover, extra large, 820(l)x550(h) mm
 M-005 Micrometric slide, 26x76mm, with 2 scales (1mm/100 & 10mm/100)
 VP-IM7 IQ/OQ/PQ manual for IM-7
 AB-040 Antibacterial surface treatment, only for newly purchased microscope

15104 - Cleaning kit

It cleans glass quickly and effectively, without leaving residue or odor. Ideal for precision lens or prism cleaning.



How to connect the cameras to our microscopes.

Please refer to the Adapter reference list on Digital section.

v 7.5 - OPTIKA reserves the right to make corrections, modifications, enhancements, improvements and other changes to its products at any time without notice.

Headquarters and Manufacturing Facilities

OPTIKA® S.r.l. Via Rigla, 30 - 24010 Ponteranica (BG) - ITALY - Tel.: +39 035.571.392 - info@optikamicroscopes.com

Optika Sales branches

OPTIKA® Spain spain@optikamicroscopes.com
OPTIKA® China china@optikamicroscopes.com
OPTIKA® India india@optikamicroscopes.com

OPTIKA® North America namerica@optikamicroscopes.com
OPTIKA® Central America camerica@optikamicroscopes.com
OPTIKA® Africa africa@optikamicroscopes.com

OPTIKA[®]
M I C R O S C O P E S
I T A L Y

POL Series



Routine & Research Lab Polarizing Microscopes

2 Polarized Light Microscopy

Polarized light microscopy is an optical microscopy technique involving polarized light. Simple techniques include illumination of the sample with polarized light. Directly transmitted or incident light can, optionally, be blocked with a polariser orientated at 90 degrees to the illumination.

These illumination techniques are most commonly used on birefringent samples where the polarized light interacts strongly with the sample and so generating contrast with the background. Polarized light microscopy is used extensively in optical mineralogy.

As polarised light passes through a birefringent sample, the phase difference between the fast and slow directions varies with the thickness, and wavelength of light used. The optical path difference (o.p.d.) is defined as

$$\text{o.p.d.} = \Delta n \times t$$

where t is the thickness of the sample.

This then leads to a phase difference between the light passing in the two vibration directions of

$$\delta = 2\pi (\Delta n \times t / \lambda)$$

For example, if the optical path difference is $\lambda / 2$, then the phase difference will be π , and so the polarisation will be perpendicular to the original, resulting in all of the light passing through the analyser for crossed polars.

If the optical path difference is $n \times \lambda$, then the phase difference will be $2n \times \pi$, and so the polarisation will be parallel to the original. This means that no light will be able to pass through the analyser which it is now perpendicular to.

The Michel-Levy Chart arises when polarised white light is passed through a birefringent sample. If the sample is of uniform thickness, then only one specific wavelength will meet the above condition described above, and be perpendicular to the direction of the analyser. This means that instead of polychromatic light being viewed at the analyser, one specific wavelength will have been removed. This information can be used in a number of ways:

- If the birefringence is known, then the thickness, t , of the sample can be determined
- If the thickness is known, then the birefringence of the sample can be determined

As the order of the optical path difference increases, then it is more likely that more wavelengths of light will be removed from the spectrum. This results in the appearance of the colour being "washed out", and it becomes more difficult to determine the properties of the sample. This, however, only occurs when the sample is relatively thick when compared to the wavelength of light.

Icons

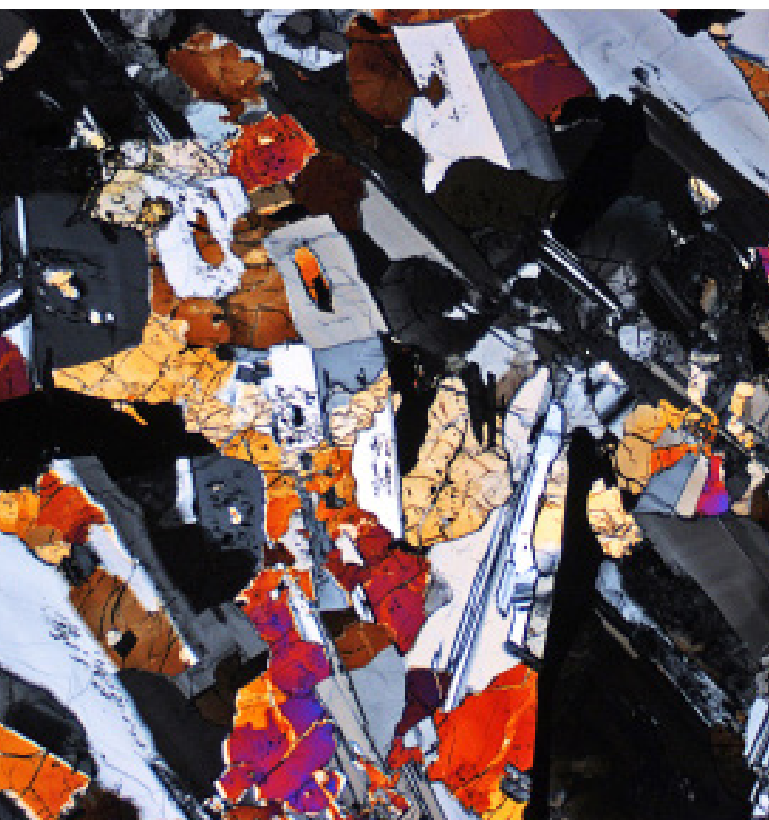

Field number



Incident light



Transmitted light



X-LED illuminator



Multi-Plug low voltage power supply



Infinity corrected optics



Polarized light



W-PLAN Objectives
(22mm field of view)



U-PLAN Objectives
(25mm field of view)

B-383POL - Polarizing Microscope

Upright microscope for brightfield and polarizing light observations with strain-free IOS N-PLAN POL objectives. Complete of polarizer and analyzer filters, Bertrand lens for conoscopic observation, compensator plates and high-precision rotatable stages. It comes with the exclusive **X-LED³** illumination system to deliver bright and clear images, along with all the accessories to perform accurate polarization analysis in biology and materials science.

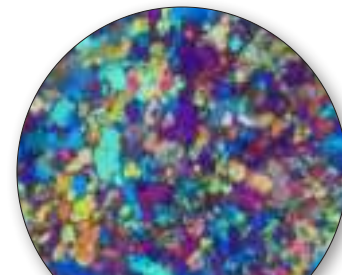

4x with First Order plate

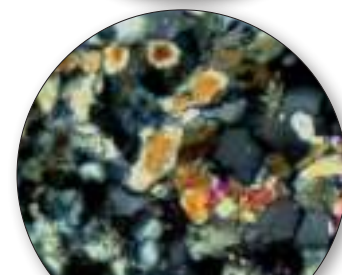

10x

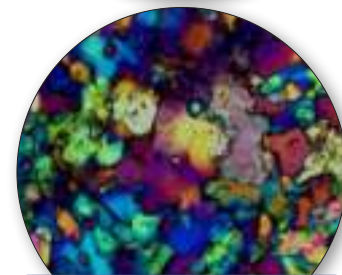

10x with First Order plate

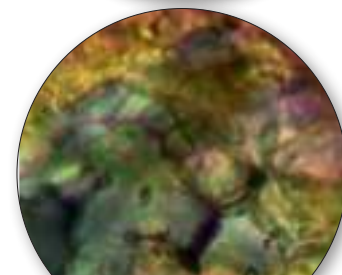

60x

Part	Description
Observation mode:	Brightfield, transmitted polarized light and conoscopy.
Bertrand lens and polarizing attachment:	Swing-out type with centering mechanism for observation in conoscopy/orthoscopy. Rotatable analyzer from 0° to 90° with graduated scale. Tint plates: 1° order red (λ); $\lambda/4$; Quartz wedge.
Head:	Trinocular (fixed 50/50), 30° inclined, 360° rotating.
Interpupillary distance:	Adjustable between 48 and 75 mm.
Dioptric adjustment:	On the left eyepiece tube.
Eyepieces:	WF10x/20 mm, high eye-point and secured by screw. One with crosshair.
Nosepiece:	Quadruple revolving nosepiece, rotation on ball bearings. Centering system for each objective.

Part	Description
Objectives (strain-free):	IOS N-PLAN POL 4x/0.10 IOS N-PLAN POL 10x/0.25 IOS N-PLAN POL 40x/0.65 IOS N-PLAN POL 60x/0.80 All with anti-fungus treatment.
Specimen stage:	Rotatable stage with locking mechanism. Vernier scale with accuracy 0.1 mm. Diameter 160 mm. Specimen slide clamps.
Focusing:	Coaxial coarse (adjustable tension) and fine focusing mechanism with limit stop to prevent the contact between objective and specimen.
Condenser:	Abbe N.A. 1.25, with objective-coded iris diaphragm, focusable and centerable. With rotating polarizing filter.
Transmitted illumination (Fixed Koehler type):	X-LED ³ with white 3.6 W LED (6.300 K) with brightness control. Multi-plug 100-240Vac/6Vdc external power supply.

B-510POL - Polarizing Microscope

Advanced routine laboratory microscope for transmitted light in brightfield and polarized light observations with strain-free IOS W-PLAN POL objectives. Complete of polarizer and analyzer filters, Bertrand lens for conoscopic observation, compensator plates and high-precision rotatable stages. It comes with the exclusive **X-LED³** illumination system to deliver bright and clear images, along with all the accessories to perform accurate polarization analysis in biology and materials science.

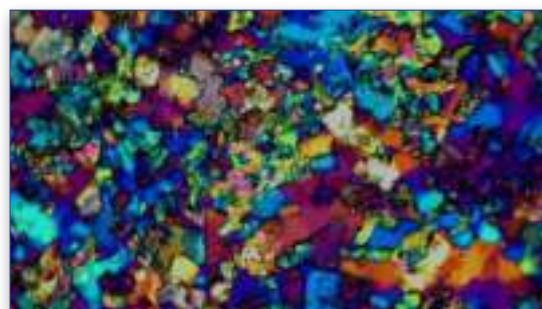

Part	Description
Observation mode:	Brightfield, transmitted polarized light and conoscopy.
Bertrand lens and polarizing attachment:	Swing-out type with centering mechanism for observation in conoscopy/orthoscopy. Rotatable analyzer from 0° to 90° with graduated scale. Tint plates: 1° order red (λ); $\lambda/4$; Quartz wedge.
Head:	Trinocular (fixed 50/50), 30° inclined, 360° rotating.
Interpupillary distance:	Adjustable between 50 and 75 mm.
Dioptric adjustment:	On the left eyepiece tube.
Eyepieces:	WF10x/22 mm, high eye-point and with rubber cups. One with crosshair.
Nosepiece:	Quadruple revolving nosepiece, rotation on ball bearings. Centering system for each objective.

Part	Description
Objectives (strain-free):	IOS W-PLAN POL 4x/0.10 IOS W-PLAN POL 10x/0.25 IOS W-PLAN POL 20x/0.45 IOS W-PLAN POL 40x/0.65 All with anti-fungus treatment.
Specimen stage:	Rotatable stage with locking mechanism and centering knobs. Vernier scale with accuracy 0.1 mm. Diameter 145 mm. Specimen slide clamps.
Focusing:	Coaxial coarse (adjustable tension) and fine focusing mechanism with limit stop to prevent the contact between objective and specimen.
Condenser:	Swing-out N.A. 0.2/0.9, with iris diaphragm, focusable and centerable. With rotating polarizing filter.
Transmitted illumination (Full Koehler type):	X-LED ³ with white 3.6 W LED (6,300 K) with brightness control. Multi-plug 100-240Vac/6Vdc external power supply.

B-510POL-I - Polarizing Microscope

Advanced routine laboratory microscope for brightfield and polarized light observations in transmitted and incident light with strain-free IOS LWD W-PLAN POL objectives. Complete of polarizer and analyzer filters, Bertrand lens for conoscopic observation, compensator plates and high-precision rotatable stages. It comes with the exclusive **X-LED³** illumination system to deliver bright and clear images, along with all the accessories to perform accurate polarization analysis in biology and materials science.

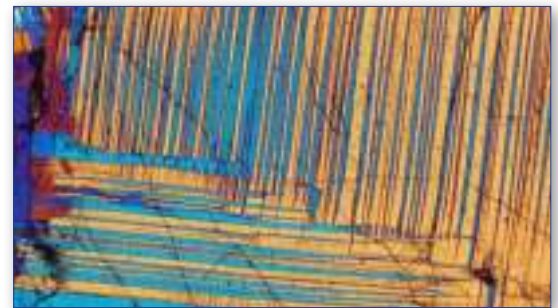

Incident/transmitted light Objectives included

Description
IOS LWD W-PLAN POL 5x/0.12, W.D. 15.5 mm
IOS LWD W-PLAN POL 10x/0.25, W.D. 10.0 mm
IOS LWD W-PLAN POL 20x/0.40, W.D. 5.8 mm
IOS LWD W-PLAN POL 50x/0.75, W.D. 0.32 mm

Part	Description
Observation mode:	Brightfield, transmitted/incident polarized light and conoscopy.
Epi-illumination and filters:	X-LED ³ with white 8 W LED (6.300 K) with brightness control. With polarizer and rotating analyzer for incident illumination, aperture and field diaphragm. With additional filter holder.
Bertrand lens and polarizing attachment:	Swing-out type with centering mechanism for observation in conoscopy/orthoscopy. Rotatable analyzer from 0° to 90° with graduated scale. Tint plates: 1° order red (λ); $\lambda/4$; Quartz wedge.
Head:	Trinocular (fixed 50/50), 30° inclined, 360° rotating.
Interpupillary distance:	Adjustable between 50 and 75 mm.
Dioptric adjustment:	On the left eyepiece tube.
Eyepieces:	WF10x/22 mm, high eye-point and with rubber cups. One with crosshair.
Nosepiece:	Quadruple revolving nosepiece, rotation on ball bearings. Centering system for each objective.

Part	Description
Objectives (strain-free):	IOS LWD W-PLAN POL 5x/0.12 IOS LWD W-PLAN POL 10x/0.25 IOS LWD W-PLAN POL 20x/0.40 IOS LWD W-PLAN POL 50x/0.75 All with anti-fungus treatment.
Specimen stage:	Rotatable stage with locking mechanism and centering knobs. Vernier scale with accuracy 0.1 mm. Diameter 145 mm. Specimen slide clamps.
Focusing:	Coaxial coarse (adjustable tension) and fine focusing mechanism with limit stop to prevent the contact between objective and specimen.
Condenser:	Swing-out N.A. 0.2/0.9, with iris diaphragm, focusable and centerable. With rotating polarizing filter.
Transmitted illumination (Full Koehler type):	X-LED ³ with white 3.6 W LED (6.300 K) with brightness control. Multi-plug 100-240Vac/6Vdc external power supply.

B-1000POL - Polarizing Microscope

The modular OPTIKA B-1000 is available with transmitted polarized light, helping you working in a comfortable way during extended periods of use and performing reliable, accurate and rapid diagnosis benefiting from modularity, which gives the chance to create customized configurations tailored on customer needs. Versatile, robust, durable and sturdy, B-1000 offers premium quality optics, the state-of-the-art, exclusive **X-LED⁸** (8 W) illumination system, designed by OPTIKA and the Koehler diaphragm.

B-1000 gives multiple options as manual or motorized configuration.



22



24



Dedicated version for transmitted
(**X-LED⁸**, 8 W)
illumination and polarization analysis.

B-1000POL - Configuration Chart

Build the microscope that suites your needs by choosing among the components

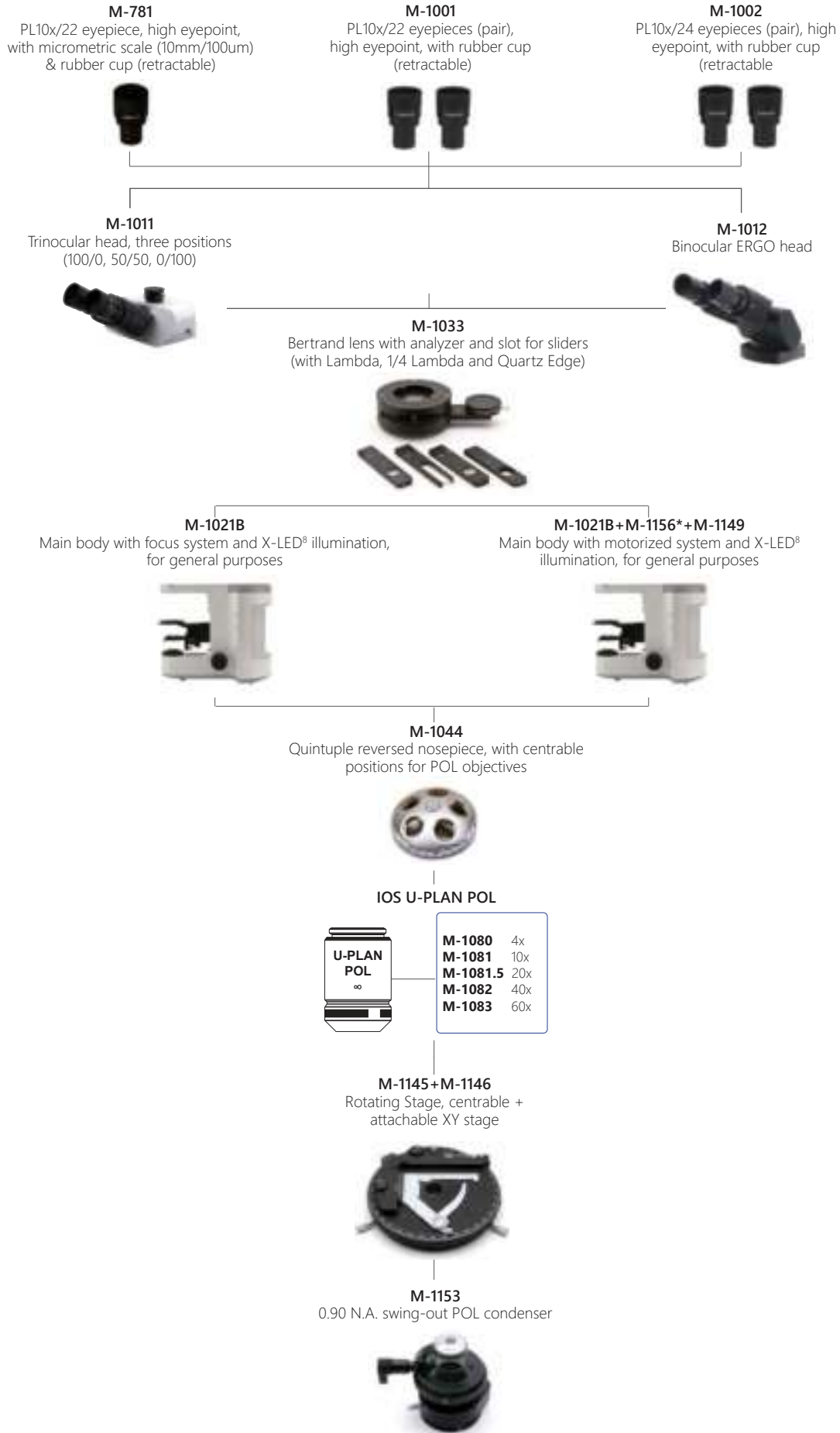

* Code M-1156 must be added only **once** for any motorized configuration

2 B-1000POL-I - Polarizing Microscope

The modular OPTIKA B-1000 is available with transmitted and incident polarized light, helping you working in a comfortable way during extended periods of use and performing reliable, accurate and rapid diagnosis benefiting from modularity, which gives the chance to create customized configurations tailored on customer needs. Versatile, robust, durable and sturdy, B-1000 offers premium quality optics, the state-of-the-art, exclusive **X-LED[®]** (8 W) illumination system, designed by OPTIKA and the Koehler diaphragm. B-1000 gives multiple options as manual or motorized configuration.



Dedicated version for transmitted and incident illumination (**X-LED[®]**, 8 W)



B-1000POL-I - Configuration Chart

Build the microscope that suites your needs by choosing among the components

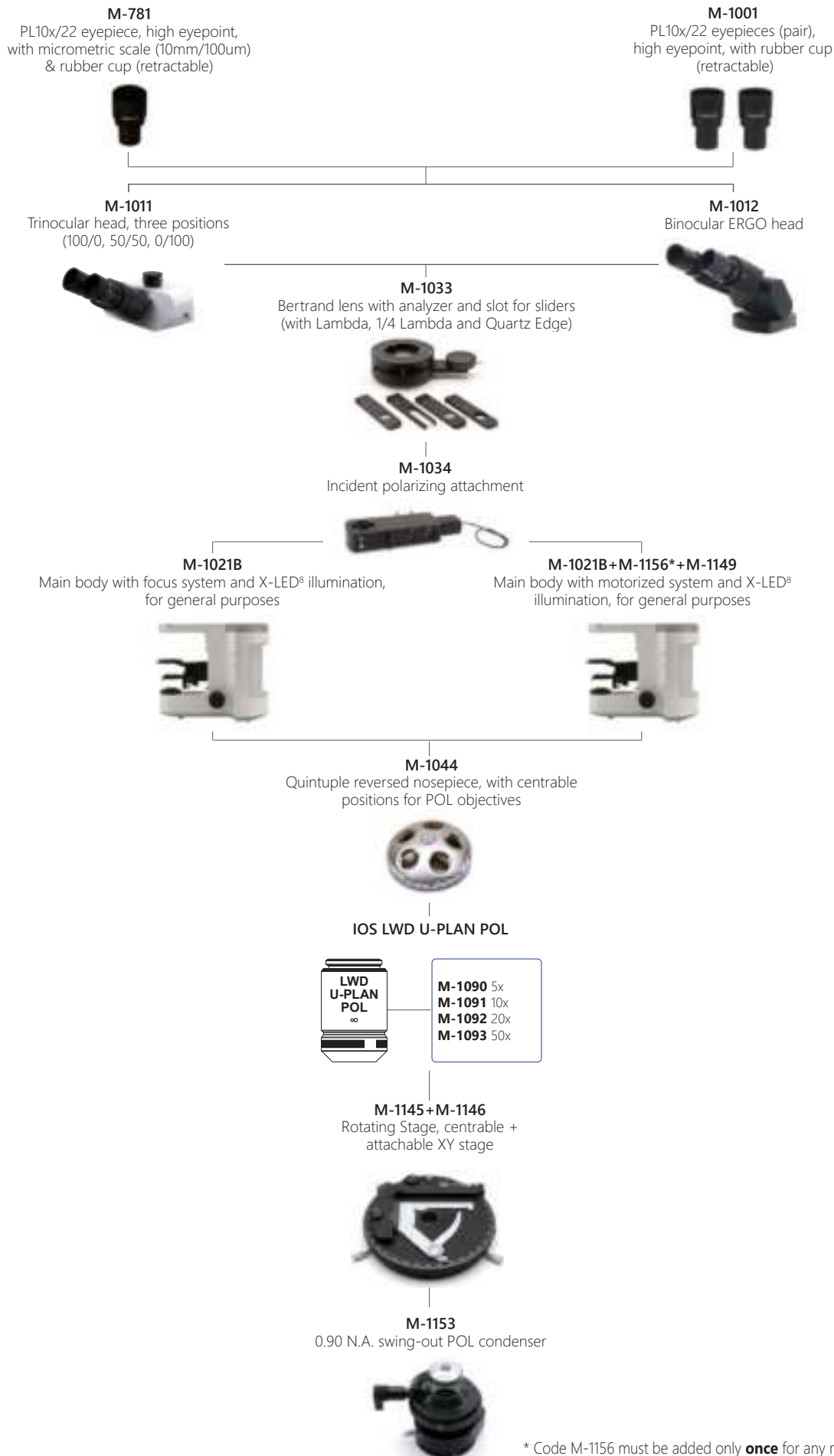

* Code M-1156 must be added only **once** for any motorized configuration

v 7.5 - OPTIKA reserves the right to make corrections, modifications, enhancements, improvements and other changes to its products at any time without notice.

Headquarters and Manufacturing Facilities

OPTIKA® S.r.l. Via Rigla, 30 - 24010 Ponteranica (BG) - ITALY - Tel.: +39 035.571.392 - info@optikamicroscopes.com

Optika Sales branches

OPTIKA® Spain spain@optikamicroscopes.com

OPTIKA® China china@optikamicroscopes.com

OPTIKA® India india@optikamicroscopes.com

OPTIKA® North America namerica@optikamicroscopes.com

OPTIKA® Central America camerica@optikamicroscopes.com

OPTIKA® Africa africa@optikamicroscopes.com

OPTIKA[®]
M I C R O S C O P E S
I T A L Y

FLUO Series



Routine & Research Lab Fluorescence Microscopes

Epi Fluorescence microscopes













A fluorescence microscope is an optical microscope that uses fluorescence and phosphorescence instead of, or in addition to, reflection and absorption to study properties of organic or inorganic substances. The "fluorescence microscope" refers to any microscope that uses fluorescence to generate an image. The Epi Fluorescence microscope is equipped with a fluorescence illuminator which generates incident fluorescence light.

Principle

The specimen is illuminated with light of a specific wavelength (or wavelengths) which is absorbed by the fluorophores, causing them to emit light of longer wavelengths (i.e., of a different color than the absorbed light). The illumination light is separated from the much weaker emitted fluorescence through the use of a spectral emission filter. Typical components of a fluorescence microscope are a light source (HBO mercury-vapor lamps are common; more advanced forms are high-power LEDs), the excitation filter, the dichroic mirror, and the emission filter. The filters and the dichroic mirror are chosen to match the spectral excitation and emission characteristics of the fluorophore used to label the specimen. In this manner, the distribution of a single fluorophore (color) is imaged at a time. Multi-color images of several types of fluorophores must be composed by combining several single-color images.

Most fluorescence microscopes in use are epifluorescence microscopes, where excitation of the fluorophore and detection of the fluorescence are done through the same light path (through the objective). These microscopes are widely used in biology and are the basis for more advanced microscope designs.

Icons

	Field number		Transmitted light		Infinity corrected optics
	Oil/Water 100x objective		X-LED illuminator		Fluorescence
	Incident light		Multi-Plug low voltage power supply		Phase contrast
	N-PLAN Objectives (20mm field of view)		W-PLAN Objectives (22mm field of view)		U-PLAN Objectives (25mm field of view)

Fluorescence Microscopy

Epifluorescence microscopy

The majority of fluorescence microscopes, especially those used in the life sciences, are of the epifluorescence design. Light of the excitation wavelength illuminates the specimen through the objective lens. The fluorescence emitted by the specimen is focused to the detector by the same objective that is used for the excitation which for greater resolution will need objective lens with higher numerical aperture. Since most of the excitation light is transmitted through the specimen, only reflected excitatory light reaches the objective together with the emitted light and the epifluorescence method therefore gives a high signal-to-noise ratio. The dichroic beamsplitter acts as a wavelength specific filter, transmitting fluoresced light through to the eyepiece or detector, but reflecting any remaining excitation light back towards the source.

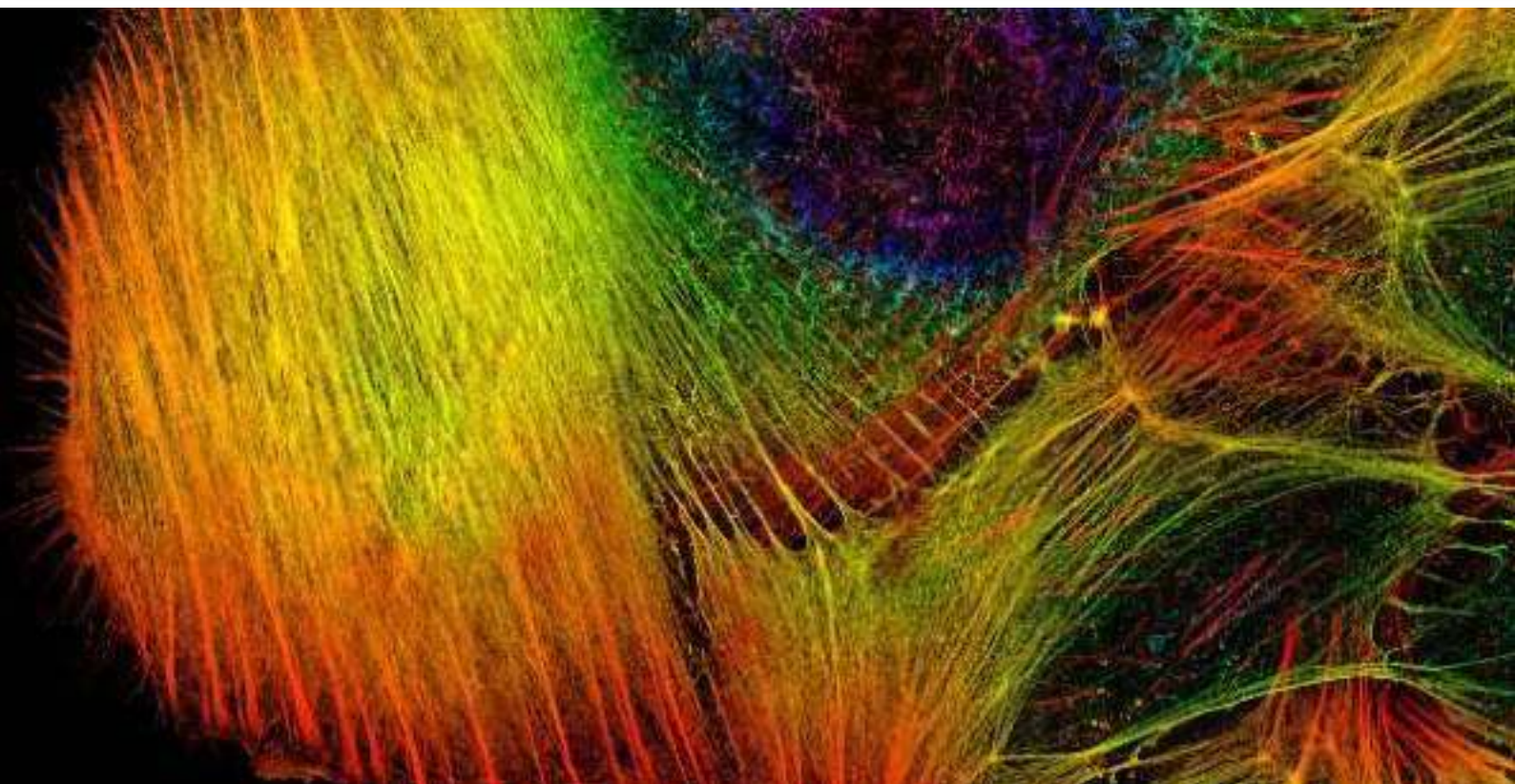

B-290LD - LED Fluorescence Microscopes



Fluorescence binocular and trinocular microscopes especially designed for tuberculosis and malaria analysis.

Observation mode: Brightfield.

Head: Binocular or trinocular, 360° rotating and 30° inclined. Interpupillary distance 48-75mm (bino version) 55-75mm (trino version).

Dioptric adjustment: On the left eyepiece tube.

Eyepieces: WF10x/20 mm, high eye-point and secured by a screw.

Nosepiece: Quadruple revolving nosepiece, rotation on ball bearings.

Specimen stage: Double layer rackless mechanical sliding stage, 150x139 mm, 75x33 mm X-Y movement range. Vernier scale on the two axes, accuracy: 0.1 mm.

Focusing: Coaxial coarse and fine focusing mechanism with limit stop to prevent the contact between objective and specimen. Adjustable tension of coarse focusing knob.

Condenser: Abbe N.A. 1.25, with objective-coded iris diaphragm, focusable and centerable.

Brightfield Illumination (Fixed Koehler type): X-LED³ with white 3.6 W LED (6,300 K) and light intensity control.

Multi-plug 100-240Vac/6Vdc external power supply.

Fluorescence Illumination: Extra efficiency LED, with light intensity control. Peak wavelength: 465 nm, Power: 3.6W.

Epi Fluorescence Attachment: Slider with 3 positions (2 fluorescence, 1 brightfield), with 1 included filterset: Fluorescence B: EX 460-490, DM 505, EM 515LP: Acridine Yellow, Acridine Orange, Auramine, DiO, DTAF, FITC, GFP, YFP, etc.

Part number: B-292LD1.50

Equipped with binocular head and following objectives:
 IOS N-PLAN 10x/0.25 (Cover/No Cover), with anti-fungus treatment
 IOS N-PLAN 20x/0.40 (Cover/No Cover), with anti-fungus treatment
 IOS N-PLAN 40x/0.65 (Cover/No Cover), with anti-fungus treatment
 IOS W-PLAN MET 50x/0.75 (No Cover), with anti-fungus treatment.

Part number: B-293LD1.50

Trinocular version of B-292LD1.50.

Part number: B-292LD1

Equipped with binocular head and following objectives:
 IOS N-PLAN 10x/0.25 (Cover/No Cover), with anti-fungus treatment
 IOS N-PLAN 20x/0.40 (Cover/No Cover), with anti-fungus treatment
 IOS N-PLAN 40x/0.65 (Cover/No Cover), with anti-fungus treatment
 IOS W-PLAN 100x/0.80 (No Cover, Dry), with anti-fungus treatment.

Part number: B-293LD1

Trinocular version of B-292LD1.

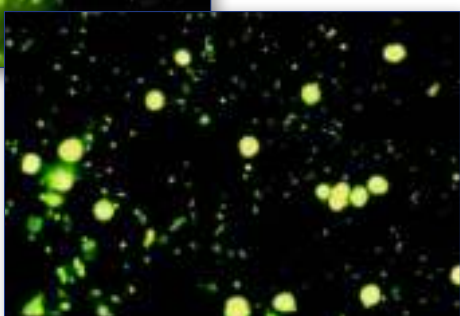
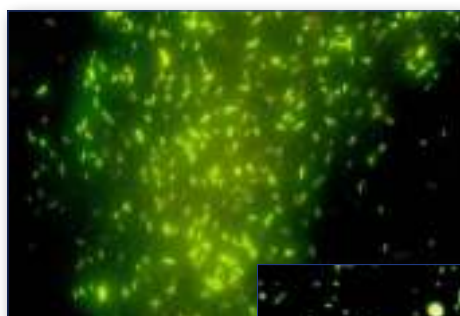

Standard filterset

Name	Excitation filter (nm)	Dichroic mirror cut-off (nm)	Emission filter (nm)
B (Blue)	460 – 490	505	515LP

B-383FL - HBO Fluorescence Microscope

Laboratory upright microscope for brightfield and fluorescence observations with IOS N-PLAN objectives.

The HBO fluorescence illuminator provides an outstanding flexibility of use, standing the blue and green filter sets (supplied as standard) for Auramine, FITC, GFP and YFP (with blue filter set) plus Rhodamine, Texas Red and TRITC (with the green one), yet giving the possibility to combine any other specific filter sets for future upgrade. Transmitted light through the exclusive **X-LED³** to ensure great-looking, rich and high-quality specimen view.

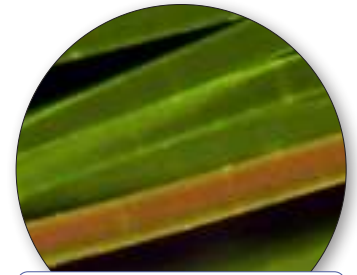

10x - Blue excitation



10x - Green excitation

Standard filterset

Name	Excitation filter (nm)	Dichroic mirror cut-off (nm)	Emission filter (nm)
B Blue	460 – 490	505	515LP
G Green	510 – 550	570	575LP



Part	Description
Observation mode:	Brightfield, HBO fluorescence.
Epi-illumination and filters:	HBO 100 W high pressure mercury lamp. 3-position filter holder; blue and green included.
Head:	Trinocular (fixed 50/50), 30° inclined, 360° rotating.
Interpupillary distance:	Adjustable between 48 and 75 mm.
Dioptric adjustment:	On the left eyepiece tube.
Eyepieces:	WF10x/20 mm, high eye-point and secured by screw.
Nosepiece:	Quintuple revolving nosepiece, rotation on ball bearings.
Objectives:	IOS N-PLAN 4x/0.10 IOS N-PLAN 10x/0.25 IOS N-PLAN 20x/0.40 IOS N-PLAN 40x/0.65 IOS N-PLAN 100x/1.25 (Oil/Water) All with anti-fungus treatment.

Part	Description
Specimen stage:	Double layer rackless mechanical stage, 233x147 mm, 78x54 mm X-Y range.
Focusing:	Coaxial coarse (adjustable tension) and fine focusing mechanism with limit stop to prevent the contact between objective and specimen.
Condenser:	Abbe N.A. 1.25, with objective-coded iris diaphragm, focusable and centerable.
Transmitted illumination (Fixed Koehler type):	X-LED ³ with white 3.6 W LED (6,300K) with brightness control. Multi-plug 100-240Vac/6Vdc external power supply.

B-383LD - LED Fluorescence Microscope

Entry-level laboratory upright microscope for brightfield and fluorescence observations with IOS N-PLAN objectives. The extremely powerful LED fluorescence illuminator is combined with blue excitation filter set for the visualization of the following fluorochromes: Acridine Yellow, Acridine Orange, Auramine, DiO, DTAF, FITC, GFP, YFP, etc. LED fluorescence ensures unparalleled convenience eliminating warm-up/cool-down times and all the inconveniences related lamp replacement and adjustment. Transmitted light through the exclusive **X-LED³** to ensure great-looking, rich and high-quality specimen view.



4x

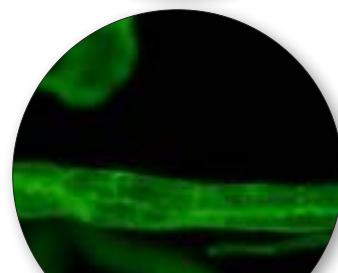

10x

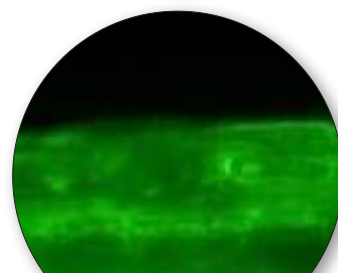

40x

Standard filterset

Name	Excitation filter (nm)	Dichroic mirror cut-off (nm)	Emission filter (nm)
B Blue	460 – 490	505	515LP

Part	Description
Observation mode:	Brightfield, LED fluorescence.
Epi-illumination and filter:	High-power blue LED with brightness control. 3-position filter holder; blue included.
Head:	Trinocular (fixed 50/50), 30° inclined, 360° rotating.
Interpupillary distance:	Adjustable between 48 and 75 mm.
Dioptric adjustment:	On the left eyepiece tube.
Eyepieces:	WF10x/20 mm, high eye-point and secured by screw.
Nosepiece:	Quintuple revolving nosepiece, rotation on ball bearings.
Objectives:	4x/0.10, W.D. 16.8 mm 10x/0.25, W.D. 5.8 mm 20x/0.40, W.D. 5.1 mm 40x/0.65, W.D. 0.43 mm 100x/1.25 (Oil/Water), W.D. 0.13 mm All with anti-fungus treatment.

Part	Description
Specimen stage:	Double layer rackless mechanical stage, 233x147 mm, 78x54 mm X-Y range.
Focusing:	Coaxial coarse (adjustable tension) and fine focusing mechanism with limit stop to prevent the contact between objective and specimen.
Condenser:	Abbe N.A. 1.25, with objective-coded iris diaphragm, focusable and centerable.
Transmitted illumination (Fixed Koehler type):	X-LED ³ with white 3.6 W LED (6,300K) with brightness control. Multi-plug 100-240Vac/6Vdc external power supply.

B-510FL - HBO Fluorescence Microscope

Advanced routine laboratory microscope for brightfield and fluorescence observations with Semi-Apo IOS W-PLAN F objectives to enhance the visibility of the sample and increase the overall contrast. The **HBO fluorescence** illuminator provides an outstanding flexibility of use, standing the blue and green filter sets (supplied as standard) for Auramine, FITC, GFP and YFP (with blue filter set) plus Rhodamine, Texas Red and TRITC (with the green one), yet giving the possibility to combine any other specific filter sets for future upgrade. Transmitted light through the exclusive **X-LED³** to ensure great-looking, rich and high-quality specimen view.

-  22
- 
- 
- 
- 
- 
- 

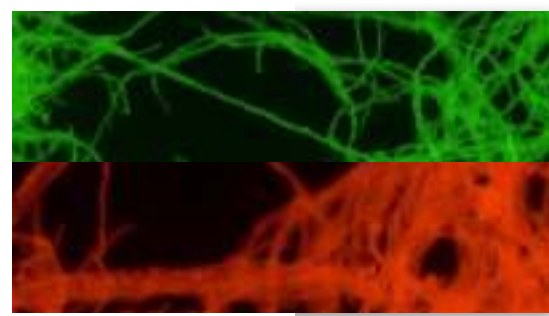

Standard filterset

Name	Excitation filter (nm)	Dichroic mirror cut-off (nm)	Emission filter (nm)
B Blue	460 - 490	505	515LP
G Green	510 - 550	570	575LP

Additional filterset (optional)

Name	Excitation filter (nm)	Dichroic mirror cut-off (nm)	Emission filter (nm)
V (Violet)	390 - 420	440	455LP
UV	325 - 375	415	435LP

Part	Description
Observation mode:	Brightfield, HBO fluorescence.
Epi-illumination and filter:	HBO 100 W high pressure mercury lamp. 4-position filter holder; blue & green included.
Head:	Trinocular (3-position 100/0, 50/50, 0/100), 30° inclined, 360° rotating.
Interpupillary distance:	Adjustable between 50 and 75 mm.
Dioptric adjustment:	On the left eyepiece tube.
Eyepieces:	WF10x/22 mm, high eye-point and with rubber cups.
Nosepiece:	Quintuple revolving nosepiece, rotation on ball bearings.
Objectives:	IOS W-PLAN F 4x/0.13 IOS W-PLAN F 10x/0.30 IOS W-PLAN F 20x/0.50 IOS W-PLAN F 40x/0.75 All with anti-fungus treatment.

Part	Description
Specimen stage:	Double layer rackless mechanical stage, 233x147 mm, 78x54 mm X-Y range.
Focusing:	Coaxial coarse (adjustable tension) and fine focusing mechanism with limit stop to prevent the contact between objective and specimen.
Condenser:	Swing-out N.A. 0.2/0.9, with iris diaphragm, focusable and centerable.
Transmitted illumination (Full Koehler type):	X-LED ³ with white 3.6 W LED (6,300K) with brightness control. Multi-plug 100-240Vac/6Vdc external power supply.

B-510LD4 - LED Fluorescence Microscope

Advanced routine fluorescence microscope for transmitted brightfield and fluorescence observations with IOS W-PLAN objectives. The extremely powerful LED Fluorescence Illuminators are combined with corresponding excitation filter sets for the visualization of most fluorochromes. LED fluorescence ensures unparalleled convenience eliminating warm-up/cool-down times and all the inconveniences related lamp replacement and adjustment. Transmitted light through the exclusive **X-LED³** to ensure great-looking, rich and high-quality specimen view.

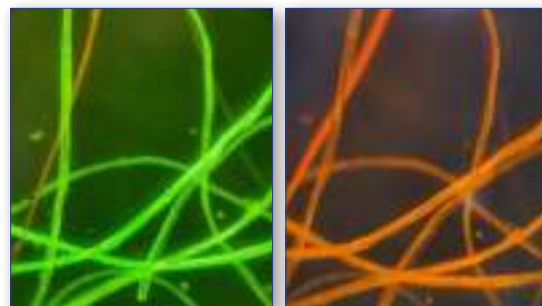

A new milestone achieved in Fluorescence Microscopy

- » Full-modular Fluorescence System
- » Interchangeable LED-Filtersets
- » 4 LED-Filtersets slots
- » 10% higher light intensity than HBO
- » 35% higher light intensity than Metal-Halide
- » Adjustable light intensity
- » The selection of filtersets automatically involves the switching on of the corresponding LEDs
- » Cost-effective, money saving technology
- » Ready for immediate operation
- » Eliminate warm-up/cool-down times
- » Forget lamp replacement & centering

Part	Description
Observation mode:	Brightfield, LED fluorescence.
Epi-illumination and filter:	High-power LED with brightness control. 4-position filter holder; none included.
Head:	Trinocular (3-position 100/0, 50/50, 0/100), 30° inclined, 360° rotating.
Interpupillary distance:	Adjustable between 50 and 75 mm.
Dioptric adjustment:	On the left eyepiece tube.
Eyepieces:	WF10x/22 mm, high eye-point and with rubber cups.
Nosepiece:	Quintuple revolving nosepiece, rotation on ball bearings.
Object.: B-510LD4:	IOS W-PLAN 4x/0.10 IOS W-PLAN 10x/0.25 IOS W-PLAN 40x/0.65 IOS W-PLAN 100x/1.25 (Oil)
B-510LD4-SA:	IOS W-PLAN F 4x/0.13 IOS W-PLAN F 10x/0.30 IOS W-PLAN F 40x/0.75 IOS W-PLAN F 100x/1.3 (Oil)
	All with anti-fungus treatment.

Part	Description
Specimen stage:	Double layer rackless mechanical stage, 233x147 mm, 78x54 mm X-Y range.
Focusing:	Coaxial coarse (adjustable tension) and fine focusing mechanism with limit stop to prevent the contact between objective and specimen.
Condenser:	Swing-out N.A. 0.2/0.9, with iris diaphragm, focusable and centerable.
Transmitted illumination (Full Koehler type):	X-LED ³ with white 3.6 W LED (6,300K) with brightness control. Multi-plug 100-240Vac/6Vdc external power supply.

B-510LD4 - LED Fluorescence Microscope



OPTIKA LED Fluorescence attachment is a revolutionary solution. It consists of a 4-position selector for the use of 4 fluorescent illuminators, called LED Fluorescence Cubes. Each Cube is composed of a filterset mounted on a filterblock and a high power LED with emission corresponding to the filters installed. In this way the selection of each filter controls the lighting up of the corresponding LED.

The microscope is supplied without any LED Fluorescence Cube. A selection of 9 types is available, as shown in the table below.

B-510LD4
Trinocular brightfield microscope, 1000x,
IOS W-PLAN objectives

B-510LD4-SA
Trinocular brightfield microscope, 1000x,
IOS W-PLAN F (Semi-Apo) objectives. **For UV Fluorescence**



M-1220 ... M-1228
LED Fluorescence Cubes (LED + Filterset)

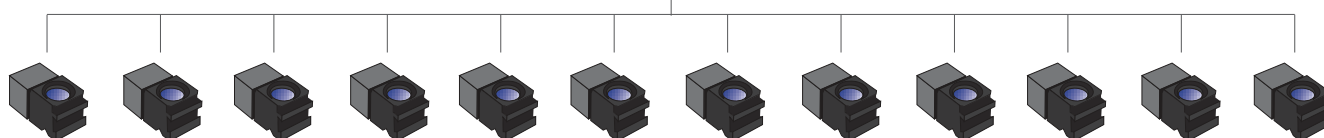

LED Fluorescence Cubes available (LED + Filterset)

Name	LED emission (nm)	Excitation filter (nm)	Dichroic mirror cut-off (nm)	Emission filter (nm)
M-1220 - Blue	460	455 - 495	500	510LP
M-1220.1 - Blue (pass band)	460	455 - 495	500	518-542
M-1221 - Green	523	510 - 550	570	575LP
M-1221.1 - Green (pass band)	523	510 - 550	570	585-625
M-1222 - Violet	405	390 - 420	440	450LP
M-1223 - UV	365	325 - 375	415	435LP
M-1223.1 - UV (pass band)	365	340 - 390	405	420-470
M-1224 - Red 1 *	623	590 - 650	660	665LP
M-1225 - Red 2 *	623	595 - 645	655	665 - 715
M-1226 - Deep Red *	660	623 - 678	685	690 - 750
M-1227 - Far Red *	740	720 - 760	770	780LP
M-1228 - Amber	590	582 - 603	610	615 - 645

* If the use of a camera is needed, when used for red emission fluorescence wavelengths above 650nm, please order OPTIKA camera code C-P6AR.

2 B-1000FL-HBO - HBO Fluorescence Microscope

The modular OPTIKA B-1000 can stand a HBO fluorescence attachment, helping you working in a comfortable way during extended periods of use and performing reliable, accurate and rapid diagnosis benefiting from modularity, which gives the chance to create customized configurations tailored on customer needs. Versatile, robust, durable and sturdy, B-1000 offers premium quality optics (including Semi-Apo objectives), the state-of-the-art, exclusive **X-LED⁸** (8 W) illumination system, designed by OPTIKA and the Koehler diaphragm. B-1000 gives multiple options as manual or motorized configuration, with a variety of objectives, stages and condensers.

Standard filterset

Name	Excitation filter (nm)	Dichroic mirror cut-off (nm)	Emission filter (nm)
B Blue	460 - 490	500	520LP
G Green	510 - 550	570	590LP

Additional filterset (optional)

Name	Excitation filter (nm)	Dichroic mirror cut-off (nm)	Emission filter (nm)
V (Violet)	400 - 410	455	455LP
UV	330 - 385	400	420LP



B-1000FL-HBO - Configuration Chart

Build the microscope that suites your needs by choosing among the components



* Code M-1156 must be added only **once** for any motorized configuration

2 B-1000LD4 - LED Fluorescence Microscope

The modular OPTIKA B-1000 can stand a LED fluorescence attachment, helping you working in a comfortable way during extended periods of use and performing reliable, accurate and rapid diagnosis benefiting from modularity, which gives the chance to create customized configurations tailored on customer needs. Versatile, robust, durable and sturdy, B-1000 offers premium quality optics (including Apo and Semi-Apo objectives), the state-of-the-art, exclusive **X-LED³** (8 W) illumination system, designed by OPTIKA and the Koehler diaphragm. B-1000 gives multiple options as manual or motorized configuration, with a variety of objectives, stages and condensers.

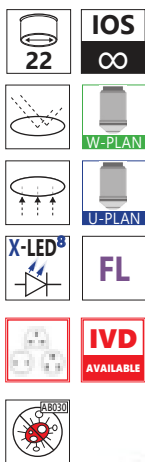

A new milestone achieved in Fluorescence Microscopy

- » Full-modular Fluorescence System
- » Interchangeable LED-Filtersets
- » 4 LED-Filtersets slots
- » 10% higher light intensity than HBO
- » 35% higher light intensity than Metal-Halide
- » Adjustable light intensity
- » The selection of filtersets automatically involves the switching on of the corresponding LEDs
- » Recommended for research applications
- » Cost-effective, money saving technology
- » Ready for immediate operation
- » Eliminate warm-up/cool-down times
- » Forget lamp replacement & centering

LED Fluorescence Cubes available (LED + Filterset)

Name	LED emission (nm)	Excitation filter (nm)	Dichroic mirror cut-off (nm)	Emission filter (nm)
M-1220 - Blue	460	455 - 495	500	510LP
M-1220.1 - Blue (pass band)	460	455 - 495	500	518-542
M-1221 - Green	523	510 - 550	570	575LP
M-1221.1 - Green (pass band)	523	510 - 550	570	585-625
M-1222 - Violet	405	390 - 420	440	450LP
M-1223 - UV	365	325 - 375	415	435LP
M-1223.1 - UV (pass band)	365	340 - 390	405	420-470
M-1224 - Red 1 *	623	590 - 650	660	665LP
M-1225 - Red 2 *	623	595 - 645	655	665 - 715
M-1226 - Deep Red *	660	623 - 678	685	690 - 750
M-1227 - Far Red *	740	720 - 760	770	780LP
M-1228 - Amber	590	582 - 603	610	615 - 645

* If the use of a camera is needed, when used for red emission fluorescence wavelengths above 650nm, please order OPTIKA camera code C-P6AR.

B-1000LD4 - Configuration Chart

Build the microscope that suites your needs by choosing among the components



* Code M-1156 must be added only **once** for any motorized configuration

Fluorescence Filtersets

Name	Excitation filter (nm)	Dichroic mirror cut-off (nm)	Emission filter (nm)
B (Blue)	460 – 490	505	515LP
G (Green)	510 – 550	570	575LP
V (Violet) optional	385 – 425	440	455LP
UV (Ultraviolet) optional	325 – 375	415	435LP

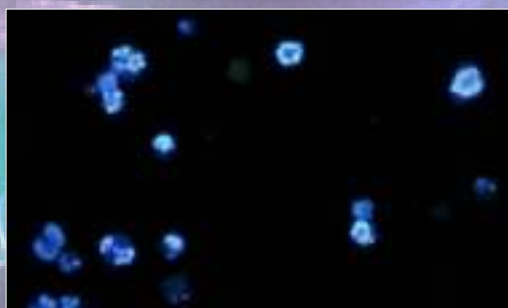
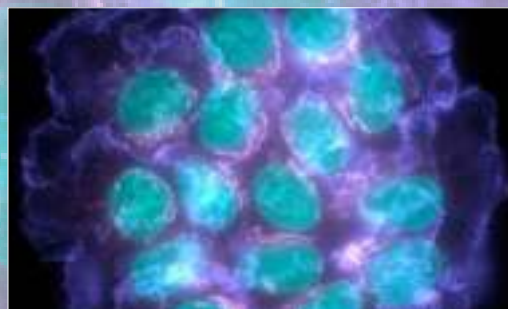
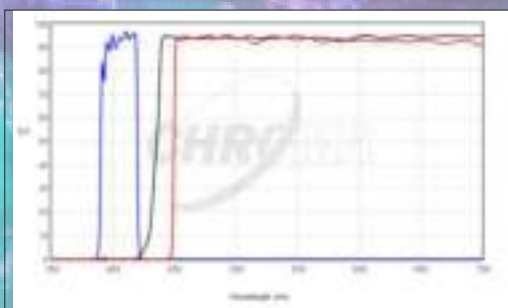
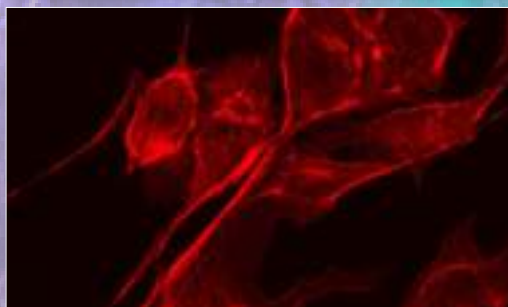
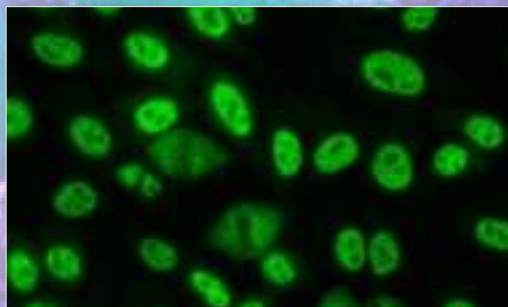

**MANY MORE FILTERSETS
AVAILABLE ON REQUEST**

CHROMA TECHNOLOGY CORP
THE WORLD'S FINEST OPTICAL FILTERS

Specs are of B-510FL Filtersets

IM-300F - HBO Fluorescence Microscope

Routine inverted fluorescence microscope for transmitted brightfield, phase contrast and fluorescence observations with IOS LWD W-PLAN objectives. The HBO fluorescence illuminator is combined with blue and green excitation filter set for the visualization of the following fluorochromes: Ethidium Bromide, Acridine Orange, Alexa Fluor 488, Fluo-4, FITC Plus, Spectrum Green, Ethidium Homodimer I, Propidium Iodide (PI) and Spectrum Gold. Transmitted light through the exclusive **X-LED[®]** to ensure great-looking, rich and high-quality specimen view.



Standard filtersets

Name	Excitation filter (nm)	Dichroic mirror cut-off (nm)	Emission filter (nm)
B (Blue)	465 – 495	505	515LP
G (Green)	527 – 553	565	575LP

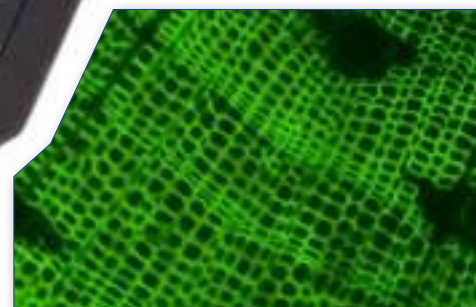

Part	Description
Observation mode:	Brightfield, phase contrast, HBO fluorescence.
Epi-illumination and filter:	HBO 100 W high pressure mercury lamp. 3-position filter holder; blue & green included.
Head:	Trinocular (2-position 100/0, 0/100), 45° inclined.
Interpupillary distance:	Adjustable between 50 and 75 mm.
Diopter adjustment:	On the left eyepiece tube.
Eyepieces:	WF10x/22 mm, high eye-point and with rubber cups.
Nosepiece:	Quintuple revolving nosepiece, rotation on ball bearings.
Objectives:	IOS LWD W-PLAN PH 10x/0.25 IOS LWD W-PLAN PH 20x/0.40 IOS LWD W-PLAN PH 40x/0.65 All with anti-fungus treatment.

Part	Description
Specimen stage:	Fixed stage, 250x290 mm, with round glass and metal stage inserts for slides and 54mm dia. Petri dishes.
Focusing:	Coaxial coarse (adjustable tension) and fine focusing mechanism.
Condenser:	LWD pre-centered condenser, N.A. 0.30, W.D. 72 mm. With 4x/10x, 20x/40x phase contrast slider and brightfield. Supplied with blue (LBD) and green filter.
Transmitted illumination:	X-LED [®] with white 8 W LED (6,300K) with brightness control. With aperture diaphragm. Multi-plug 100-240Vac/6Vdc external power supply.

IM-300FL4 - HBO Fluorescence Microscope

Advanced inverted microscope for brightfield and fluorescence observations with Semi-Apo IOS LWD U-PLAN F objectives to enhance the visibility of the sample and increase the overall contrast. The HBO fluorescence illuminator provides an outstanding flexibility of use, standing the blue and green filter sets (supplied as standard) for Ethidium Bromide, Acridine Orange, Alexa Fluor 488, Fluo-4, FITC Plus, Spectrum Green, Ethidium Homodimer I, Propidium Iodide (PI) and Spectrum Gold, with additional filterset: Alexa Fluor 350, Aminocoumarin, Hoechst, DAPI, BFP (Blue Fluorescent Protein), Atto 390, Tetracycline, Pacific Orange and Spectrum Blue. Transmitted light through the exclusive **X-LED[®]** to ensure great-looking, rich and high-quality specimen view.



Standard filterset

Name	Excitation filter (nm)	Dichroic mirror cut-off (nm)	Emission filter (nm)
B Blue	465 - 495	505	515LP
G Green	527 - 553	565	575LP

Additional filterset (optional)

Name	Excitation filter (nm)	Dichroic mirror cut-off (nm)	Emission filter (nm)
V (Violet)	390 - 420	440	455LP
UV	325 - 375	415	435LP



Part	Description
Observation mode:	Brightfield, HBO fluorescence.
Epi-illumination and filter:	HBO 100 W high pressure mercury lamp. 4-position filter holder; blue & green included.
Head:	Trinocular (2-position 100/0, 0/100), 45° inclined.
Interpupillary distance:	Adjustable between 50 and 75 mm.
Diopter adjustment:	On the left eyepiece tube.
Eyepieces:	WF10x/22 mm, high eye-point and with rubber cups.
Nosepiece:	Quintuple revolving nosepiece, rotation on ball bearings.
Objectives:	IOS LWD U-PLAN F 10x/0.30 IOS LWD U-PLAN F 20x/0.45 IOS LWD U-PLAN F 40x/0.65 All with anti-fungus treatment.

Part	Description
Specimen stage:	Fixed stage, 250x290 mm, with round glass and metal stage inserts for slides and 54mm dia. Petri dishes.
Focusing:	Coaxial coarse (adjustable tension) and fine focusing mechanism.
Condenser:	LWD pre-centered condenser, N.A. 0.30, W.D. 72 mm. Supplied with blue (LBD) filter.
Transmitted illumination:	X-LED [®] with white 8 W LED (6,300K) with brightness control. With aperture diaphragm. Multi-plug 100-240Vac/6Vdc external power supply.

IM-300LD2 - LED Fluorescence Microscope

Routine inverted fluorescence microscope for transmitted brightfield, phase contrast and fluorescence observations with IOS LWD W-PLAN PH objectives. The LED fluorescence illuminators are combined with blue and green excitation filter set for the visualization of the following fluorochromes: GFP, Alexa Fluor 488, Calcein, SYBR Green, FITC, Fluo-4, MitoTracker Green, Spectrum Gold, Propidium Iodide, Ethidium Homodimer I. LED fluorescence ensures unparalleled convenience eliminating warm-up/cool-down times and all the inconveniences related lamp replacement and adjustment. Transmitted light through the exclusive **X-LED[®]** to ensure great-looking, rich and high-quality specimen view.

-  22
- 
- 
- 
- 
- 
- 
- 
- 
- 
- 

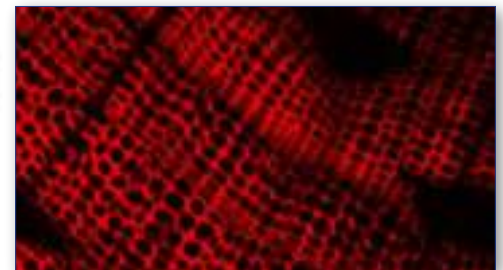
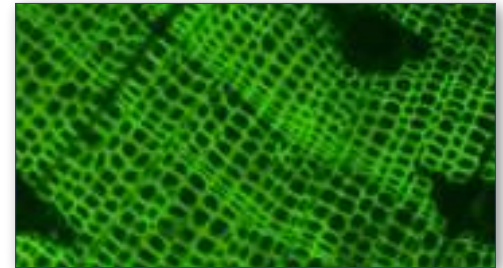

A new milestone achieved in Fluorescence Microscopy

- » 10% higher light intensity than HBO
- » 35% higher light intensity than Metal-Halide
- » Adjustable light intensity
- » The selection of filtersets automatically involves the switching on of the corresponding LEDs
- » Recommended for routine applications
- » Cost-effective, money saving technology
- » Ready for immediate operation
- » Eliminate warm-up/cool-down times
- » Forget lamp replacement & centering

LED Fluorescence Cubes (LED + Filterset) included

Name	LED emission (nm)	Excitation filter (nm)	Dichroic mirror cut-off (nm)	Emission filter (nm)
Blue	460	455 - 495	500	510LP
Green	523	510 - 550	570	575LP

Part	Description
Observation mode:	Brightfield, phase contrast, LED fluorescence.
Epi-illumination and filter:	High-power LED with brightness control. 3-position filter holder; blue and green filtersets included.
Head:	Trinocular (2-position 100/0, 50/50), 45° inclined.
Interpupillary distance:	Adjustable between 50 and 75 mm.
Diopter adjustment:	On the left eyepiece tube.
Eyepieces:	WF10x/22 mm, high eye-point and with rubber cups.
Nosepiece:	Quintuple revolving nosepiece, rotation on ball bearings.
Objectives:	IOS LWD W-PLAN PH 10x/0.25 IOS LWD W-PLAN PH 20x/0.40 IOS LWD W-PLAN PH 40x/0.65 All with anti-fungus treatment.

Part	Description
Specimen stage:	Fixed stage, 250x290 mm, with round glass and metal stage inserts for slides and 54mm dia. Petri dishes.
Focusing:	Coaxial coarse (adjustable tension) and fine focusing mechanism.
Condenser:	LWD pre-centered condenser, N.A. 0.30, W.D. 72 mm. With 4x/10x, 20x/40x phase contrast slider and brightfield.
Transmitted illumination:	X-LED [®] with white 8 W LED (6,300K) with brightness control. With aperture diaphragm. 100-240Vac/12Vdc external power supply.

IM-300LD4 - LED Fluorescence Microscope

Advanced fluorescence inverted microscope for transmitted brightfield and fluorescence observations with IOS LWD U-PLAN F objectives. The extremely powerful LED Fluorescence Illuminators are combined with corresponding excitation filter sets for the visualization of most fluorochromes. LED fluorescence ensures unparalleled convenience eliminating warm-up/cool-down times and all the inconveniences related lamp replacement and adjustment. Transmitted light through the exclusive **X-LED[®]** to ensure great-looking, rich and high-quality specimen view.



A new milestone achieved in Fluorescence Microscopy

- » Full-modular Fluorescence System
- » Interchangeable LED-Filtersets
- » 4 LED-Filtersets slots
- » 10% higher light intensity than HBO
- » 35% higher light intensity than Metal-Halide
- » Adjustable light intensity
- » The selection of filtersets automatically involves the switching on of the corresponding LEDs
- » Recommended for research applications
- » Cost-effective, money saving technology
- » Ready for immediate operation
- » Eliminate warm-up/cool-down times
- » Forget lamp replacement & centering

LED Fluorescence Cubes available (LED + Filterset)

Name	LED emission (nm)	Excitation filter (nm)	Dichroic mirror cut-off (nm)	Emission filter (nm)
M-1230 - Blue	460	455 - 495	500	510LP
M-1230.1 - Blue (pass band)	460	455 - 495	500	518-542
M-1231 - Green	523	510 - 550	570	575LP
M-1231.1 - Green (pass band)	523	510 - 550	570	585-625
M-1232 - Violet	405	390 - 420	440	450LP
M-1233 - UV	365	325 - 375	415	435LP
M-1233.1 - UV (pass band)	365	340 - 390	405	420-470
M-1234 - Red 1 *	623	590 - 650	660	665LP
M-1235 - Red 2 *	623	595 - 645	655	665 - 715
M-1236 - Deep Red *	660	623 - 678	685	690 - 750
M-1237 - Far Red *	740	720 - 760	770	780LP
M-1238 - Amber	590	582 - 603	610	615 - 645

* If the use of a camera is needed, when used for red emission fluorescence wavelengths above 650nm, please order OPTIKA camera code C-P6AR.

Part	Description
Observation mode:	Brightfield, LED fluorescence.
Epi-illumination and filter:	High -Power LED with brightness control. 4-position filter holder; none included.
Head:	Trinocular (2-position 100/0, 50/50), 45° inclined.
Interpupillary distance:	Adjustable between 50 and 75 mm.
Diopter adjustment:	On the left eyepiece tube.
Eyepieces:	WF10x/22 mm, high eye-point and with rubber cups.
Nosepiece:	Quintuple revolving nosepiece, rotation on ball bearings.
Objectives:	IOS LWD U-PLAN F 10x/0.30 IOS LWD U-PLAN F 20x/0.45 IOS LWD U-PLAN F 40x/0.65 All with anti-fungus treatment.

Part	Description
Specimen stage:	Mechanical stage, 250x290 mm, with round glass and metal stage, inserts for slides and 54mm dia. Petri dishes.
Focusing:	Coaxial coarse (adjustable tension) and fine focusing mechanism.
Condenser:	LWD pre-centered condenser, N.A. 0.30, W.D. 72 mm. Supplied with blue (LBD) filter.
Transmitted illumination:	X-LED [®] with white 8 W LED (6,300K) with brightness control. With aperture diaphragm. Multi-plug 100-240Vac/12Vdc external power supply.

IM-300LD4D - LED Fluorescence Microscope

2

Laboratory

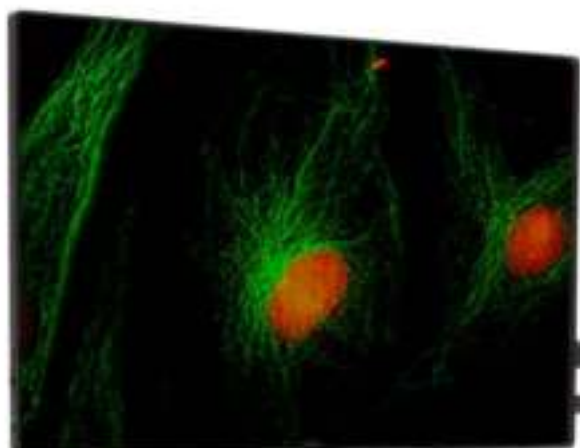

Advanced fluorescence inverted microscope for transmitted brightfield and fluorescence observations with IOS LWD U-PLAN F objectives. The extremely powerful LED Fluorescence Illuminators are combined with corresponding excitation filter sets for the visualization of most fluorochromes. LED fluorescence ensures unparalleled convenience eliminating warm-up/cool-down times and all the inconveniences related lamp replacement and adjustment. Transmitted light through the exclusive **X-LED[®]** to ensure great-looking, rich and high-quality specimen view. This model is equipped with an Intel micro PC, a 15.6" 4K touch screen, 6Mpx high-sensitivity color camera and Optika ProView image analysis software for fluorescence.

A new milestone achieved in Fluorescence Microscopy

- » Full-modular Fluorescence System
- » Interchangeable LED-Filtersets
- » 4 LED-Filtersets slots
- » 10% higher light intensity than HBO
- » 35% higher light intensity than Metal-Halide
- » Adjustable light intensity
- » The selection of filtersets automatically involves the switching on of the corresponding LEDs
- » Recommended for research applications
- » Cost-effective, money saving technology
- » Ready for immediate operation
- » Eliminate warm-up/cool-down times
- » Forget lamp replacement & centering

Name	LED emission (nm)	Excitation filter (nm)	Dichroic mirror cut-off (nm)	Emission filter (nm)
M-1230 - Blue	460	455 - 495	500	510LP
M-1230.1 - Blue (pass band)	460	455 - 495	500	518-542
M-1231 - Green	523	510 - 550	570	575LP
M-1231.1 - Green (pass band)	523	510 - 550	570	585-625
M-1232 - Violet	405	390 - 420	440	450LP
M-1233 - UV	365	325 - 375	415	435LP
M-1233.1 - UV (pass band)	365	340 - 390	405	420-470
M-1234 - Red 1	623	590 - 650	660	665LP
M-1235 - Red 2	623	595 - 645	655	665 - 715
M-1236 - Deep Red	660	623 - 678	685	690 - 750
M-1237 - Far Red	740	720 - 760	770	780LP
M-1238 - Amber	590	582 - 603	610	615 - 645

Part	Description
Observation mode:	Brightfield, LED fluorescence.
Epi-illumination and filter:	High -Power LED with brightness control. 4-position filter holder; none included.
Head:	Trinocular (2-position 100/0, 50/50), 45° inclined.
Interpupillary distance:	Adjustable between 50 and 75 mm.
Diopter adjustment:	On the left eyepiece tube.
Eyepieces:	WF10x/22 mm, high eye-point and with rubber cups.
Nosepiece:	Quintuple revolving nosepiece, rotation on ball bearings.
Objectives:	IOS LWD U-PLAN F 10x/0.30 IOS LWD U-PLAN F 20x/0.45 IOS LWD U-PLAN F 40x/0.65 All with anti-fungus treatment.

Part	Description
Specimen stage:	Mechanical stage, 250x290 mm, with round glass and metal stage inserts for slides and 54mm dia. Petri dishes.
Focusing:	Coaxial coarse (adjustable tension) and fine focusing mechanism.
Condenser:	LWD pre-centered condenser, N.A. 0.30, W.D. 72 mm. Supplied with blue (LBD) filter.
Transmitted illumination:	X-LED [®] with white 8 W LED (6,300K) with brightness control. With aperture diaphragm. Multi-plug 100-240Vac/12Vdc external power supply.
Digital equipment:	Intel micro PC with Image analysis software for Fluorescence. 15.6" 4K touch screen; 6MP IR sensitive high-sensitivity color camera.

IM-5FLD - LED Fluorescence Microscope

Phase contrast, brightfield and darkfield (dry) LED fluorescence trinocular inverted microscope, with freely configurable lenses according to customer's preferences, FN 24 high eyepoint, infinity corrected optical system, coaxial focusing, mechanical stage, Abbe condenser and powerful, uniform, white color temperature 8 W **X-LED8**. The 4-position epi-fluorescence attachment is powered by extremely powerful 5 W LEDs fluorescence illuminator and combined with blue, green and UV excitation filters for the visualization of the following fluorochromes: Acridine Yellow, Acridine Orange, Auramine, DiO, DTAF, FITC, GFP, YFP (blue filter) plus Rhodamine, Texas Red and TRITC (green filter) plus Alexa Fluor® 350, 7- Amino-4-methylcoumarin, 6-Aminoquinoline, Calcofluor® White, Dansyl cadaverine, DAPI, Dapoxyl, DIDS, Europium (III) Chloride, Fluoro-Gold™, Fura-2, Hoechst 33342 & 33258, 1,5 IAEDANS, Indo-1, Marina Blue®, 4-Methylumbelliferone, PBF1, Pyrene, SBF1, Y66F, Y66H (UV filter) among the others. LED fluorescence ensures unparalleled convenience eliminating warm-up/cool-down times and all the inconveniences related lamp replacement and adjustment. Sturdy and incredibly reliable, it is equipped with all the main controls in ergonomic position and with long lasting, efficient LED illumination to provide over 20 years of use.



IM-5FLD - Specifications



Part	Description
Head:	Trinocular (split ratio: 100/0, 0/100), 45° inclined.
Interpupillary distance:	Adjustable between 50 and 75 mm.
Dioptric adjustment:	Both eyepieces.
Eyepieces:	WF10x/24 mm, high eyepoint and with retractable rubber cups.
Epi-fluorescence illumination & filters:	High-power 5 W LEDs with brightness control, motorized LED selection with centrable field diaphragm, 4-position filter holder; blue (EX 450-490, DM 495, EM 500-550), green (EX 540-580, DM 585, EM 608-682) and UV (EX 340-390, DM 400, EM 420LP) excitation filters included.
Nosepiece:	Quintuple ball bearings revolving nosepiece, reversed.
Objectives:	Selectable according to customer's preferences. All with anti-fungus treatment.
Specimen stage:	Fixed stage, 215x250 mm and attachable mechanical stage, 290x250 mm, 120x80 mm X-Y movement range.
Focusing:	Coaxial coarse and fine focusing mechanism with limit stop to prevent the contact between objective and specimen. Adjustable tension of coarse focusing knob.
Condenser:	Abbe N.A. 0.50, removable, with iris diaphragm and slider for phase contrast.
Transmitted illumination (Full Koehler):	X-LED® with white 8 W LED and brightness control. Color temperature: 6,300 K. Multi-plug 100-240Vac/12Vdc external power supply.

Fluorescence filtersets

Name	Excitation filter (nm)	Dichroic mirror cut-off (nm)	Emission filter (nm)
B (Blue)	450 – 490	495	500 - 550
G (Green)	540 – 580	585	607 - 682
UV (Ultraviolet)	340 -390	400	420LP

IM-5FLD is freely configurable in terms of objectives, by choosing among:

Included Optional

Infinity-corrected Plan-Achromatic, Long Working Distance objectives, field flatness up to F.N. 22:		
M-782	IOS LWD W-PLAN objective 4x/0.13	<input type="checkbox"/>
M-773	IOS LWD W-PLAN objective 40x/0.60	<input type="checkbox"/>
M-786	IOS LWD W-PLAN objective 60x/0.70	<input type="checkbox"/>

Infinity-corrected Semi-Apochromatic, Long Working Distance objectives, field flatness up to F.N. 25:		
M-800	IOS LWD U-PLAN F objective 4x/0.13	<input type="checkbox"/>
M-801	IOS LWD U-PLAN F objective 10x/0.30	<input type="checkbox"/>
M-802	IOS LWD U-PLAN F objective 20x/0.45	<input type="checkbox"/>
M-803	IOS LWD U-PLAN F objective 40x/0.65	<input type="checkbox"/>
M-804	IOS LWD U-PLAN F objective 60x/0.75	<input type="checkbox"/>

Positive Phase Contrast Infinity-corrected Plan-Achromatic, Long Working Distance objectives, field flatness up to F.N. 22:		
M-782.1	IOS LWD W-PLAN PH objective 4x/0.13	<input type="checkbox"/>
M-783N	IOS LWD W-PLAN PH objective 10x/0.25	<input type="checkbox"/>
M-784N	IOS LWD W-PLAN PH objective 20x/0.40	<input type="checkbox"/>
M-785	IOS LWD W-PLAN PH objective 40x/0.65	<input type="checkbox"/>

Positive Phase Contrast Infinity-corrected Semi-Apochromatic, Long Working Distance objectives, field flatness up to F.N. 25:		
M-1177	IOS LWD U-PLAN F PH objective 20x/0.45	<input type="checkbox"/>
M-1178	IOS LWD U-PLAN F PH objective 40x/0.65	<input type="checkbox"/>

v 7.5 - OPTIKA reserves the right to make corrections, modifications, enhancements, improvements and other changes to its products at any time without notice.

Headquarters and Manufacturing Facilities

OPTIKA® S.r.l. Via Rigla, 30 - 24010 Ponteranica (BG) - ITALY - Tel.: +39 035.571.392 - info@optikamicroscopes.com

Optika Sales branches

OPTIKA® Spain spain@optikamicroscopes.com

OPTIKA® China china@optikamicroscopes.com

OPTIKA® India india@optikamicroscopes.com

OPTIKA® North America namerica@optikamicroscopes.com

OPTIKA® Central America camerica@optikamicroscopes.com

OPTIKA® Africa africa@optikamicroscopes.com

SZR-180



Research Stereomicroscope

SZR-180- Features



18:1 Zoom Ratio

The SZR-180 with its 18:1 zoom ratio puts it at the top of its class. The wide range of magnifications available (7.5x-135x), coupled with a precise click-stop mechanism for working with reproducible zoom settings, makes it ideal for both low-magnification observation and high-magnification screening and observation of small cell structures.

PLAN APO 1x objective

The Plan APO 1x apochromatic main objective provides high-resolution images at both low and high magnifications, making it ideal for observing and capturing images of the smallest details free of aberrations and halos.

Combined with the zoom and the generous 23mm field number eyepieces, this provides a large FOV even at high magnifications (1.7mm).



Ergonomic stand with diasopic LED lighting

Ergonomically designed, the SZR-180's wide base offers a huge space for sample holders, intuitive controls and an extremely low profile for easy access and reduced fatigue-free body movement. The LED diasopic illumination is designed to achieve high overall contrast and includes the innovative OIC (Oblique Illumination Contrast) system, ideal for transparent structures, and dark-field illumination.

SZR-180- Specifications

The SZR-180 is the top-of-the-range stereo zoom microscope dedicated to the world of research. With a wide magnification range and high optical resolution combined with effective ergonomics, the SZR-180 is the perfect companion in advanced research. The 18:1 zoom allows you to observe a wide range of samples, from single cells to entire microorganisms.

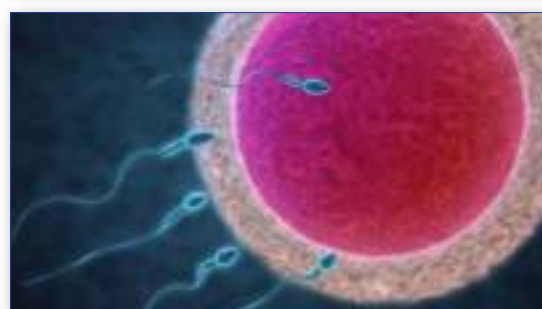

Part	Description
Head:	Trinocular 100/0 - 0/100 (on right tube), 20° inclined.
Interpupillary distance:	52-112 mm.
Dioptric adjustment:	Both eyepieces.
Eyepieces:	WF10x/23 mm, high eyepoint with rubber cups.
Objective:	PLAN Achromatic 1x, N.A. 0.15, 7.5x-135x (zoom ratio 18:1), zoom click stops at 0.75x, 1x, 2x, 3x, 6x, 10x, 13.5x with aperture diaphragm.
Working distance:	60 mm.
Stand:	High-grade, precision fixed with handle and focus.
Focusing:	Coaxial coarse & fine, coarse total travel 125 mm, fine single rotation 2 mm. Rack and pinion focusing mechanism.
Stage:	Glass transparent plate for transmitted illumination diameter 180 mm.
Illumination:	LED transmitted, with OIC (Oblique Illumination Contrast) and darkfield illumination. Multi-plug 100-240Vac/12Vdc external power supply.

SZR-180 - Optical Performance

Eyepiece	10x	
Field number (mm)	23	
Objective	Total magnification	Field of View (mm)
1x (W.D: 60 mm)	7.5x-135x	30.60 - 1.70



SZR-180 - Accessories

Miscellaneous

- 15104 Cleaning kit
- DC-004 TNT dust cover, extra large, 700(l)x550(h) mm
- M-005 Micrometric slide, 26x76mm, with 2 scales (1mm/100 & 10mm/100)
- AB-030 Antibacterial surface treatment, only for newly purchased microscope

15104 - Cleaning kit

It cleans glass quickly and effectively, without leaving residue or odor. Ideal for precision lens or prism cleaning.



How to connect the cameras to our microscopes.
Please refer to the Adapter reference list on Digital section.

v 7.5 - OPTIKA reserves the right to make corrections, modifications, enhancements, improvements and other changes to its products at any time without notice.

Headquarters and Manufacturing Facilities

OPTIKA® S.r.l. Via Rigla, 30 - 24010 Ponteranica (BG) - ITALY - Tel.: +39 035.571.392 - info@optikamicroscopes.com

Optika Sales branches

OPTIKA® Spain spain@optikamicroscopes.com
OPTIKA® China china@optikamicroscopes.com
OPTIKA® India india@optikamicroscopes.com

OPTIKA® North America namerica@optikamicroscopes.com
OPTIKA® Central America camerica@optikamicroscopes.com
OPTIKA® Africa africa@optikamicroscopes.com

OPTIKA[®]
M I C R O S C O P E S
I T A L Y



INSPECTION & INDUSTRIAL Microscopes

INSPECTION & INDUSTRIAL Microscopes

Professional Stereo Microscopes

SLX SERIES - Stereomicroscopes For Higher Education & Laboratory page 281

SZ SERIES - Stereozoom Microscopes For Laboratory & Industry page 291

SZP SERIES - Advanced CMO Stereozoom Microscopes page 307

CL SERIES - Cold Light Illuminators page 315



























GEM SERIES - Stereozoom Microscopes For Gemology page 319

Industrial Microscopes

MET SERIES - Metallurgical Microscopes page 329

IS SERIES - Inspection Video Microscopes page 343

Icons

	Field number		W-Plan objectives (up to 22mm f.o.v)		Tablet screen size
	Incident light		U-Plan objectives (up to 24mm f.o.v)		Camera resolution
	Transmitted light		Oil/Water 100x objective		Software included
	LED illuminator		Fluorescence		HDMI output
	X-LED illuminator		Metallography		MicroSD slot
	Automatic light control		Polarized light		Wi-Fi
	Multi-Plug low voltage power supply		Darkfield		BlueTooth
	Infinity corrected optics		Phase contrast		IVD Available *
	N-Plan objectives (up to 20mm f.o.v)		USB connection		Antibacteria treatment available

OPTIKA[®]
M I C R O S C O P E S
I T A L Y

SLX Series



Stereomicroscopes For Higher Education & Laboratory

Extremely Versatile Cordless Stereo & Stereozoom Microscopes

PROFESSIONAL FEATURES FOR... WELL, EVERYONE

- » Level up skills and become a professional user
- » 3D Greenough view for high resolved images & large field depth
- » 6.43:1 ratio - 7x ... 45x - or turnable objective - 2x, 4x - on 21 mm
- » Compact, practical and intuitive to use
- » Sturdy and durable for extended lifetime

THE LONGEST AUTONOMY ON THE MARKET

- » Longlife LED illumination (providing over 20 years of use)
- » Ultra-flat base with Ø 100 mm disc for diffused transmitted light
- » Cordless use, totally independent from mains/batteries connection
- » Freely settable illumination - incident, oblique and transmitted light
- » External power supply for enhanced safety and convenient servicing

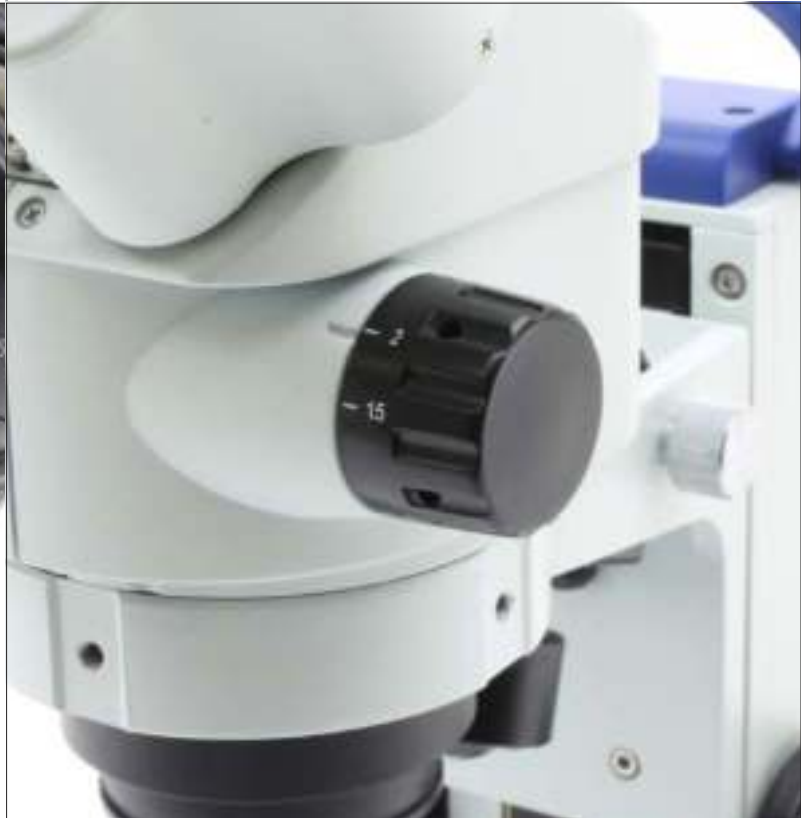

SLX Series

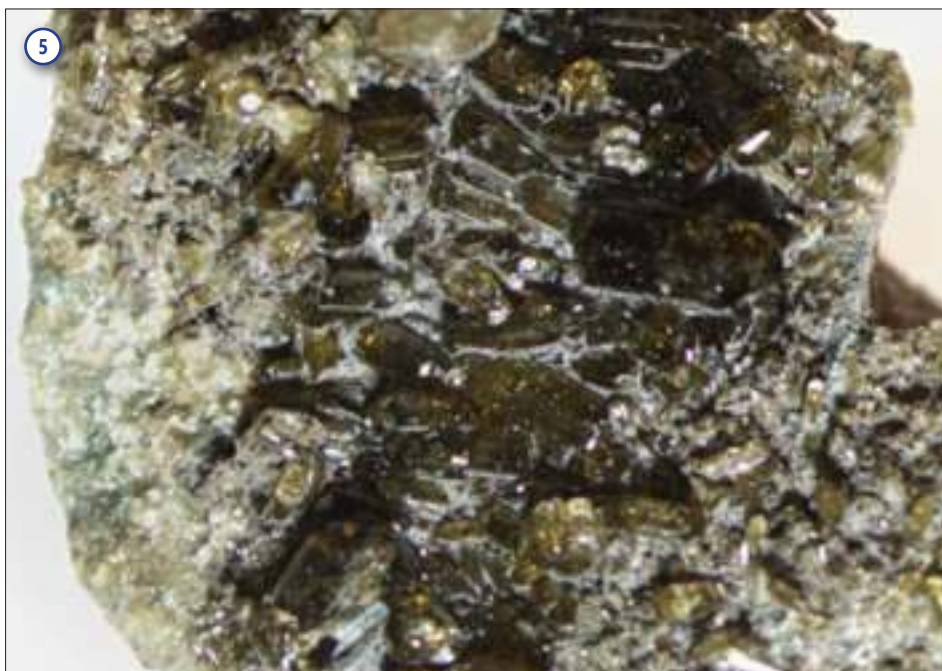
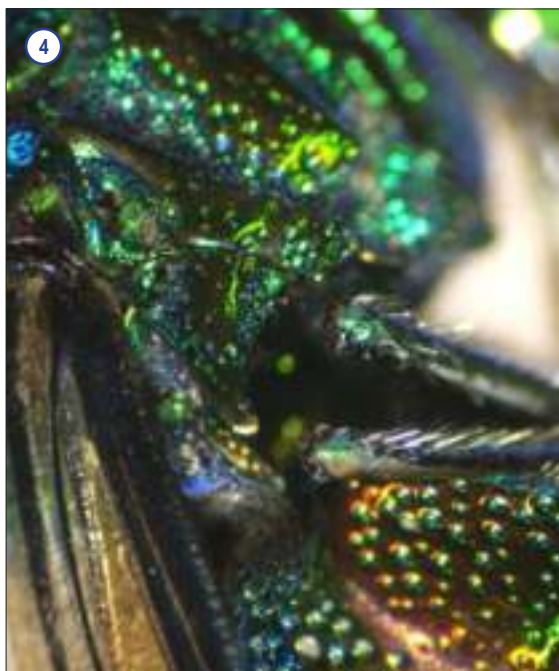

Legend

- | | |
|---|---------------------------------------|
| 1. Aluminum - SLX-1 and 4x objective. | 4. Fly, detail - SLX-2 and 4.5x zoom. |
| 2. Component worked on lathe - SLX-2 and 3x zoom. | 5. Rock - SLX-2 - 1.5x zoom. |
| 3. Wasp - SLX-3 and 4x zoom. | |

SLX Series



Valuable configurations of cordless and modern stereo & stereozoom microscopes ideal for a variety of applications, including dissection, biology, entomology, anatomy, chemistry, material science among the others and even industrial purposes.

Provided with dual magnification or **6.43:1 zoom ratio**, **FN 21** high eyepoint eyepieces, high-grade precise fixed arm with focus and handle with the latest technology of **EcoLED™** illumination plus rechargeable batteries. Slim and easy to carry, all the models with high-grade precise fixed arm are equipped with long lasting **LED** illumination to provide over 20 years of use.

High eyepoint eyepieces for glasses wearers

These eyepieces are designed in such a way that the exit pupil is further away from the eye lens than standard eyepieces, being well suited for eyeglasses wearers

The longest autonomy on the market ensured by EcoLED™

OPTIKA has re-designed illumination in microscopy, once again: a special coating process on optics combined with a new, higher ratio between low consumptions and ultra-efficiency has addressed us to top brightness levels

6.43:1 zoom ratio - zoom magnification from 7x to 45x

Purposely designed for professional routine inspections, the total magnification can be even extended to 135x with 20x eyepieces and 1.5x additional lens, obtaining an excellent results in this class



Ultra-flat base with Ø 100 mm disc for diffused transmitted light

A new level of ergonomics and comfort is achieved during operations, with the ultra-flat base of only 3 cm height to ensure smooth specimen movement and the Ø 100 mm for top class diffusion of the transmitted light

Stereomicroscopes For Higher Education & Laboratory



Longlife LED illumination (providing over 20 years of use)

Money & energy saving thanks to LED long lifetime (65.000 hours, 22 years in case of 8 hours/day) which is more than 20 times compared to a standard halogen bulb.

Cordless use, totally independent from mains/batteries connection

All models work with or without the batteries in place with three NiMH rechargeable batteries (not included) for the longest autonomy in outdoor use (12-hour autonomy, at medium intensity).



External power supply for enhanced safety and convenient servicing

OPTIKA's safety first approach drives to the use of a low voltage, multi-plug, external power supply in order to prevent any risk of electric shock and heatflow inside the unit.

SLX Series - Get the most out of our accessories

Additional Lenses

Simply to be screwed into the threads below the objectives of SLX-2 and SLX-3 to either increase or decrease total magnification, or to increase the working distance when users need to work with hands under the microscope



ST-091 - Additional lens 0.75x

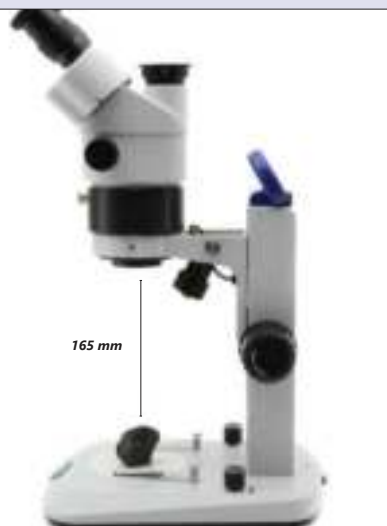

ST-085.1 - Additional lens 0.5x (w.d. 165mm) with SZ-EXT

ST-040.1 - Darkfield condenser

This is a darkfield condenser for stereo microscopes with bottom light and 100 mm round working plate to provide dark-field microscopy features, fitting all OPTIKA stereomicroscopes with 100 mm mounting size and transmitted light



ST-040.1 - Darkfield condenser, 100mm diameter

SLX Series - Range

SLX-1



Cordless binocular stereomicroscope ideal for students, schools and amateurs to dissect and discover mainly biology and materials science in 3D, with turnable objective (2x-4x), FN 21 high eyepoint, precision fixed arm with handle and the latest technology of EcoLED™ illumination plus rechargeable batteries (not included). Slim and easy to carry, it is equipped with long lasting LED illumination to provide over 20 years of use.

Head: Binocular, 45° inclined; 360° rotating.

Dioptric adjustment: Left eyepiece.

Eyepieces: WF10x/21 mm, high eyepoint, secured by screw and with rubber cups.

Objective: Achromatic 2x-4x with anti-fungus treatment.

Working distance: 100 mm.

Stand: High-grade, precision fixed with handle and focus.

Focusing: Rack and pinion focusing mechanism.

Illumination: EcoLED™ swiveling incident and transmitted, with brightness control, rechargeable batteries (not included). Color temperature: 6,300 K. Multi-plug 100-240Vac/5Vdc external power supply.

SLX-2



Cordless binocular stereozoom microscope ideal for students, schools and amateurs to dissect and discover mainly biology and materials science in 3D, with 0.7x...4.5x zoom, FN 21 high eyepoint, precision fixed arm with handle and the latest technology of EcoLED™ illumination plus rechargeable batteries (not included). Slim and easy to carry, it is equipped with long lasting LED illumination to provide over 20 years of use.

Head: Binocular, 45° inclined; 360° rotating.

Dioptric adjustment: Both eyepieces.

Eyepieces: WF10x/21 mm, high eyepoint, secured by screw and with rubber cups.

Objective: Parfocal achromatic zoom 0.7x...4.5x (6.43:1 ratio) with anti-fungus treatment.

Working distance: 100 mm.

Stand: High-grade, precision fixed with handle and focus.

Focusing: Rack and pinion focusing mechanism.

Illumination: EcoLED™ swiveling incident and transmitted, with brightness control, rechargeable batteries (not included). Color temperature: 6,300 K. Multi-plug 100-240Vac/5Vdc external power supply.

SLX Series - Range

SLX-3



Cordless trinocular stereozoom microscope ideal for students, schools and amateurs to dissect and discover mainly biology and materials science in 3D, with 0.7x...4.5x zoom, FN 21 high eyepoint, precision fixed arm with handle and the latest technology of EcoLED™ illumination plus rechargeable batteries (not included). Slim and easy to carry, it is equipped with long lasting LED illumination to provide over 20 years of use.

Head: Trinocular (split ratio: 50/50), 45° inclined; 360° rotating.

Dioptric adjustment: Both eyepieces.

Eyepieces: WF10x/21 mm, high eyepoint, secured by screw and with rubber cups.

Objective: Parfocal achromatic zoom 0.7x...4.5x (6.43:1 ratio) with anti-fungus treatment.

Working distance: 100 mm

Stand: High-grade, precision fixed with handle and focus.

Focusing: Rack and pinion focusing mechanism.

Illumination: EcoLED™ swiveling incident and transmitted, with brightness control, rechargeable batteries (not included). Color temperature: 6,300 K. Multi-plug 100-240Vac/5Vdc external power supply.



SLX Series - Range

SLX-4 / SLX-5

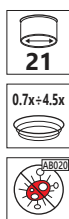

SLX-5

Binocular (SLX-4) or trinocular (SLX-5) stereomicroscope with Extremely stable, long overhanging stand for observation of particularly large specimens to be matched with a focusing system and stereozoom head. Smooth horizontal and vertical movements are ensured and the head can be easily swivelled for inspection at oblique angles. In case illumination is needed, choose from the wide choice of external illuminators available.

Head:

SLX-4: Binocular, 45° inclined; 360° rotating.

SLX-5: Trinocular (split ratio: 50/50), 45° inclined; 360° rotating.

Dioptric adjustment: Both eyepieces.

Eyepieces: WF10x/21 mm, high eyepoint, secured by screw and with rubber cups.

Objective: Parfocal achromatic zoom 0.7x...4.5x (6.43:1 ratio) with anti-fungus treatment.

Working distance: 100 mm.

Focusing: Rack and pinion mechanism controlled by a pair of knobs placed on both sides of the stand.

Stand: Overhanging stand 420 mm high, 430 mm horizontal arm length, base 230x230 mm with following adjustments: height, longitudinal extension and head rotation angle (left-right).

SLX Series - Comparison Chart

Model	Head	Eyepieces	Objective	Working Distance	Stand	Illumination
SLX-1	Binocular 45° inclined 360° rotating	WF 10x/21	2x – 4x selectable	100 mm	High-grade, precision fixed with handle and focus	EcoLED™ swiveling incident and transmitted with brightness control, rechargeable batteries (not included)
SLX-2	Binocular 45° inclined 360° rotating	WF 10x/21	0.7x...4.5x zoom	100 mm	High-grade, precision fixed with handle and focus	EcoLED™ swiveling incident and transmitted with brightness control, rechargeable batteries (not included)
SLX-3	Trinocular (50/50) 45° inclined 360° rotating	WF 10x/21	0.7x...4.5x zoom	100 mm	High-grade, precision fixed with handle and focus	EcoLED™ swiveling incident and transmitted with brightness control, rechargeable batteries (not included)
SLX-4	Binocular 45° inclined 360° rotating	WF 10x/21	0.7x...4.5x zoom	100 mm	Overhanging stand	Without illumination; External light source needed
SLX-5	Trinocular (50/50) 45° inclined 360° rotating	WF 10x/21	0.7x...4.5x zoom	100 mm	Overhanging stand	Without illumination; External light source needed

Optical performance SLX-1

Eyepiece	10x (ST-081)		15x (ST-082)		20x (ST-083)		10x (ST-084)	
Field number (mm)	21		15		10		21	
Additional lens	Total magnification	Field of View (mm)	Total magnification	Field of View (mm)	Total magnification	Field of View (mm)	Total magnification	Field of View (mm)
1x	20x - 40x	10.50 - 5.25	30x - 60x	7.50 - 3.75	40x - 80x	5.00 - 2.50	20x - 40x	10.50 - 5.25

Optical performance SLX-2 - SLX-3 - SLX-4 - SLX-5

Eyepiece	10x (ST-081)		15x (ST-082)		20x (ST-083)		10x (ST-084)	
Field number (mm)	21		15		10		21	
Additional lens	Total magnification	Field of View (mm)	Total magnification	Field of View (mm)	Total magnification	Field of View (mm)	Total magnification	Field of View (mm)
0.5x	3.5x - 22.5x	60.00 - 9.33	5.25x - 33.75x	42.86 - 6.67	7x - 45x	28.57 - 4.44	3.5x - 22.5x	60.00 - 9.33
0.75x	5.25x - 33.75x	40.00 - 6.22	7.875x - 50.625x	28.57 - 4.44	10.5x - 67.5x	19.05 - 2.96	5.25x - 33.75x	40.00 - 6.22
1x	7x - 45x	30.00 - 4.67	10.5x - 67.5x	21.43 - 3.33	14x - 90x	14.29 - 2.22	7x - 45x	30.00 - 4.67
1.5x	10.5x - 67.5x	20.00 - 3.11	15.75x - 101.25x	14.29 - 2.22	21x - 135x	9.52 - 1.48	10.5x - 67.5x	20.00 - 3.11



3 SLX Series - Accessories

Eyecups & Eyepieces

- ST-036 Eyecups (pair), flat
- ST-081 EW10x/21 eyepieces (pair), high eyepoint, with rubber cup
- ST-082 WF15x/15 eyepieces (pair), high eyepoint
- ST-083 WF20x/10 eyepieces (pair), high eyepoint
- ST-084 WF10x/21 micrometric eyepiece, high eyepoint, with rubber cup

Additional Lenses

- ST-085.1 Additional lens 0.5x (w.d. 165mm) with SZ-EXT (except for SLX-1)
- ST-091 Additional lens 0.75x (w.d. 105mm) (except for SLX-1)
- ST-086.1 Additional lens 1.5x (w.d. 45mm) with compensating disc (except for SLX-1)
- ST-087 Additional lens 2x (w.d. 33mm) (only for SLX-4 & SLX-5)

Stages

- ST-100.1 Hand moving stage, 100mm diameter
- ST-110.1 Moving stage, coaxial knobs, 100mm diameter
- ST-111.1 Moving stage, micrometric screws, 100mm diameter

Condensers & Filters

- ST-040.1 Darkfield condenser, 100mm diameter
- ST-088.1 Polarising set (filters and rotating stage), 100mm diameter

Camera Adapters

- M-113.1 Ring adapter, 30mm (for monocular and binocular microscopes)
- M-115 0.35x C-Mount projection lens
- M-114 0.5x C-Mount projection lens
- M-118 0.75x C-Mount projection lens
- M-173 C-Mount projection lens for APS-C/full frame reflex cameras (trino)
- M-699 Universal adapter for C-Mount projection lens (trino)
- M-620 0.35x focusable C-Mount adapter
- M-620.1 0.5x focusable C-Mount adapter
- M-620.2 0.65x focusable C-Mount adapter
- M-620.3 1x focusable C-Mount adapter

Miscellaneous

- 15104 Cleaning kit
- DC-002 Plastic dust cover, medium, 490(l)x490(h) mm (only for SLX-1, SLX-2 and SLX-3)
- DC-004 TNT dust cover, large, 700(l)x550(h) mm (only for SLX-4 & SLX-5)
- M-005 Micrometric slide, 26x76mm, with 2 scales (1mm/100 & 10mm/100)
- ST-041 Sample clip
- ST-042 White/black object-plate, 100mm diameter
- ST-043 Glass object-plate, 100mm diameter
- ST-092 Protective glass for stereohead
- VP-SLX IQ/OQ/PQ manual for SLX series
- AB-020 Antibacterial surface treatment, only for newly purchased microscope



How to connect the cameras to our microscopes.

Please refer to the Adapter reference list on Digital section.

15104 - Cleaning kit

It cleans glass quickly and effectively, without leaving residue or odor. Ideal for precision lens or prism cleaning.



v 7.5 - OPTIKA reserves the right to make corrections, modifications, enhancements, improvements and other changes to its products at any time without notice.

Headquarters and Manufacturing Facilities

OPTIKA® S.r.l. Via Rigla, 30 - 24010 Ponteranica (BG) - ITALY - Tel.: +39 035.571.392 - info@optikamicroscopes.com

Optika Sales branches

OPTIKA® Spain spain@optikamicroscopes.com
OPTIKA® China china@optikamicroscopes.com
OPTIKA® India india@optikamicroscopes.com

OPTIKA® North America namerica@optikamicroscopes.com
OPTIKA® Central America camerica@optikamicroscopes.com
OPTIKA® Africa africa@optikamicroscopes.com

OPTIKA[®]
M I C R O S C O P E S
I T A L Y

SZ Series



Stereozoom Microscopes For Laboratory & Industry

FIELD OF VIEW - 23 mm Full Plan Field of View

10x/22mm or 10x/23mm PLAN EYEPIECES

Plan eyepieces with 22 or 23 mm field of view; high eye-point type, also suitable for the use of eyeglasses.

ZOOM OBJECTIVE

The High-Grade Zoom Objective ensures a sharp and clear vision. With a zoom ratio of 6.72:1 or 8.46:1 it makes this series a perfect instrument for any application.



CLICK-STOP DETENTS

On SZO Heads the zoom objective is equipped with a precise click-stop mechanism which makes easy to quickly find the default zoom positions: 0.67x, 0.80x, 1x, 1.2x, 1.5x, 2x, 2.5x, 3x, 3.5x, 4x, and 4.5x.



X-LED - Two Times Brighter Than Any Other

X-LED: A SEA OF LIGHT

Where present, stands' illuminators are equipped with X-LED systems:

- the incident illuminator with **X-LED³** (single LED, 3.6W)
- the transmitted illuminator with **X-LED^{T1-T3}** (12 or 60 LEDs)

X-LED: RESPECTING COLORS

With 6,300K color temperature the specimens are illuminated with the most natural light. It allows to respect their colors, without altering the nuances.



X-LED^{T3}: SIMPLY UNMATCHABLE

Top class illuminator for transmitted light. With up to 60 LEDs geometrically arranged, it grants a perfect light uniformity and the observation of large samples thanks to its 10cm diameter.



Multi-plug power supply

SZ Series

Greenough Optical System

The V-shape optical path of Greenough allows us to design a very compact and a slim unit, highly versatile and appreciated for the 3D viewing. Samples with significant depth can be quickly inspected. Binocular and trinocular heads are 45° inclined to ensure comfortable posture to the user even after several hours of operation.

Zoom Ratio

SZ Series has 0.67x-4.5x or 0.65x-5.5x zoom range (6.72:1 or 8.46:1 zoom ratio, depending on the head), being purposely designed for routine and advanced inspections. These zoom ratios enable most samples to be observed at the appropriate magnifications. When combined with proper accessories (2x additional lens and 25x eyepieces), SZX-A delivers excellent image quality up to 275x.

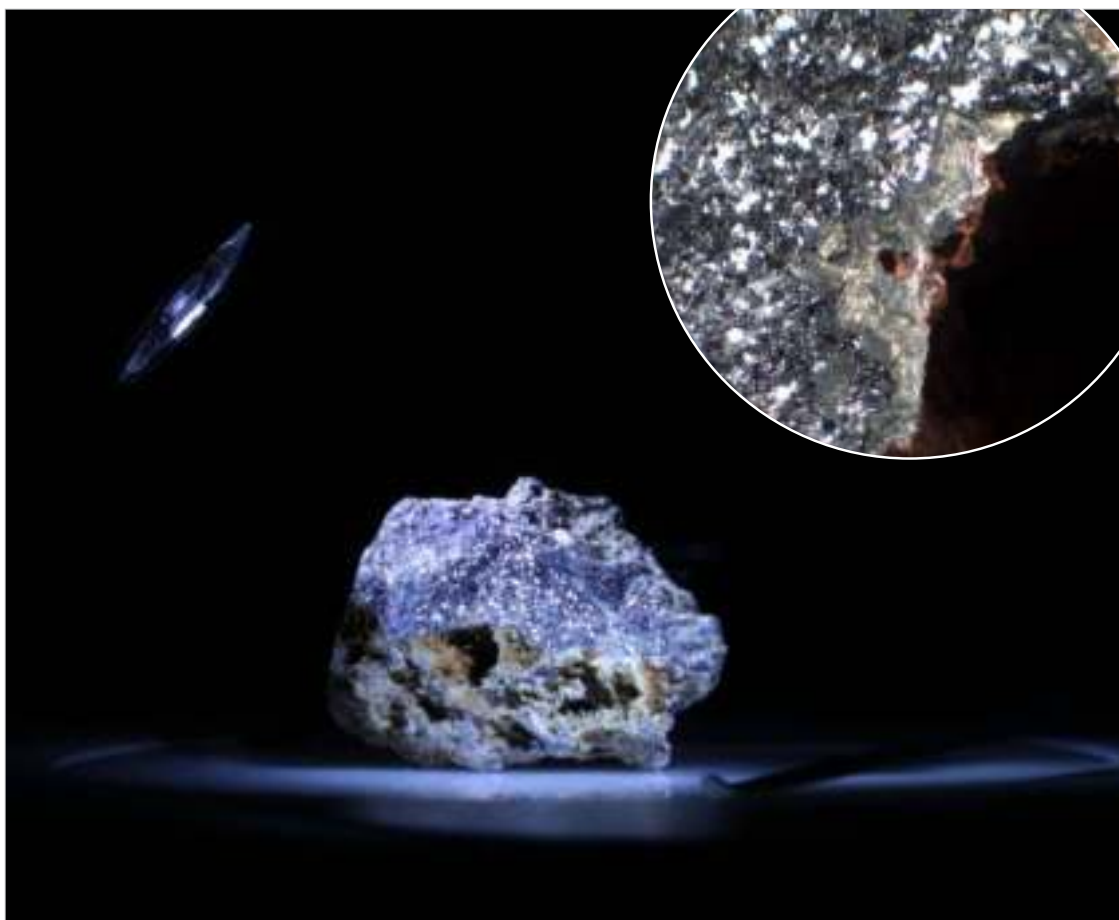

X-LED Exclusive Lighting Source

Special technology able to double the light intensity for incomparable performance, ensuring constant pure-white colour temperature.

Relevant money & energy saving thanks to the incredibly low energy consumptions allow you to cut the electricity bills by 90%!

Stereozoom Microscopes For Laboratory & Industry

Overhanging Stands, In Case Of Large Samples

These stands are recommended for efficient, quick and precise observation and digital imaging of large samples, that cannot be processed with regular stands.

Achieve 360° rotation and smooth movement with no limits, as the mechanism can be tilted from right to left, backward to forward.

Large Working Distance And Field Of View Size Are Important!

If you need to operate under the microscope, you will need a large working distance. SZ series ensures an extended working distance of 110mm. Keep in my mind your application, always: if you are soldering a printed circuit board, it may be more important to have a long working distance; if you are counting items, then a large field of view will be of great help.



Get the most out of our accessories



ST-088 - Polarizing Set

The ST-088 Polarizing Set features a pair of top quality linear polarization filters. The analyzer is mounted on a circular metallic holder equipped with a goniometric scale for determining the extinction angle characteristic of substances and materials.

SZ Series - Modular Chart

SZX-B
WF 10x/22
0.67x...4.5x



SZX-T
WF 10x/22
0.67x...4.5x



SZX-BA
WF 10X/23
0.65x...5.5x



SZ-A1
Coarse focus



SZ-A6
Coarse & Fine focus



ST-150
Flat Industrial Stand with pillar



SZ-ST1
Simple Stand



SZ-ST2
Stand with Incident (X-LED³) and Transmitted (12-Led) Illuminators



SZ-ST3
Stand with Incident (X-LED³) and Transmitted (60-Led) Illuminators



SZ-ST7
Stand with **Double Incident** (X-LED³) and Transmitted (12-Led) Illuminators



SZ-ST8
Stand with **Double Incident** (X-LED³) and Transmitted (60-Led) Illuminators



SZ-OBL
Base with **oblique illumination** (X-LED³)

SZ Series - Modular Chart

SZX-TA
WF 10X/23
0.65x - 5.5x



SZO-B
WF 10X/23
0.67x...4.5x Click-stops



SZO-T
WF 10X/23
0.67x...4.5x Click-stops



ST-152

Flat Industrial Stand
with fixed arm



SZ-STLX

Advanced Precision Overhanging Stand
with Coarse Focus Mechanism



SZ-STL5

Flexible arm stand, 360°rotating



SZ-STL1

Overhanging Stand



SZ-STL2

Advanced Overhanging Stand



SZ-STL5LED

Flexible arm stand, 360°rotating
with 2x incident (X-LED³) illuminators



SZ Series - Heads

SZX-B / SZX-T



SZX Heads - Excellent Price/Performance Ratio For Any Laboratory

- » Ideal for universities, experts & common routine lab requirements
- » 3D Greenough view for high resolved images & large field depth
- » 22 mm field number and large working distance (up 110 mm)
- » 6.72:1 zoom ratio - zoom magnification from 6.7x to 45x
- » Simultaneous eyepiece & camera observation (on SZX-T)
- » Cost-effective solution for diversified applications

Head:

SZX-B: Binocular, 360° rotating on all stands and 45° inclined.

SZX-T: Trinocular (split ratio: 50/50), 360° rotating on all stands and 45° inclined.

Interpupillary distance: Adjustable between 51 and 75 mm.

Dioptric adjustment: On both eyepieces.

Eyepieces: WF10x/22 mm, high eyepoint, secured by screw and with integrated rubber cups.

Objective: Parfocal achromatic zoom 0.67x...4.5x (zoom factor 6.72:1)

Working distance: 100 mm.

SZX-BA / SZX-TA



SZX-A Heads - Advanced Analysis With High Power Magnification

- » Purposely designed for particularly performing zoom conditions
- » 3D Greenough view for high resolved images & large field depth
- » 23 mm field number and large working distance (up 110 mm)
- » 8.46:1 zoom ratio - zoom magnification from 6.5x to 55x
- » Simultaneous eyepiece & camera observation (on SZX-TA)
- » High magnification change from overview to tiny details

Head:

SZX-BA: Binocular, 360° rotating on all stands and 45° inclined.

SZX-TA: Trinocular (split ratio: 50/50), 360° rotating on all stands and 45° inclined.

Interpupillary distance: Adjustable between 51 and 75 mm.

Dioptric adjustment: On both eyepieces.

Eyepieces: WF10x/23 mm, high eyepoint, secured by screw and with integrated rubber cups.

Objective: Parfocal achromatic zoom 0.65x...5.5x (zoom factor 8.46:1).

Working distance: 102 mm.

SZ Series - Heads

SZO-B / SZO-T



SZO Heads - Addressed For Extreme Reliability & Repeatability

- » Ensuring the sharpest vision, high productivity, repetitive analysis
- » 3D Greenough view for high resolved images & large field depth
- » 23 mm field number and large working distance (up 110 mm)
- » 6.72:1 zoom ratio - zoom magnification from 6.7x to 45x
- » Simultaneous eyepiece & camera observation (on SZO-T)
- » Multi-position click-stop - no need to move eyes from eyepieces

Head:

SZO-B: Binocular, 360° rotating on all stands and 45° inclined.

SZO-T: Trinocular (split ratio: 70/30), 360° rotating on all stands and 45° inclined.

Interpupillary distance: Adjustable between 51 and 75 mm.

Dioptric adjustment: On both eyepieces.

Eyepieces: WF10x/23 mm, high eyepoint, secured by screw and with retractable rubber cups.

Objective: Parfocal achromatic zoom 0.67x...4.5x (zoom factor 6.72:1) with click-stop.

Working distance: 110 mm.

CLICK-STOP DETENTS

On SZO Heads the zoom objective is equipped with a precise click-stop mechanism which makes easy to quickly find the default zoom positions: 0.67x, 0.80x, 1x, 1.2x, 1.5x, 2x, 2.5x, 3x, 3.5x, 4x, and 4.5x.

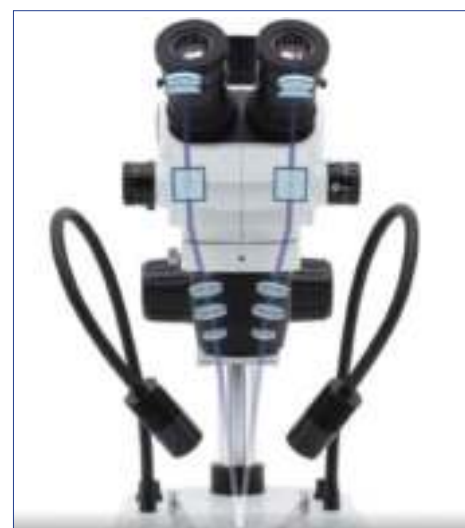

SZ Series - Zoom Heads Comparison Chart

Model	Head	Eyepieces	Zoom Objective	Zoom Ratio	Click-Stops Detents	Working Distance	Photo Tube
SZX-B	Binocular 45° inclined	WF 10x/22	0.67x...4.5x	6.72:1	-	100 mm	-
SZX-T	Trinocular 45° inclined	WF 10x/22	0.67x...4.5x	6.72:1	-	100 mm	Fixed 50%-50%
SZX-BA	Binocular 45° inclined	WF 10x/23	0.65x...5.5x	8.46:1	-	102 mm	-
SZX-TA	Trinocular 45° inclined	WF 10x/23	0.65x...5.5x	8.46:1	-	102 mm	Fixed 50%-50%
SZO-B	Binocular 45° inclined	WF 10x/23	0.67x...4.5x	6.72:1	0.67x, 0.80x, 1x, 1.2x, 1.5x, 2x, 2.5x, 3x, 3.5x, 4x, and 4.5x	110 mm	-
SZO-T	Trinocular 45° inclined	WF 10x/23	0.67x...4.5x	6.72:1	0.67x, 0.80x, 1x, 1.2x, 1.5x, 2x, 2.5x, 3x, 3.5x, 4x, and 4.5x	110 mm	Fixed 70%-30%

SZ Series - Pillar Stands

SZ-ST1



Extremely stable, ultra-slim and modern stand to be matched with a focusing system and stereozoom head. The 25 mm height makes this stand very effective in preventing fatigue during operation, increasing the ergonomics and the performance as a result. In case illumination is needed, choose from the wide choice of external illuminators available.

Width: 210 mm

Length: 270 mm

Thickness: 25 mm

Pillar diameter: 32 mm

Pillar height: 275 mm

Stage: 95 mm dia., black and white disc with sample clips

Incident illumination: None

Transmitted illumination: None

To be used in combination with a focusing mechanism (SZ-A1/A6)

SZ-ST2 / SZ-ST3



Top-class X-LED^T transmitted light, with geometrically arranged LEDs and X-LED³ incident light

The impressive incident illumination generated by the exclusive X-LED³ swivelling illuminator (3.6 W) is combined with an extra-large, settable 12-LED X-LED^T disc (2 W, on SZ-ST2) or 60-LED X-LED^{T3} disc (4 W, on SZ-ST3) for transmitted illumination.

Incident illumination: X-LED³ with white 3.6 W LED and brightness control. Color temperature: 6,300 K.

Transmitted illumination:

SZ-ST2: 12-LED X-LED^{T1} disc with white 2 W LED and brightness control. Color temperature: 6,300 K. Multi-plug 100-240Vac/6Vdc external power supply.

SZ-ST3: 60-LED X-LED^{T3} disc with white 4 W LED and brightness control. Color temperature: 6,300 K. Multi-plug 100-240Vac/12Vdc external power supply.

Base dimensions: 270×210 mm.

Pillar dimensions: Ø32×280 mm.

Weight: 1.90 kg.

To be used in combination with a focusing mechanism (SZ-A1/A6)

SZ-ST7 / SZ-ST8



Top-class X-LED^T transmitted light, with geometrically arranged LEDs and freely orientable, flexible double gooseneck X-LED³ incident light

The impressive incident illumination generated by the exclusive X-LED³ lighting system located in two flexible gooseneck arms (3.6 W each, for a total of 7.2 W) is combined with an extra-large, settable 12-LED X-LED^{T1} disc (2 W, on SZ-ST7) or 60-LED X-LED^{T3} disc (4 W, on SZ-ST8) for transmitted illumination.

Incident illumination: Two flexible X-LED³ gooseneck arms with white 3.6 W LED/each and brightness control. Illuminance: 170,000 lux (at 10 cm distance). Color temperature: 6,300 K.

Transmitted illumination:

SZ-ST7: 12-LED X-LED^{T1} disc with white 2 W LED and brightness control. Illuminance: 4,000 lux. Color temperature: 6,300 K. Multi-plug 100-240Vac/12Vdc external power supply.

SZ-ST8: 60-LED X-LED^{T3} disc with white 4 W LED and brightness control. Illuminance: 8,000 lux. Color temperature: 6,300 K. Multi-plug 100-240Vac/12Vdc external power supply.

Base dimensions: 270×210 mm.

Pillar dimensions: Ø32×280 mm.

Stage: 95 mm dia., translucent and black/white discs with sample clips

Weight: 2.40 kg.

To be used in combination with a focusing mechanism (SZ-A1/A6)

SZ Series - Pillar Stands

SZ-OBL

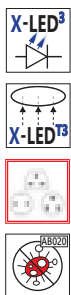

Extremely stable and modern stand, equipped with rotatable mirror and X-LED³ transmitted light. Ideal for observing low-contrast samples that cannot be stained. The X-LED³ light source with its high efficiency and no indirect heating is ideal for observing "live" specimens. Tiltable mirror with 2 faces, one smooth and one knurled, to get maximum contrast from your samples.

Transmitted illumination:

X-LED³ disc frosted white and brightness control.
 Illuminance: 8,000 lux. Color temperature: 6,300 K.
 Multi-plug 100-240Vac/6Vdc external power supply.

Base dimensions: 270x210 mm.

Pillar dimensions: Ø32x280 mm.

Weight: 2.4 kg.

To be used in combination with a focusing mechanism (SZ-A1/A6)

SZ Series - X-LED Comparison



SZ-ST2: 12-Led **X-LED⁷¹**
Transmitted Illuminator



SZ-ST3: 60-Led **X-LED⁷³**
Transmitted Illuminator



SZ-ST7: 12-Led **X-LED⁷¹**
Transmitted Illuminator



SZ-ST8: 60-Led **X-LED⁷³**
Transmitted Illuminator

SZ Series - Pillar Stands Comparison Chart

Model	Base	Pillar	Stage	Incident Illumination	Transmitted Illumination
SZ-ST1	270x210x25h mm	32dia.x275h mm	95 mm dia., black and white disc with sample clips	None	None
SZ-ST2	270x210x30h mm	32dia.x280h mm	95 mm dia., white disc with sample clips	X-LED³ (single Led, 3.6 W); brightness control	X-LED⁷¹ (12-Led); brightness control
SZ-ST3	270x210x30h mm	32dia.x280h mm	95 mm dia., white disc with sample clips	X-LED³ (single Led, 3.6 W); brightness control	X-LED⁷³ (60-Led); brightness control
SZ-ST7	270x210x30h mm	32dia.x280h mm	95 mm dia., white disc with sample clips	Double X-LED³ (total 7.2 W) on flexible goosencs; brightness control	X-LED⁷¹ (12-Led); brightness control
SZ-ST8	270x210x30h mm	32dia.x280h mm	95 mm dia., white disc with sample clips	Double X-LED³ (total 7.2 W) on flexible goosencs; brightness control	X-LED⁷³ (60-Led); brightness control
SZ-OBL	270x210x85h mm	32dia.x280h mm	95 mm dia., white disc with sample clips	None	X-LED⁷³ brightness control

SZ Series - Boom Stands

SZ-STLX



Extremely stable, long ball bearing stand complete of head holder and coarse focusing system for observation of particularly large specimens to be paired with a stereozoom head. Smooth horizontal and vertical movements are ensured and the head can be easily swivelled and tilted for inspection at oblique angles. In case illumination is needed, choose from the wide choice of external illuminators available.

Base dimensions:	: 210×255 mm
Pillar dimensions:	∅32×430 mm
Horizontal arm:	790 mm
Maximum sample height:	270 mm
Swivelling movement:	360°
Tilting movement:	180°
Weight:	16.3 kg

SZ-STL1



Extremely stable, long overhanging stand for observation of particularly large specimens to be matched with a focusing system and stereozoom head. Smooth horizontal and vertical movements are ensured and the head can be easily swivelled for inspection at oblique angles. In case illumination is needed, choose from the wide choice of external illuminators available.

Base dimensions:	230×230 mm
Pillar dimensions:	∅32×435 mm.
Horizontal arm:	415 mm
Maximum sample height:	400 mm
Swivelling movement:	360°
Weight:	14.00 kg

To be used in combination with a focusing mechanism (SZ-A1 or SZ-A6)

SZ-STL2



Extremely stable, hinged and long overhanging stand for observation of particularly large specimens to be matched with a focusing system and stereozoom head. Smooth horizontal and vertical movements are ensured and the head can be easily swivelled and tilted for inspection at oblique angles. In case illumination is needed, choose from the wide choice of external illuminators available.

Base dimensions:	260×210 mm
Pillar dimensions:	∅32×425 mm
Horizontal arm:	515 mm
Maximum sample height:	440 mm
Swivelling movement:	360°
Tilting movement:	180°
Weight:	18.8 kg

To be used in combination with a focusing mechanism (SZ-A1 or SZ-A6)

SZ Series - Boom Stands / Flat Industrial Stands

SZ-STL5



Highly versatile flexible arm stand, 360°rotating, ideal for industrial applications. It comes complete of head holder with focusing system and all the supports for table clamp. Small footprint is ensured when not in use, saving valuable space on the bench. Table clamp included.

Total height : 330 mm

Total depth: 880 mm

Horizontal arm: 820 mm

Weight: 4.8 kg

SZ-STL5LED



Highly versatile flexible arm stand, 360°rotating, ideal for industrial applications. It comes complete of the settable and exclusive X-LED3 incident illumination system, head holder with focusing system and all the supports for table clamp. Small footprint is ensured when not in use, saving valuable space on the bench. Multi-plug 100-240Vac/6Vdc external power supply. Head shown in picture not included

Total height : 330 mm

Total depth: 880 mm

Horizontal arm: 820 mm

Illuminators: 2x X-LED3 on gooseneck, with brightness control unit

Power supply: Multi-plug 100/240Vac, 50-60Hz; output 12Vdc, 1.5A

Weight: 5.7 kg

ST-150 / ST-152

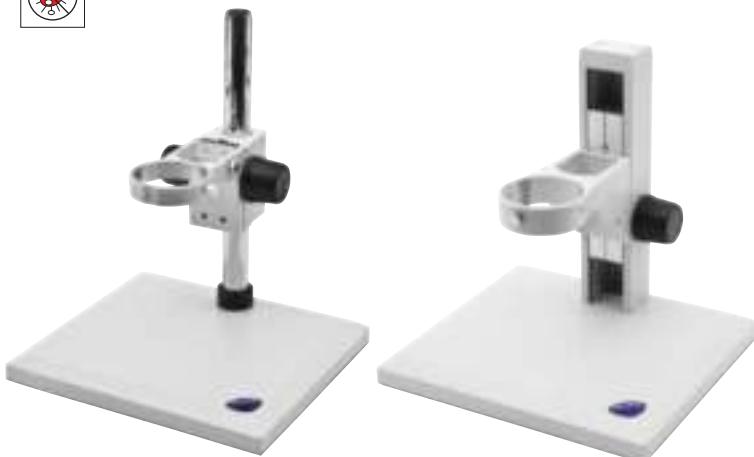

Large, simple plain stand with head holder and focusing mechanism.

ST-150: with pillar;

ST-152: with fixed arm.

Base dimensions: 320x290 mm

Pillar dimensions (ST-150): Ø32x410 mm

Fixed arm height (ST-152): 410 mm

SZ Series - Focusing Mechanisms

SZ-A1



Entry-level coarse focusing to raise or lower the head to focus
 Coarse focusing system (76 mm head holder, 32 mm pillar) with adjustable tension for standard stereomicroscope requirements.

Type: Coarse
Coarse total travel: 50 mm
Adjustable tension: Yes
Head holder internal diameter: 76 mm
Pillar diameter: 32 mm

SZ-A6



Coaxial coarse and fine focusing results in easy, precise conditions
 Coaxial coarse and fine focusing system (76 mm head holder, 32 mm pillar) with 2 µm fine resolution and adjustable tension ideal for extremely precise fine adjustments and smooth movements.

Type: Coaxial coarse and fine
Coarse total travel: 50 mm
Fine total travel (per single rotation): 0.2 mm.
Fine graduations: 100
Fine resolution: 2 µm
Adjustable tension: Yes
Head holder internal diameter: 76 mm
Pillar diameter: 32 mm

SZ Series - Best Selling Configurations



SZO-B + SZ-A1 + SZ-ST1



SZX-B + SZ-A1 + SZ-ST3



SZX-BA + SZ-A1 + SZ-ST7

SZ Series - Optical Performance

SZX-B and SZX-T Heads

Eyepiece	10x (ST-141)		15x (ST-302)		20x (ST-303)		25x (ST-144)	
Field number (mm)	22		16		12		9	
Objective	Total magnification	Field of View (mm)	Total magnification	Field of View (mm)	Total magnification	Field of View (mm)	Total magnification	Field of View (mm)
0.3x (W.D: 241 mm)	2.01x-13.5x	109.45-16.30	3.02x-20.25x	79.60-11.85	4.02x-27x	59.70-8.89	5.02x-33.75x	44.78-6.67
0.5x (W.D: 160 mm)	3.35x-22.5x	65.67-9.78	5.02x-33.75x	47.76-7.11	6.7x-45x	35.82-5.33	8.37x-56.25x	26.87-4.0
0.75x (W.D: 116 mm)	5.02x-33.75x	43.78-6.52	7.54x-50.62x	31.84-4.74	10.05x-67.5x	23.88-3.56	12.56x-84.37x	17.91-2.67
1x (W.D: 100 mm)	6.7x-45x	32.84-4.89	10.05x-67.5x	23.88-3.56	13.4x-90x	17.91-2.67	16.75x-112.5x	13.43-2.0
1.5x (W.D: 44 mm)	10.05x-67.5x	21.89-3.26	15.07x-101.25	15.92-2.37	20.1x-135x	11.94-1.78	25.12x-168.75x	8.96-1.33
2x (W.D: 26 mm)	13.4x-90.0x	16.42-2.44	20.1x-135x	11.94-1.78	26.8x-180x	8.96-1.33	33.5x-225x	6.72-1.0

SZX-BA and SZX-TA Heads

Eyepiece	10x (ST-306)		15x (ST-302)		20x (ST-303)		25x (ST-144)	
Field number (mm)	23		16		12		9	
Objective	Total magnification	Field of View (mm)	Total magnification	Field of View (mm)	Total magnification	Field of View (mm)	Total magnification	Field of View (mm)
0.3x (W.D: 228 mm)	1.95x-15.5x	117.95-13.94	2.93x-23.25x	82.05-9.70	3.9x-31.0x	61.54-7.27	4.88x-38.75x	46.15-5.45
0.5x (W.D: 164 mm)	3.25x-27.5x	70.77-8.36	4.88x-41.25x	49.23-5.82	6.5x-55x	36.92-4.36	8.13x-68.75x	27.69-3.27
0.75x (W.D: 109 mm)	4.87x-41.25x	47.18-5.58	7.31x-61.88x	32.82-3.88	9.74x-82.5x	24.62-2.91	12.18x-103.13x	18.46-2.18
1x (W.D: 102 mm)	6.5x-55x	35.38-4.18	9.75x-82.5x	24.62-2.91	13.0x-110x	18.46-2.18	16.25x-137.5x	13.85-1.64
1.5x (W.D: 46 mm)	9.75x-82.5x	23.59-2.79	14.63x-123.75	16.41-1.94	19.5x-165x	12.31-1.45	24.38x-206.25x	9.23-1.09
2x (W.D: 26 mm)	13.0x-110.0x	17.69-2.09	19.5x-165x	12.31-1.45	26.0x-210x	9.23-1.09	32.5x-262.5x	6.92-0.82

SZO-B and SZO-T Heads

Eyepiece	10x (ST-301)		15x (ST-302)		20x (ST-303)		25x (ST-144)	
Field number (mm)	23		16		12		9	
Objective	Total magnification	Field of View (mm)	Total magnification	Field of View (mm)	Total magnification	Field of View (mm)	Total magnification	Field of View (mm)
0.3x (W.D: 287 mm)	2.01x-13.5x	114.43-17.04	3.02x-20.25x	79.60-11.85	4.02x-27x	59.70-8.89	5.02x-33.75x	44.78-6.67
0.5x (W.D: 177 mm)	3.35x-22.5x	68.66-10.22	5.02x-33.75x	47.76-7.11	6.7x-45x	35.82-5.33	8.37x-56.25x	26.87-4.0
0.75x (W.D: 120 mm)	5.02x-33.75x	45.77-6.81	7.54x-50.62x	31.84-4.74	10.05x-67.5x	23.88-3.56	12.56x-84.37x	17.91-2.67
1x (W.D: 110 mm)	6.7x-45x	34.33-5.11	10.05x-67.5x	23.88-3.56	13.4x-90x	17.91-2.67	16.75x-112.5x	13.43-2.0
1.5x (W.D: 47 mm)	10.05x-67.5x	22.89-3.41	15.07x-101.25	15.92-2.37	20.1x-135x	11.94-1.78	25.12x-168.75x	8.96-1.33
2x (W.D: 26 mm)	13.4x-90.0x	17.16-2.56	20.1x-135x	11.94-1.78	26.8x-180x	8.96-1.33	33.5x-225x	6.72-1.0

SZ Series - Best Selling Configurations



SZO-T + SZ-A1 + SZ-STL1



SZO-T + SZ-A1 + SZ-STL2

SZ Series - Accessories

Eyecups & Eyepieces

- ST-141 WF10x/22 eyepieces (pair), high eyepoint, focusable, rubber cup
(only for SZX-B & SZX-T)
- ST-145 WF10x/22 micrometric eyepiece, high eyepoint, focusable, rubber cup
(only for SZX-B & SZX-T)
- ST-144 WF25x/9 eyepieces (pair), high eyepoint, focusable, with rubber cup
- ST-301 WF10x/23 eyepieces (pair), high eyepoint, focusable, with rubber cup
(only for SZO-B & SZO-T)
- ST-302 WF15x/16 eyepieces (pair), high eyepoint, focusable, with rubber cup
- ST-303 WF20x/12 eyepieces (pair), high eyepoint, focusable, with rubber cup
- ST-305 WF10x/23 micrometric eyepiece, high eyepoint, focusable, rubber cup
(only for SZO-B & SZO-T)
- ST-306 WF10x/23 eyepieces (pair), high eyepoint, focusable, rubber cup
(only for SZX-BA & SZX-TA)
- ST-310 WF10x/23 micrometric eyepiece, high eyepoint, focusable, rubber cup
(only for SZX-BA & SZX-TA)

Additional Lenses

- ST-102 Additional lens 0.3x
- ST-103 Additional lens 0.5x
- ST-104 Additional lens 0.75x
- ST-105 Additional lens 1.5x
- ST-106 Additional lens 2x

Stages

- ST-100 Hand moving stage, for insert diameter of 95 mm
- ST-110 Moving stage, coaxial knobs, for insert diameter of 95 mm
- ST-111 Moving stage, micrometric screws, for insert diameter of 95 mm
- ST-666 Applicable heating stage, for insert diameter of 95 mm, multiplug

Condenser & Filters

- ST-040 Darkfield condenser, 95mm diameter
- ST-088 Polarising set (filters and rotating stage), 95mm diameter

Camera Adapters

- M-113.1 Ring adapter, 30mm (for monocular and binocular microscopes)
- M-115 0.35x C-Mount projection lens
- M-114 0.5x C-Mount projection lens
- M-118 0.75x C-Mount projection lens
- M-173 C-Mount projection lens for APS-C/full frame reflex cameras (trino)
- M-699 Universal adapter for C-Mount projection lens (trino)
- M-620 0.35x focusable C-Mount adapter
- M-620.1 0.5x focusable C-Mount adapter
- M-620.2 0.65x focusable C-Mount adapter
- M-620.3 1x focusable C-Mount adapter

Miscellaneous

- 15104 Cleaning kit
- DC-002 Plastic dust cover, medium, 490(l)x490(h) mm
- DC-003 TNT dust cover, medium, 600(l)x550(h) mm
- DC-004 TNT dust cover, large, 700(l)x550(h) mm
- M-005 Micrometric slide, 26x76mm, with 2 scales (1mm/100 & 10mm/100)
- M-069 Solar charger
- ST-014 Glass object-plate, 95mm diameter
- ST-041 Sample clip
- ST-092 Protective glass for stereohead
- VP-SZ IQ/OQ/PQ manual for SZ series
- AB-010 Antibacterial surface treatment, only for newly purchased microscope
(Only for SZO-B & SZO-T)
- AB-020 Antibacterial surface treatment, only for newly purchased microscope

ST-100



ST-110



ST-111



ST-666



How to connect the cameras to our microscopes.

Please refer to the Adapter reference list on Digital section.

v 7.5 - OPTIKA reserves the right to make corrections, modifications, enhancements, improvements and other changes to its products at any time without notice.

Headquarters and Manufacturing Facilities

OPTIKA® S.r.l. Via Rigla, 30 - 24010 Ponteranica (BG) - ITALY - Tel.: +39 035.571.392 - info@optikamicroscopes.com

Optika Sales branches

OPTIKA® Spain spain@optikamicroscopes.com
OPTIKA® China china@optikamicroscopes.com
OPTIKA® India india@optikamicroscopes.com

OPTIKA® North America namerica@optikamicroscopes.com
OPTIKA® Central America camerica@optikamicroscopes.com
OPTIKA® Africa africa@optikamicroscopes.com

OPTIKA[®]
M I C R O S C O P E S
I T A L Y

SZP Series



Advanced CMO Stereozoom Microscopes



SZP Series

Greenough Vs. CMO Stereo Microscopes

The Greenough design, introduced in the early twentieth century, consists of two identical, symmetrical optical systems each containing a separate eyepiece and objective, arranged in careful alignment with a single housing. The two optical paths are arranged at a precise angle, due to which they converge to the point that determines the working distance and thus the focal length. This design allows high numerical apertures because the objectives are very similar to those used in compound microscopes. The lower section of the microscope contains the objectives, while the upper end of the body tubes projects an image to the eyes.

CMO (Common Main Objective) stereo microscopes have



CMO Stereozoom Microscopes

the ability to collect more light than the Greenough design and feature greater optical aberration correction.

CMO stereo microscopes, unlike Greenough stereo microscopes, are by definition instruments whose optics are infinity corrected. This allows you to easily introduce accessories such as beamsplitters or aperture diaphragms thanks to which you can get a greater depth of field.

ST-172

Get the most out of our accessories

ST-172 - Iris diaphragm module

With this accessory, the depth of field of the final image can be adjusted, for applications where different planes all in focus are needed.

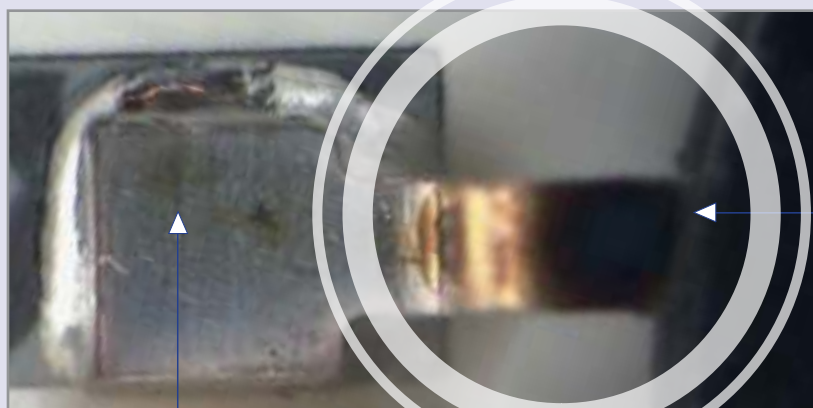

OUT-OF-FOCUS AREA

With iris diaphragm open

FOCUS PLANE

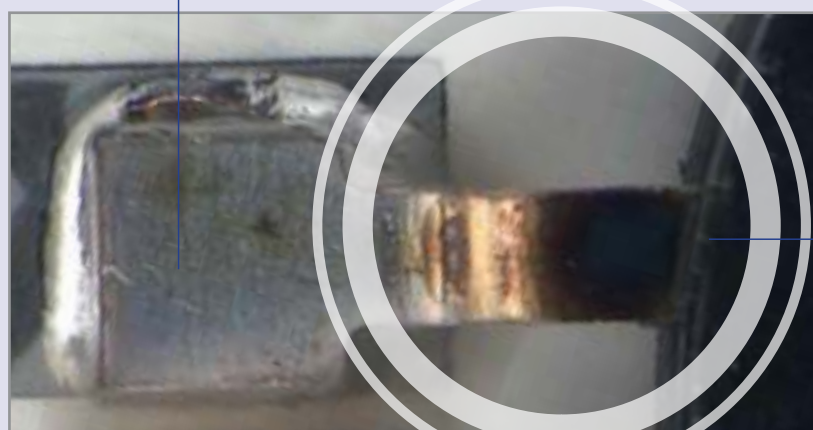

IN-FOCUS AREA

With iris diaphragm close

Soldered Led Pin - SZP-8 with iris diaphragm module and ST-156 stand.



SZP Series - Heads

SZP-6, SZP-8, SZP-10

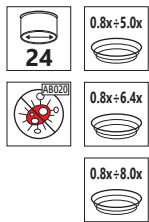

Part	Description
Head:	Binocular, 360° rotating on all stands and 30° inclined.
Interpup. distance:	Adjustable between 52 and 75 mm.
Dioptric adjustment:	On both eyepieces.
Eyepieces:	WF10x/24 mm, high eye-point.
SZP-6 zoom body:	Parfocal achromatic zoom 0.8x...5.0x (zoom factor 6.25:1).
SZP-8 zoom body:	Parfocal achromatic zoom 0.8x...6.4x (zoom factor 8:1).
SZP-10 zoom body:	Parfocal achromatic zoom 0.8x...8.0x (zoom factor 10:1).
Zoom positioning:	By click-stop mechanism
Objective lens:	Plan Achromatic 1x.
Working distance:	80 mm.
Optical system:	Galilean (Parallel, infinity corrected).



SZP-6e, SZP-8e, SZP-10e

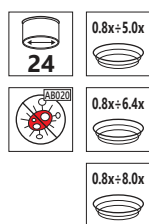

Part	Description
Head:	Ergonomical binocular, 360° rotating on all stands and freely inclinable from 0° to 35°.
Interpup. distance:	Adjustable between 55 and 80 mm.
Dioptric adjustment:	On both eyepieces.
Eyepieces:	WF10x/24 mm, high eye-point.
SZP-6e zoom body:	Parfocal achromatic zoom 0.8x...5.0x (zoom factor 6.25:1).
SZP-8e zoom body:	Parfocal achromatic zoom 0.8x...6.4x (zoom factor 8:1).
SZP-10e zoom body:	Parfocal achromatic zoom 0.8x...8.0x (zoom factor 10:1).
Zoom positioning:	By click-stop mechanism
Objective lens:	Plan Achromatic 1x.
Working distance:	80 mm.
Optical system:	Galilean (Parallel, infinity corrected).



SZP-FL - Epi-Fluorescence Attachment

Attachment for fluorescence applications for SZP stereomicroscopes only.

Used in many applications like biology, botany, electronics, materials, forensics. Equipped with HBO 100W mercury lamp illuminator.
To be combined with any SZP model.



Name	Excitation filter (nm)	Dichroic mirror cut-off (nm)	Emission filter (nm)
B Blue	460 - 500	505	510LP
G Green	510 - 550	570	575LP

SZP-FL HBO fluorescence attachment for SZP heads

Description: SZP fluorescence attachment for biology, industrial inspection, forensics, etc. Essential tool for security printing and mineral research.

Illumination: 100W HBO high-pressure mercury bulb. Average lamp lifetime: 400 hours. Input voltage: 110/240Vac, 50/60Hz, 1A ; Fuse: F8AL 250V. Maximum input power: 125W. Current and time counter LED displays.

Photo Attachment: Trinocular output Photo/Video port.

SZP Series - Stands

ST-155

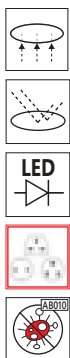

Modern, large plain stand equipped with **LED transmitted and incident illumination**, both with **intensity control**. It comes complete of head holder and focusing mechanism.
 Base size: 330x290 mm. Height: 40 mm. Fixed arm height: 340 mm.
 Head not included.



ST-156

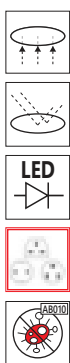

Modern, large plain stand equipped with **LED transmitted and incident illumination**, both with **intensity control**. It comes complete of head holder and **coaxial coarse and fine focusing system**. Base size: 330x290 mm. Height: 40 mm.
 Fixed arm height: 340 mm. Head not included.



SZP Series - Optical Performance

SZP Heads

Optical performance SZP-6 / SZP-6e

Eyepiece	10x (ST-160)		15x (ST-161)		20x (ST-162)	
Field number (mm)	24		15		10	
Objective	Total magnification	Field of View (mm)	Total magnification	Field of View (mm)	Total magnification	Field of View (mm)
0.3x (W.D: 280 mm)	2.4x-15x	100.00-16.00	3.6x-22.5x	62.50-10.00	4.8x-30x	41.67-6.67
0.5x (W.D: 165 mm)	4x-25x	60.00-9.60	6x-37.5x	37.50-6.00	8x-50x	25.00-4.00
1x (W.D: 80 mm)	8x-50x	30-4.80	12x-75x	18.75-3.00	16x-100x	12.50-2.00
2x (W.D: 32.5 mm)	16x-100x	15-2.40	24x-150x	9.38-1.50	32x-200x	6.25-1.00

Optical performance SZP-8 / SZP-8e

Eyepiece	10x (ST-160)		15x (ST-161)		20x (ST-162)	
Field number (mm)	24		15		10	
Objective	Total magnification	Field of View (mm)	Total magnification	Field of View (mm)	Total magnification	Field of View (mm)
0.3x (W.D: 280 mm)	2.4x-19.2x	100.00-12.50	3.6x-28.8x	62.50-7.81	4.8x-38.4x	41.67-5.21
0.5x (W.D: 165 mm)	4x-32x	60.00-7.50	6x-48x	37.50-4.69	8x-64x	25.00-3.13
1x (W.D: 80 mm)	8x-64x	30.00-3.75	12x-96x	18.75-2.34	16x-128x	12.50-1.56
2x (W.D: 32.5 mm)	16x-128x	15.00-1.88	24x-192x	9.38-1.17	32x-256x	6.25-0.78

Optical performance SZP-10 / SZP-10e

Eyepiece	10x (ST-160)		15x (ST-161)		20x (ST-162)	
Field number (mm)	24		15		10	
Objective	Total magnification	Field of View (mm)	Total magnification	Field of View (mm)	Total magnification	Field of View (mm)
0.3x (W.D: 280 mm)	2.4x-24x	100.00-10.00	3.6x-36x	62.50-6.25	4.8x-48x	41.67-4.17
0.5x (W.D: 165 mm)	4x-40x	60.00-6.00	6x-60x	37.50-3.75	8x-80x	25.00-2.50
1x (W.D: 80 mm)	8x-80x	30.00-3.00	12x-120x	18.75-1.88	16x-160x	12.50-1.25
2x (W.D: 32.5 mm)	16x-160x	15.00-1.50	24x-240x	9.38-0.94	32x-320x	6.25-0.63

SZP Series - Accessories

Eyepieces & Eyepieces

- ST-160 WF10x/24 eyepiece, high eyepoint, focusable, with rubber cup
- ST-161 WF15x/16 eyepieces (pair), focusable, with rubber cup
- ST-162 WF20x/12 eyepieces (pair), focusable, with rubber cup
- ST-163 WF10x/24 micrometric eyepiece, high eyepoint, focusable, rubber cup

Additional Lenses

- ST-165 0.3x objective (w.d. 280mm)
- ST-166 0.5x objective (w.d. 118mm)
- ST-167 2x objective (w.d. 32.5mm)

Camera Adapters

- M-113.1 Ring adapter, 30mm (for monocular and binocular microscopes)
- M-115 0.35x C-Mount projection lens
- M-114 0.5x C-Mount projection lens
- M-118 0.75x C-Mount projection lens
- M-173 C-Mount projection lens for APS-C/full frame reflex cameras (trino)
- M-699 Universal adapter for C-Mount projection lens (trino)
- M-620 0.35x focusable C-Mount adapter
- M-620.1 0.5x focusable C-Mount adapter
- M-620.2 0.65x focusable C-Mount adapter
- M-620.3 1x focusable C-Mount adapter

Miscellaneous

- 15104 Cleaning kit
- DC-002 Plastic dust cover, medium, 490(l)x490(h) mm
- DC-003 TNT dust cover, medium, 600(l)x550(h) mm
- DC-004 TNT dust cover, large, 700(l)x550(h) mm
- M-005 Micrometric slide, 26x76mm, with 2 scales (1mm/100 & 10mm/100)
- M-151 HBO 100W high-pressure mercury bulb for fluorescence
- M-151.1 HBO 100W high-pressure mercury bulb for fluorescence (OSRAM)
- ST-098 Polarising set (filters and rotating stage)
- ST-170 Photo/Video beam splitter - 1 port
- ST-171 Photo/Video beam splitter - 2 port
- ST-172 Iris diaphragm module
- ST-176 Protective glass for stereohead (only works with standard 1x lens)
- SZP-FL HBO fluo attachment, 3-pos. (B & G filter set), multi-plug
- VP-SZP IQ/OO/PQ manual for SZP series
- AB-020 Antibacterial surface treatment, only for newly purchased microscope



ST-172



ST-170



ST-171



ST-098

15104 - Cleaning kit

It cleans glass quickly and effectively, without leaving residue or odor. Ideal for precision lens or prism cleaning.



How to connect the cameras to our microscopes.

Please refer to the Adapter reference list on Digital section.

v 7.5 - OPTIKA reserves the right to make corrections, modifications, enhancements, improvements and other changes to its products at any time without notice.

Headquarters and Manufacturing Facilities

OPTIKA® S.r.l. Via Rigla, 30 - 24010 Ponteranica (BG) - ITALY - Tel.: +39 035.571.392 - info@optikamicroscopes.com

Optika Sales branches

OPTIKA® Spain spain@optikamicroscopes.com
OPTIKA® China china@optikamicroscopes.com
OPTIKA® India india@optikamicroscopes.com

OPTIKA® North America namerica@optikamicroscopes.com
OPTIKA® Central America camerica@optikamicroscopes.com
OPTIKA® Africa africa@optikamicroscopes.com

CL Series



Cold Light Illuminators

CLD-01



Flexible and professional cold light illuminator with high power, extra-efficiency 14W LED system, extremely bright and uniform. Optical power: >1000 lumen. Color temperature: pure white 6,300 K. Brightness control potentiometer, external power supply.



CLD-01 with CL-11.1



CL-17.1: Additional polarizing filters for CL-11.1

CLD-01 Accessories

The output can be coupled to the following accessories:

- CL-11.1: Double-arm optical fiber guide with focusing lenses. Arm length 500 mm.
- CL-17.1: Polarizing filters (pair) for CL-11.1.
- CL-12: Ring optical fiber guide (length 700 mm). Guide diameter 16 mm. Diameter of the fixing ring: 55mm. The circular end is suitable for all stereo series.

CL-11.1

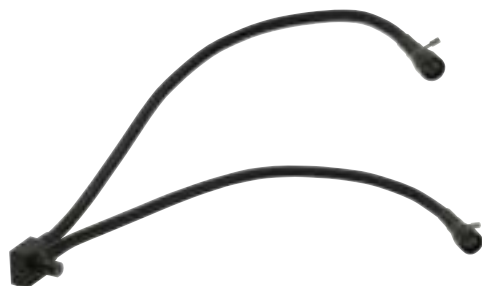

Double-arm guide for CLD-01, with focusing lenses.
 Arm length 500 mm. Each arm fitted with focusable lens adapter.
Illuminance (at 10 cm distance): 100.000 lux.
 Optional accessory:
CL-17.1: Polarizing filters (pair) for CL-11.1.

CL-12



Ring optical fiber guide for CLD-01.
 Length 700 mm, diameter 16 mm.
 The circular end is suitable for all series, by using the three locking screws. Diameter of the fixing ring: 55 mm.
Illuminance (at 10 cm distance): 40,000 lux.

CL Series - Illuminators

CL-32



- Arms with magnetic coupling
- Two selectable light intensities
- Rechargeable batteries
- Focusable light spot

Arm illuminator with magnetic fixing plate, USB powered.

Light sources: LED; With 2W high efficiency LED.

Color temperature: pure white 6,300 K;

Luminous flux: 200 lm;

Illuminance: 20,000 (on 5 cm diameter).

CL-33



Pair of arm illuminators with magnetic fixing plates, metal base, USB.

Light sources: LED; With 2W high efficiency LEDs.

Color temperature: pure white 6,300 K;

Luminous flux: 200 lm (x2);

Illuminance: 20,000 (on 5 cm diameter) (x2).



CL-32/CL-33 quick connection

- place the adhesive disk in the preferred position on the instrument



- magnetically connect the arm and remove it for every need



CL-41



Double-arm X-LED³ illuminator, with brightness control.

Light sources: With 3,6 W high efficiency X-LED³.

Color temperature: pure white 6,300 K;

Luminous flux: 400 lm each arm;

Illuminance: 170,000 lux (at 10 cm distance).

Multi-plug 100-240Vac/12Vdc external power supply.

CL Series - Illuminators

CL-14



56-LED ring light illuminator, with brightness control.

Compact, with 360° rotating ring connector.
Illuminance (at 10 cm distance): >8,000 lux.

CL-16.1



Professional lighting system including 144 LEDs (2W total power) for enhanced light uniformity and brightness. The ring light illumination is divided into 4 different zones, individually adjustable for **selectable light zones**. The **separated, external control panel** prevents interferences during use, whilst the sturdy metal structure makes it **more durable and resistant**.

Diameter of the fixing ring: 60mm.
Color temperature: pure white 6,300 K.
Illuminance: 6,000 lux (at 10 cm distance).

CL-18



Professional lighting system including 96 LEDs for enhanced light uniformity and brightness, and **built-in rotating polarizing filter** and analyzer filters for complete polarization, ideal to reduce glares and reflections when viewing metallic parts.

Provided with **on-board intensity level adjustment**.

Diameter of the fixing ring: 60mm.
Color temperature: pure white 6,300 K.
Illuminance: 9,000 lux (at 10 cm distance).

v 7.5 - OPTIKA reserves the right to make corrections, modifications, enhancements, improvements and other changes to its products at any time without notice.

Headquarters and Manufacturing Facilities

OPTIKA® S.r.l. Via Rigla, 30 - 24010 Ponteranica (BG) - ITALY - Tel.: +39 035.571.392 - info@optikamicroscopes.com

Optika Sales branches

OPTIKA® Spain spain@optikamicroscopes.com
OPTIKA® China china@optikamicroscopes.com
OPTIKA® India india@optikamicroscopes.com

OPTIKA® North America namerica@optikamicroscopes.com
OPTIKA® Central America camerica@optikamicroscopes.com
OPTIKA® Africa africa@optikamicroscopes.com

OPTIKA[®]
M I C R O S C O P E S
I T A L Y

GEM Series



Stereozoom Microscopes For Gemology

GEM Series

As a leading company in the supply of gemological microscopes, OPTIKA offers a series of microscopes purposely designed for this sector by using both brightfield and darkfield methods OPTIGEM-10 and OPTIGEM-20. This series has been designed and manufactured in order to satisfy the requests of a very demanding industry; brightfield/darkfield, immersion analysis, light color temperature: no detail has been left to chance.

Specifically Designed for Specialists

Gemological stereomicroscopes are meant to help with stone inspection. Jewels and gems have a variety of grades (or quality levels), which ultimately influence their value and cost on the market; therefore it is important to have solutions that are purposely designed for gemology. These stereomicroscopes are equipped with iris and darkfield condenser on the bottom light source, and with a set of on stage tweezers to hold the stone in place.

Much More Than Gemological Stereomicroscopes

OPTIGEM-10 & OPTIGEM-20 are two-in-one gemology instruments that can be used both in vertical and horizontal position in a very easy way, just by turning one knob (no disassembling and re-assembling operations are required). The horizontal position extends the use of a gemological microscope, giving the possibility to perform immersion analysis by submerging a sample in liquid. If the stone's refractive index is close to the liquid's one, immersion makes the interior more visible by reducing the effects of refraction and surface reflection. This enables you to see a gem's inclusions or color distribution more easily.

Immersion is also necessary to see crystal growth structures, which might help you separate natural from synthetic corundum. Features like curved growth striae in flame-fusion synthetics, or separation planes in assembled stones, are often far easier to see when the stone is immersed.



Vertical position for standard gem analysis with darkfield illumination and polarizing technique



Horizontal position for immersion gem analysis

Incredibly Versatile Operations

OPTIGEM Series offers multiple options for illumination and contrast techniques, such as incident, transmitted and oblique brightfield darkfield, polarization and immersion analysis only on Optigem 10 & 20. They come with a special optical condenser configuration to ensure real, perfect darkfield application (see the dedicated chapter for further information).



Stereozoom Microscopes For Gemology

Ultrabright LED Condenser for Optimized Illumination

An ultrabright LED-based electronic condenser with intensity control allows to switch from brightfield to darkfield; it also produces perfectly the colour of daylight. The condenser uses a new optical configuration especially created in order to obtain a perfect darkfield application.

With darkfield observation, the unscattered beams from the image are excluded: as a result, the field around the specimen is generally dark. An additional flexible arm and velvet-field slider produce extra contrast for crisp and vibrant images. The illumination of OPTIGEM microscopes is greatly performing and this brings this series to be ideal for precious stones and jewels evaluation.

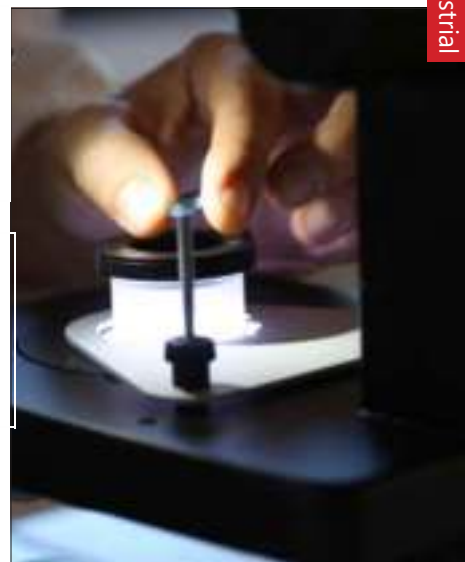

Get the most out of our accessories

A wide range of optional accessories completes these instruments: from gemology clip, iris aperture diaphragm, polarization analysis kit, optical unit to switch the darkfield from a "sharp" (gem exhibition) to a "soft" (diamond analysis) mode, translating cell holder with vacuum pick-up and quartz immersion cells complete and enhance the OPTIGEM-10 & OPTIGEM-20 performances. All the accessories can be stacked, in any order, while using the microscope both horizontally and vertically.

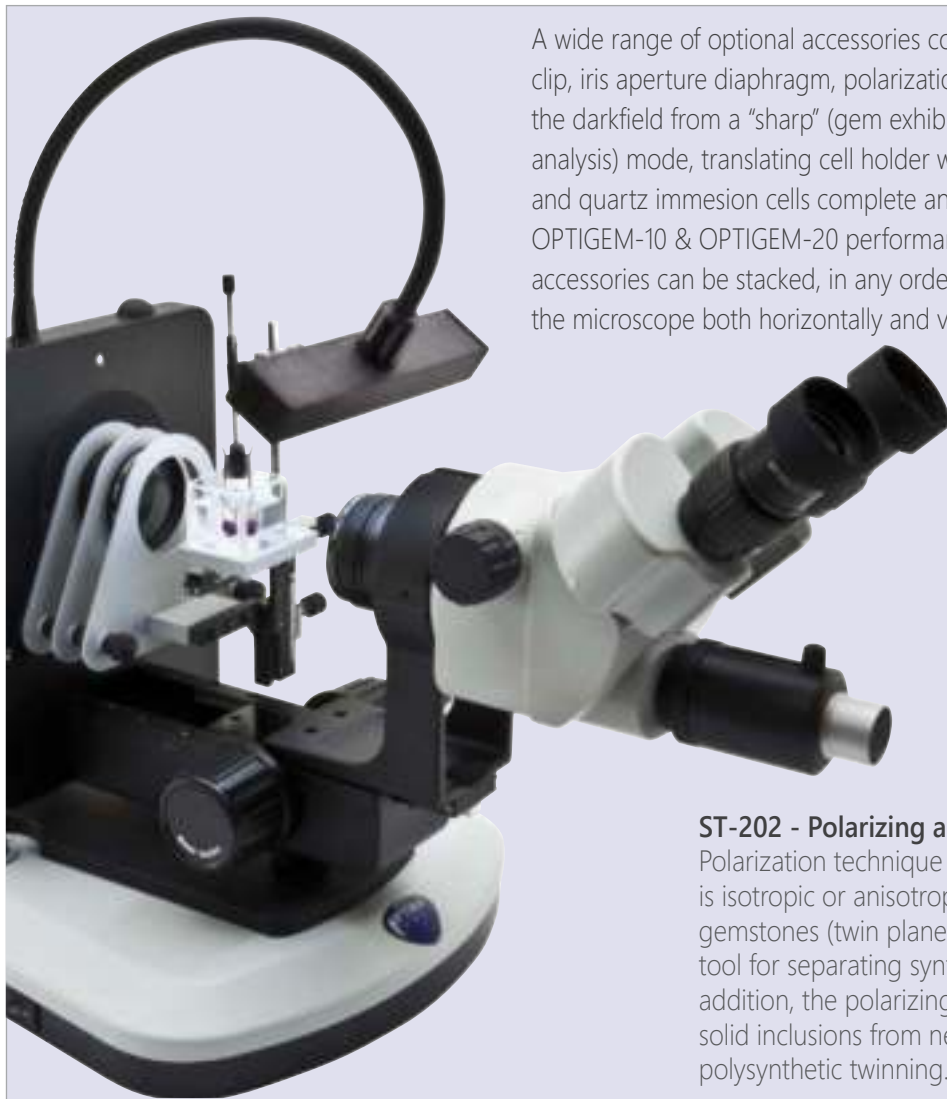

ST-202

ST-202 - Polarizing analysis kit

Polarization technique allows to quickly determine if the stone at hand is isotropic or anisotropic or, at best, to determine the optic character of gemstones (twin planes, strain, pleochroism, etc.). It is also the preferred tool for separating synthetic Quartz from its natural counterparts. In addition, the polarizing microscope may be very useful for distinguishing solid inclusions from negative inclusions as well as for spotting polysynthetic twinning.

GEM Series

Applications

Some application examples demonstrating the performance of OPTIGEM Series, especially designed to observe samples of precious stones and jewels and provided with specific features for gemological needs.

Legend

1. Inspection of stones with OPTIGEM-10.
2. Inspection of stones with pure white darkfield illumination.
3. Immersion cell (ST-203) on a translating support (ST-204).
4. Sample of Citrine.
5. ST-201 accessory creates a soft darkfield illumination ideal for diamond analysis.
6. Optigem can be easily rotated to a horizontal working position.
7. ST-201 accessory for analysis under polarized light.
8. Working with Optigem and its accessories (they can be stacked for increased functionality).

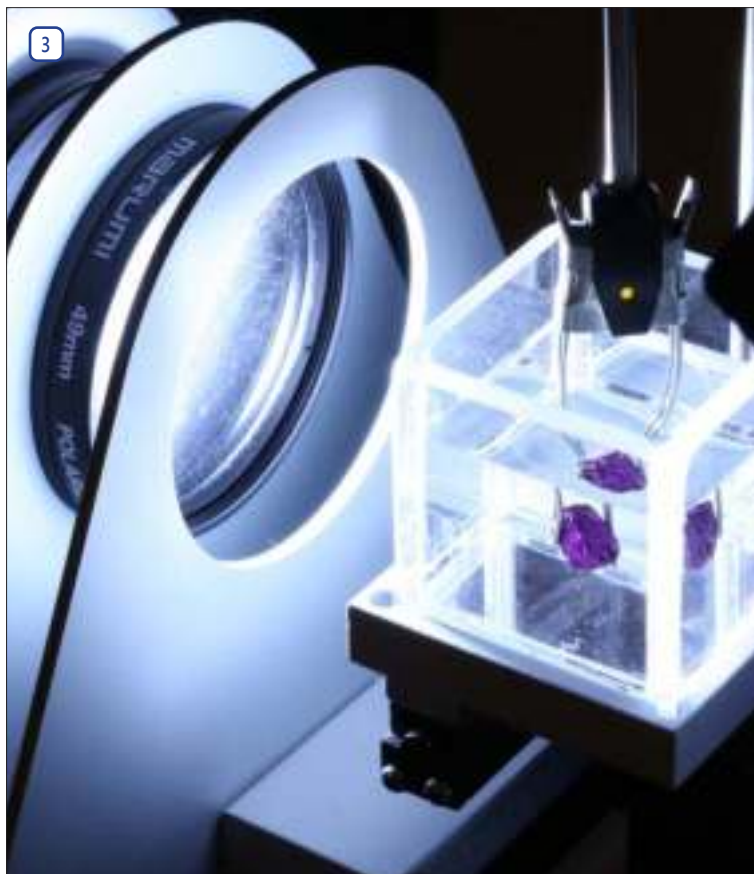
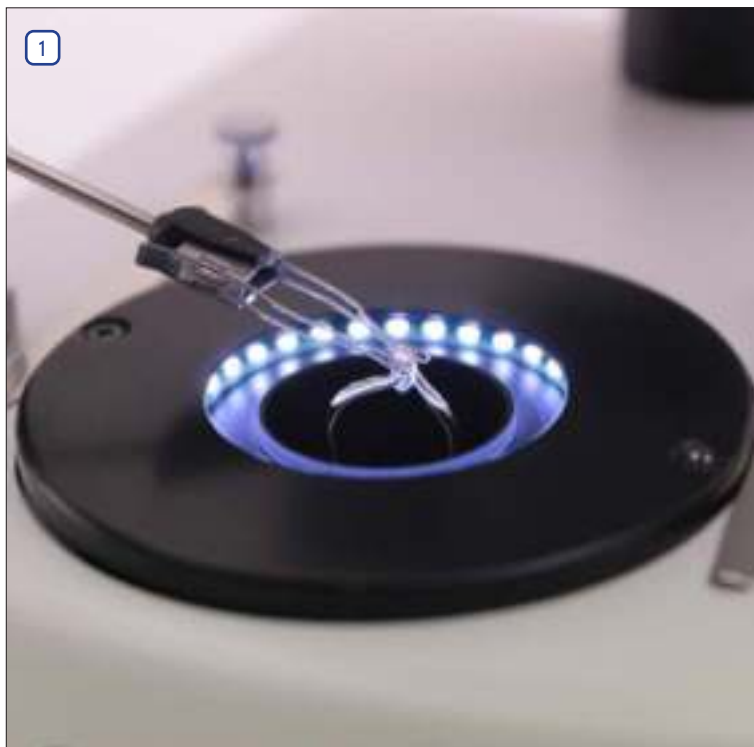

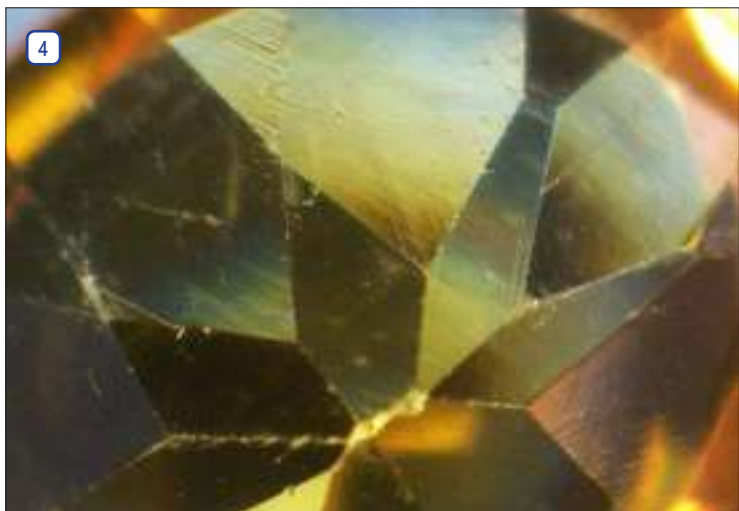

GEM Series - OPTIGEM10 model

Binocular gemological stereomicroscopes for brightfield and darkfield applications with special side-emitting **LED** illumination ring for true darkfield illumination. Equipped also with **4 incident LED** flexible arm and a diffusive **LED** disc for transmitted illumination. The instrument can be easily tilted horizontally for immersion analysis.



Part	Description
Observation mode:	Brightfield, darkfield.
Heads	Binocular, 45° inclined, 360° rotating.
Interpupillary distance:	Adjustable between 51 and 75 mm
Dioptric adjustment:	On both eyepiece tubes.
Eyepieces:	WF10x/21 mm, high eye-point.
Objective:	Parfocal achromatic zoom 0.7x...4.5x (zoom factor 6.43:1).
Working distance:	100 mm
Specimen stage:	Gemological stage, with clamp for holding gems.
Focusing:	Rack and pinion mechanism controlled by a pair of knobs.
Stand:	Fixed arm stand with tilting system (with position lock control). It can be totally overturned and rotated allowing in this way to obtain a 2-in-one instrument: an instrument for standard observations and one for observation of water-immersed gems.

Part	Description
Darkfield illumination:	Equipped with a state-of-the-art illuminator for darkfield observation. It consist of an innovative side-emitting LEDs ring with an emission angle of 38°. With brightness control.
Transmitted light illumination:	Equipped with a LED illuminator, located under the stage. With brightness control.
Incident illumination:	Equipped with a flexible gooseneck-arm 4-LED illuminator. With brightness control.
Color temperature:	Pure white 6,300 K

GEM Series - OPTIGEM20 model

Trinocular gemological stereomicroscopes for brightfield and darkfield applications with special side-emitting **LED** illumination ring for true darkfield illumination. Equipped also with **4 incident LED** flexible arm and a diffusive **LED** disc for transmitted illumination. The instrument can be easily tilted horizontally for immersion analysis.



Part	Description
Observation mode:	Brightfield, darkfield.
Heads	Trinocular, 45° inclined, 360° rotating.
Interpupillary distance:	Adjustable between 51 and 75 mm
Dioptric adjustment:	On both eyepiece tubes.
Eyepieces:	WF10x/21 mm, high eye-point.
Objective:	Parfocal achromatic zoom 0.7x...4.5x (zoom factor 6.43:1).
Working distance:	100 mm
Specimen stage:	Gemological stage, with clamp for holding gems.
Focusing:	Rack and pinion mechanism controlled by a pair of knobs.
Stand:	Fixed arm stand with tilting system (with position lock control). It can be totally overturned and rotated allowing in this way to obtain a 2-in-one instrument: an instrument for standard observations and one for observation of water-immersed gems.

Part	Description
Darkfield illumination:	Equipped with a state-of-the-art illuminator for darkfield observation. It consists of an innovative side-emitting LEDs ring with an emission angle of 38°. With brightness control.
Transmitted light illumination:	Equipped with a LED illuminator, located under the stage. With brightness control.
Incident illumination:	Equipped with a flexible gooseneck-arm 4-LED illuminator. With brightness control.
Color temperature:	Pure white 6,300 K

GEM Series - Comparison chart

Model	Head	Eyepieces	Objective	Stand	Illumination
OPTIGEM-10	Binocular, 360° rotating, 45° inclined	Wide Field 10x/21mm	0.7 4.5x Zoom	Gemological stand	Incident illumination: 4 LED flexible arm with brightness adjustment. Transmitted illumination: Diffusive LED disc for observation in brightfield and side-emitting LED ring for observation in darkfield.
OPTIGEM-20	Trinocular, 360° rotating, 45° inclined	Wide Field 10x/21mm	0.7 4.5x Zoom	Gemological stand	Incident illumination: 4 LED flexible arm with brightness adjustment. Transmitted illumination: Diffusive LED disc for observation in brightfield and side-emitting LED ring for observation in darkfield.

GEM Series - Optical Performance

OPTIGEM-10 / OPTIGEM-20 - Optical performance

Eyepiece	10x (ST-081)		15x (ST-082)		20x (ST-083)	
Field number (mm)	21		15		10	
Objective	Total magnification	Field of View (mm)	Total magnification	Field of View (mm)	Total magnification	Field of View (mm)
0.5x (W.D. 165 mm)	3.5x-22.5x	60.00-9.23	5.25x-33.75x	42.86-6.67	7x-45x	28.57-4.44
0.75x (W.D. 117 mm)	5.25x-33.75x	40.00-6.22	7.875x-50.625x	28.57-4.44	10.50x-67.5x	19.05-2.96
1x (W.D. 100 mm)	7x-45x	30.00-4.66	10.5x-67.5x	21.43-3.33	14x-90x	14.29-2.22
1.5x (W.D. 47 mm)	10.50x-67.5x	20.00-3.11	15.75x-101.25x	14.29-2.22	21x-135x	9.52-1.48
2x (W.D. 33 mm)	14x-90x	15.00-2.33	21x-135x	10.71-1.67	28x-180x	7.14-1.11

GEM Series - Contrast method comparison

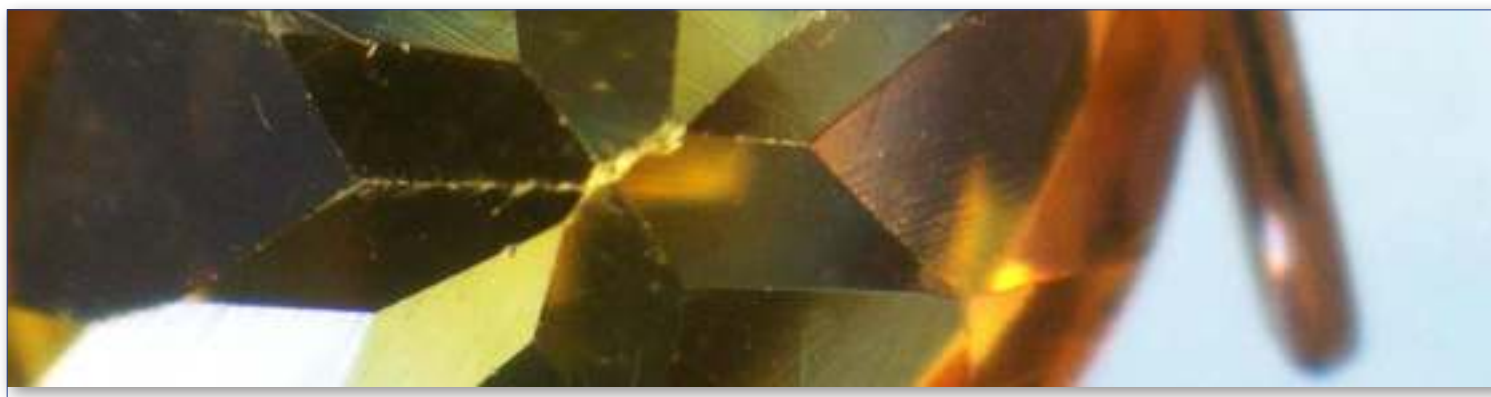

Citrine - OPTIGEM-20 - 0.7x zoom - Brightfield



Citrine - OPTIGEM-20 - 0.7x zoom - Darkfield

GEM Series - Accessories

Eyecups & Eyepieces

- ST-081 EW10x/21 eyepieces (pair), high eyepoint, with rubber cup
- ST-082 WF15x/15 eyepieces (pair), high eyepoint
- ST-083 WF20x/10 eyepieces (pair), high eyepoint
- ST-084 WF10x/21 micrometric eyepiece, high eyepoint, with rubber cup

Additional Lenses

- ST-086 Additional lens 1.5x (w.d. 45mm)
- ST-087 Additional lens 2x (w.d. 33mm)

Condenser & Filters

- ST-202 Polarizing analysis kit

Camera Adapters

- M-113.1 Ring adapter, 30mm (for monocular and binocular microscopes)
- M-115 0.35x C-Mount projection lens
- M-114 0.5x C-Mount projection lens
- M-118 0.75x C-Mount projection lens
- M-173 C-Mount projection lens for APS-C/full frame reflex cameras (trino)
- M-699 Universal adapter for C-Mount projection lens (trino)
- M-620 0.35x focusable C-Mount adapter
- M-620.1 0.5x focusable C-Mount adapter
- M-620.2 0.65x focusable C-Mount adapter
- M-620.3 1x focusable C-Mount adapter

Miscellaneous

- 15104 Cleaning kit
- DC-002 Plastic dust cover, medium, 490(l)x490(h) mm
- M-005 Micrometric slide, 26x76mm, with 2 scales (1mm/100 & 10mm/100)
- ST-092 Protective glass for stereohead
- ST-201 Iris aperture diaphragm for darkfield
- ST-203 Glass immersion cell
- ST-204 Translating cell holder
- ST-205 Vacuum pick-up (with electric vacuum pump)
- ST-207 Iris aperture diaphragm for brightfield
- AB-030 Antibacterial surface treatment, only for newly purchased microscope

15104 - Cleaning kit

It cleans glass quickly and effectively, without leaving residue or odor. Ideal for precision lens or prism cleaning.



How to connect the cameras to our microscopes.

Please refer to the Adapter reference list on Digital section.

v 7.5 - OPTIKA reserves the right to make corrections, modifications, enhancements, improvements and other changes to its products at any time without notice.

Headquarters and Manufacturing Facilities

OPTIKA® S.r.l. Via Rigla, 30 - 24010 Ponteranica (BG) - ITALY - Tel.: +39 035.571.392 - info@optikamicroscopes.com

Optika Sales branches

OPTIKA® Spain spain@optikamicroscopes.com
OPTIKA® China china@optikamicroscopes.com
OPTIKA® India india@optikamicroscopes.com

OPTIKA® North America namerica@optikamicroscopes.com
OPTIKA® Central America camerica@optikamicroscopes.com
OPTIKA® Africa africa@optikamicroscopes.com

OPTIKA[®]
M I C R O S C O P E S
I T A L Y

MET SERIES



Metallurgical Microscopes

Metallurgical Microscopy

Metallography is the study of the physical structure and components of metals, by using microscopy. Many different microscopy techniques are used in metallographic analysis.

Prepared specimens should be examined with the unaided eye after etching to detect any visible areas that have responded to the etchant differently from the norm as a guide to where microscopical examination should be employed. Light optical microscopy (LOM) examination should always be performed prior to any electron metallographic (EM) technique, as these are more time-consuming to perform and the instruments are much more expensive.

Further, certain features can be best observed with the LOM, e.g., the natural color of a constituent can be seen with the LOM but not with EM systems. Also, image contrast of microstructures at relatively low magnifications, e.g., <500X, is far better with the LOM than with the scanning electron microscope (SEM), while transmission electron microscopes (TEM) generally cannot be utilized at magnifications below about 2000 to 3000X. LOM examination is fast and can cover a large area. Thus, the analysis can determine if the more expensive, more time-consuming examination techniques using the SEM or the TEM are required and where on the specimen the work should be concentrated.

Brightfield and darkfield microscopy

Most LOM observations are conducted using bright-field (BF) illumination, where the image of any flat feature perpendicular to the incident light path is bright, or appears to be white. But, other illumination methods can be used and, in some cases, may provide superior images with greater detail. Dark-field microscopy (DF), is an alternative method of observation that provides high-contrast images and actually greater resolution than bright-field. In dark-field illumination, the light from features perpendicular to the optical axis is blocked and appears dark while the light from features inclined to the surface, which look dark in BF, appear bright, or "self-luminous" in DF. Grain boundaries, for example, are more vivid in DF than BF.

Polarized light microscopy

Polarized light (PL) is very useful when studying the structure of metals with non-cubic crystal structures (mainly metals with hexagonal close-packed (hcp) crystal structures). If the specimen is prepared with minimal damage to the surface, the structure can be seen vividly in cross-polarized light (the optic axis of the polarizer and analyzer are 90 degrees to each other, i.e., crossed). In some cases, an hcp metal can be chemically etched and then examined more effectively with PL. Tint etched surfaces, where a thin film (such as a sulfide, molybdate, chromate or elemental selenium film) is grown epitaxially on the surface to a depth where interference effects are created when examined with BF producing color images, can be improved with PL. If it is difficult to get a good interference film with good coloration, the colors can be improved by examination in PL using a sensitive tint (ST) filter.

Differential interference contrast microscopy

Another useful imaging mode is differential interference contrast (DIC), which is usually obtained with a system designed by the Polish physicist Georges Nomarski. This system gives the best detail. DIC converts minor height differences on the plane-of-polish, invisible in BF, into visible detail. The detail in some cases can be quite striking and very useful. If an ST filter is used along with a Wollaston prism, color is introduced. The colors are controlled by the adjustment of the Wollaston prism, and have no specific physical meaning, per se. But, visibility may be better.



Oblique illumination

DIC has largely replaced the older oblique illumination (OI) technique, which was available on reflected light microscopes prior to about 1975. In OI, the vertical illuminator is offset from perpendicular, producing shading effects that reveal height differences. This procedure reduces resolution and yields uneven illumination across the field of view. Nevertheless, OI was useful when people needed to know if a second phase particle was standing above or was recessed below the plane-of-polish, and is still available on a few microscopes. OI can be created on any microscope by placing a piece of paper under one corner of the mount so that the plane-of-polish is no longer perpendicular to the optical axis.

B-383MET - Metallurgical Microscope

Brightfield upright microscope with IOS W-PLAN MET objectives and metallurgical attachment combining the exclusive **X-LED³** lighting source both for incident and transmitted illumination. The NCG (no cover glass) objectives are especially designed for microscopy use without a cover slip ideal for metallographic samples and other opaque specimens.

- 20
-
-
-
-
-
-
-

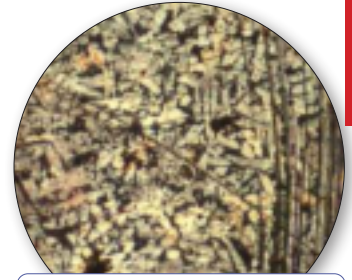

5x

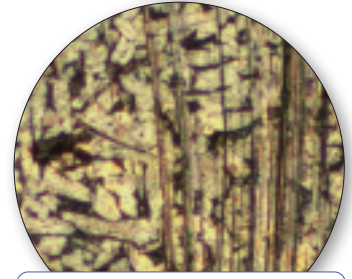

10x

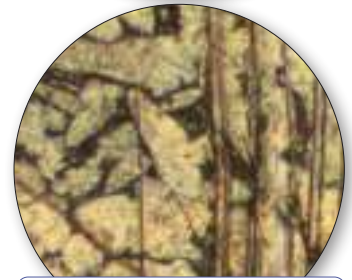

20x

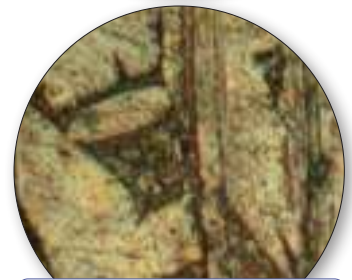

50x

Part	Description
Observation mode:	Brightfield, incident polarized light.
Epi-illumination and polarizing filters:	X-LED ³ with white 3.6 W LED (6.300 K) with brightness control. Field and aperture diaphragms, polarizer & analyzer filters.
Head:	Trinocular (fixed 50/50), 30° inclined, 360° rotating.
Interpupillary distance:	Adjustable between 48 and 75 mm.
Dioptric adjustment:	On the left eyepiece tube.
Eyepieces:	WF10x/20 mm, high eye-point and secured by screw.
Nosepiece:	Quintuple revolving nosepiece, rotation on ball bearings.

Part	Description
Objectives (strain-free):	IOS W-PLAN MET 5x/0.12 IOS W-PLAN MET 10x/0.25 IOS W-PLAN MET 20x/0.40 IOS W-PLAN MET 50x/0.75 All with anti-fungus treatment.
Specimen stage:	Double layer rackless mechanical stage, 233x147 mm, 78x54 mm X-Y range. With tempered glass plate.
Focusing:	Coaxial coarse (adjustable tension) and fine focusing mechanism with limit stop to prevent the contact between objective and specimen.
Condenser:	Abbe N.A. 1.25, with objective-coded iris diaphragm, focusable and centerable.
Transmitted illumination (Fixed Koehler type):	X-LED ³ with white 3.6 W LED (6.300 K) with brightness control. Multi-plug 100-240Vac/6Vdc external power supply.

B-510MET - Metallurgical Microscope

Advanced routine laboratory microscope with IOS W-PLAN MET objectives and metallurgical attachment with the exclusive **X-LED³** lighting source for incident illumination only. The NCG (no cover glass) objectives are especially designed for microscopy use without a cover slip ideal for metallographic samples and other opaque specimens.

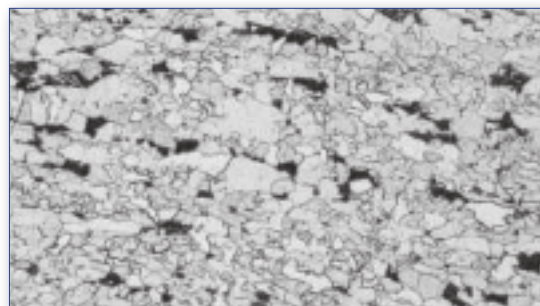

Part	Description
Observation mode:	Brightfield, simple polarized light, oblique illumination on incident light.
Epi-illumination and polarizing filters:	X-LED ³ with white 8 W LED (6.300 K) with brightness control. With aperture and field diaphragms, and oblique illumination system. With polarizer and analyzer. Multi-plug 100-240Vac/6Vdc external power supply.
Head:	Trinocular (fixed 50/50), 30° inclined, 360° rotating.
Interpupillary distance:	Adjustable between 50 and 75 mm.
Dioptric adjustment:	On the left eyepiece tube.
Eyepieces:	WF10x/22 mm, high eye-point and with rubber cups.
Nosepiece:	Quintuple revolving nosepiece, rotation on ball bearings.

Part	Description
Objectives (strain-free):	IOS W-PLAN MET 5x/0.12 IOS W-PLAN MET 10x/0.25 IOS W-PLAN MET 20x/0.40 IOS W-PLAN MET 50x/0.75 All with anti-fungus treatment.
Specimen stage:	Double layer rackless mechanical stage, 233x147 mm, 78x54 mm X-Y range.
Focusing:	Coaxial coarse (adjustable tension) and fine focusing mechanism with limit stop to prevent the contact between objective and specimen.

B-510METR - Metallurgical Microscope

Advanced routine laboratory microscope with IOS W-PLAN MET objectives and metallurgical attachment with the exclusive **X-LED³** lighting source for both transmitted and incident illumination. The NCG (no cover glass) objectives are especially designed for microscopy use without a cover slip ideal for metallographic samples and other opaque specimens.

-  22
- 
- 
- 
- 
- 
- 
- 
- 
- 
- 

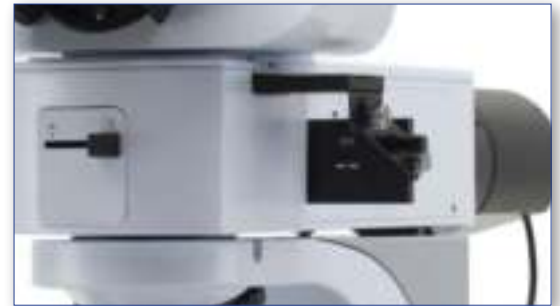
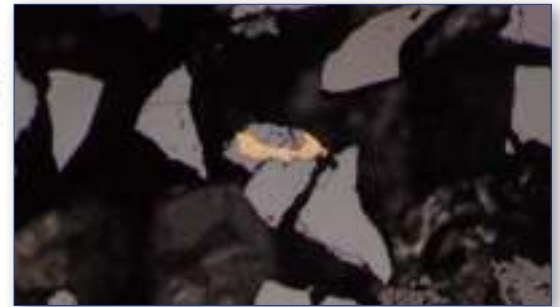

Part	Description
Observation mode:	Brightfield on transmitted light. Brightfield, simple polarized light, oblique illumination on incident light.
Epi-illumination and polarizing filters:	X-LED ⁸ with white 8 W LED (6.300 K) with brightness control. With aperture and field diaphragms, and oblique illumination system. With polarizer and analyzer.
Head:	Trinocular (fixed 50/50), 30° inclined, 360° rotating.
Interpupillary distance:	Adjustable between 50 and 75 mm.
Dioptric adjustment:	On the left eyepiece tube.
Eyepieces:	WF10x/22 mm, high eye-point and with rubber cups.
Nosepiece:	Quintuple revolving nosepiece, rotation on ball bearings.

Part	Description
Objectives (strain-free):	IOS W-PLAN MET 5x/0.12 IOS W-PLAN MET 10x/0.25 IOS W-PLAN MET 20x/0.40 IOS W-PLAN MET 50x/0.75 All with anti-fungus treatment.
Specimen stage:	Double layer rackless mechanical stage, 233x147 mm, 78x54 mm X-Y range. With tempered glass plate.
Focusing:	Coaxial coarse (adjustable tension) and fine focusing mechanism with limit stop to prevent the contact between objective and specimen.
Condenser:	Swing-out N.A. 0.2/0.9, with iris diaphragm, focusable and centerable.
Transmitted illumination (Full Koehler type):	X-LED ³ with white 3.6 W LED (6.300 K) with brightness control. Multi-plug 100-240Vac/6Vdc external power supply.

B-1000METBF - Brightfield Metallurgical Microscope

The modular OPTIKA B-1000METBF offers superior quality **brightfield incident light**, helping you working in a comfortable way during extended periods of use and performing reliable, accurate and rapid diagnosis benefiting from modularity, which gives the chance to create customized configurations tailored on customer needs. Versatile, robust, durable and sturdy, B-1000 offers premium quality optics, the state-of-the-art, exclusive **X-LED[®]** (8 W) transmitted illumination (Koehler system). The incident light relies on an incredibly bright 18 W LED illumination, designed by OPTIKA. B-1000 gives multiple options as manual or motorized configuration.



B-1000METBF - Configuration Chart

Build the microscope that suites your needs by choosing among the components



* Code M-1156 must be added only **once** for any motorized configuration

OPTIKA B-1000METDK - Darkfield Metallurgical Microscope

The modular OPTIKA B-1000METDK offers superior quality **brightfield and darkfield incident light**, helping you working in a comfortable way during extended periods of use and performing reliable, accurate and rapid diagnosis benefiting from modularity, which gives the chance to create customized configurations tailored on customer needs. Versatile, robust, durable and sturdy, B-1000 offers premium quality optics, the state-of-the-art, exclusive **X-LED[®]** (8 W) transmitted illumination (Koehler system). The incident light relies on an incredibly bright 18 W LED illumination, designed by OPTIKA. B-1000 gives multiple options as manual or motorized configuration.



B-1000METDK - Configuration Chart

Build the microscope that suites your needs by choosing among the components

M-781
PL10x/22 eyepiece, high eyepoint,
with micrometric scale (10mm/100um)
& rubber cup (retractable)



M-1001
PL10x/22 eyepieces (pair),
high eyepoint, with rubber cup
(retractable)



M-1003
PL15x/16 eyepieces (pair),
high eyepoint



M-1011
Trinocular head, three positions
(100/0, 50/50, 0/100)



M-1012
Binocular ERGO head



M-1039MD
Metallurgical attachment 18 W LED
(Built-in MET nosepiece with 6-positions)



M-1021MD
Main body with focus system
and X-LED8 illumination, for
brightfield/darkfield metallurgical B-1000



M-1021MD+M-1156*+M-1149
Main body with motorized focus system
and X-LED8 illumination, for
brightfield/darkfield metallurgical B-1000



M-1022MD
Main body with focus system
(incident light only), for
brightfield/darkfield metallurgical B-1000



M-1022MD+M-1156*+M-1149
Main body with motorized focus system
(incident light only), for
brightfield/darkfield metallurgical B-1000



IOS LWD W-PLAN MET



M-1099 2.5x

IOS LWD U-PLAN MET

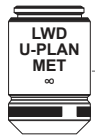

M-1100 5x
M-1101 10x
M-1102 20x
M-1103 50x
M-1104 100x

IOS LWD U-PLAN F MET



M-1171 5x
M-1172 10x
M-1173 20x
M-1174 50x
M-1175 100x

IOS LWD U-PLAN MET BD



M-1094 5x
M-1095 10x
M-1096 20x
M-1097 50x
M-1098 100x

IOS LWD U-PLAN F MET BD



M-1180 5x
M-1181 10x
M-1182 20x
M-1183 50x
M-1184 100x

M-1148
Mechanical stage with glass,
for metallurgical model



M-1147+M-1156*
Motorized mechanical stage



M-1154
0.70 N.A. swing-out MET condenser



* Code M-1156 must be added only **once** for any motorized configuration

IM-300METLD- Metallurgical Microscope

LED routine inverted microscope with IOS LWD U-PLAN MET objectives for material science and metallographic applications, combining a sturdy yet compact structure with dedicated components required in this field, like the NCG (no cover glass) objectives working without cover slide ideal for metallographic samples and other opaque specimens. A particularly simple and ingenious optical design allows stable alignments and smooth and accurate movements. This model is equipped with an 18W LED lighting system.

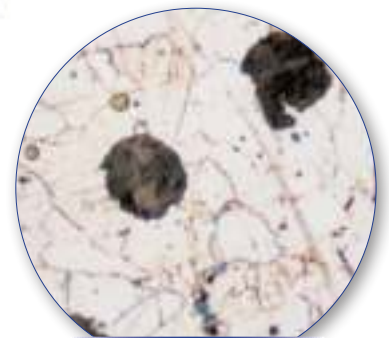

CAST IRON
BRIGHTFIELD



CAST IRON
POLARIZED LIGHT

IM-300METLD - Specifications



Part	Description
Observation mode:	Brightfield, simple polarized light.
Epi-illumination and polarizing filters:	LED 18 W with brightness control. With centrable aperture and field diaphragms. With polarizer and 360° analyzer. Supplied with blue (LBD) filter.
Head:	Trinocular (2-position 100/0, 50/50), 45° inclined.
Interpupillary distance:	Adjustable between 50 and 75 mm.
Diopter adjustment:	On the left eyepiece tube.
Eyepieces:	WF10x/22 mm, high eye-point and with rubber cups.
Nosepiece:	Quintuple revolving nosepiece, rotation on ball bearings.

Part	Description
Objectives:	IOS LWD U-PLAN MET 5x/0.15 IOS LWD U-PLAN MET 10x/0.30 IOS LWD U-PLAN MET 20x/0.45 IOS LWD U-PLAN MET 50x/0.55 All with anti-fungus treatment.
Specimen stage:	Fixed stage, 250x160 mm, with round metal stage insert.
Focusing:	Coaxial coarse (adjustable tension) and fine focusing mechanism.



IM-5MET - Metallurgical Microscope

Industrial and materials science inverted microscope especially designed for opaque specimens (including metals microstructure investigation and studies such as grain size, grain boundaries, phases, transformation, inclusions, and non-metals, as well as sample preparation and treatment) in metallography labs. Freely configurable lenses according to customer's preferences, FN 24 high eyepoint, infinity corrected optical system, coaxial focusing, mechanical stage, and epi-illumination attachment powered by halogen 12 V/100 W with brightness control. Sturdy and incredibly reliable, it is equipped with all the main controls in ergonomic position and with long lasting, efficient LED illumination to provide over 20 years of use.

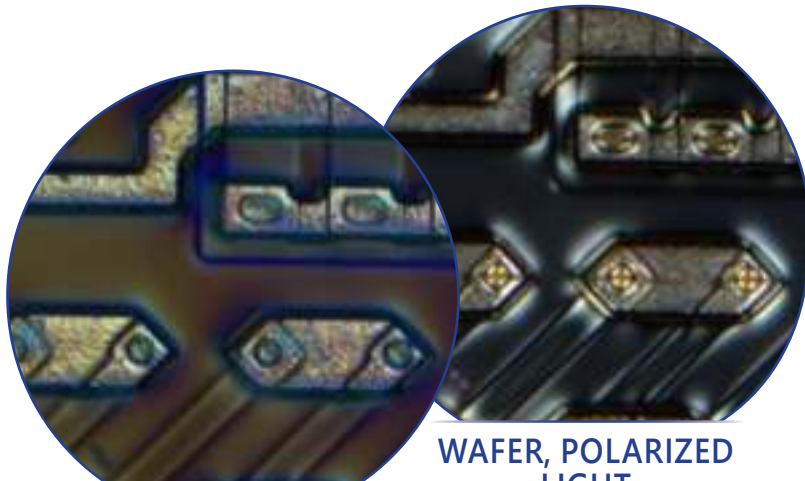

WAFER, DIC

WAFER, POLARIZED LIGHT



IM-5MET - Specifications



Part	Description
Head:	Trinocular (split ratio: 100/0, 50/50), 45° inclined.
Interpupillary distance:	Adjustable between 50 and 75 mm.
Dioptric adjustment:	Both eyepieces.
Eyepieces:	WF10x/24 mm, high eyepoint, secured by screw and with retractable rubber cups.
Epi-illumination & filters:	Halogen 12 V/100 W with brightness control. With field and aperture diaphragms, polarizer and analyzer filters.
Nosepiece:	Quintuple ball bearings revolving nosepiece, reversed.
Objectives:	Selectable according to customer's preferences. All with anti-fungus treatment.
Specimen stage:	Mechanical stage, 240x250 mm.
Focusing:	Coaxial coarse and fine focusing mechanism with limit stop to prevent the contact between objective and specimen. Adjustable tension of coarse focusing knob.

IM-5MET is freely configurable in terms of objectives, by choosing among:

 Included Optional

MET Infinity-corrected Plan-Achromatic, Long Working Distance objectives, field flatness up to F.N. 25:		
M-1100	IOS LWD U-PLAN MET objective 5x/0.15	<input type="checkbox"/>
M-1101	IOS LWD U-PLAN MET objective 10x/0.30	<input type="checkbox"/>
M-1102	IOS LWD U-PLAN MET objective 20x/0.45	<input type="checkbox"/>
M-1103	IOS LWD U-PLAN MET objective 50x/0.55	<input type="checkbox"/>
M-1104	IOS LWD U-PLAN MET objective 100x/0.80 (dry)	<input type="checkbox"/>

MET Infinity-corrected Semi-Apochromatic, Long Working Distance objectives, field flatness up to F.N. 25:		
M-1171	IOS LWD U-PLAN F MET objective 5x/0.15	<input type="checkbox"/>
M-1172	IOS LWD U-PLAN F MET objective 10x/0.30	<input type="checkbox"/>
M-1173	IOS LWD U-PLAN F MET objective 20x/0.50	<input type="checkbox"/>
M-1174	IOS LWD U-PLAN F MET objective 50x/0.80	<input type="checkbox"/>
M-1175	IOS LWD U-PLAN F MET objective 100x/0.90 (dry)	<input type="checkbox"/>

MET Infinity-corrected Plan-Achromatic, Long Working Distance objectives, for brightfield and darkfield, field flatness up to F.N. 25:		
M-1094	IOS LWD U-PLAN MET BD objective 5x/0.15	<input type="checkbox"/>
M-1095	IOS LWD U-PLAN MET BD objective 10x/0.30	<input type="checkbox"/>
M-1096	IOS LWD U-PLAN MET BD objective 20x/0.45	<input type="checkbox"/>
M-1097	IOS LWD U-PLAN MET BD objective 50x/0.55	<input type="checkbox"/>
M-1098	IOS LWD U-PLAN MET BD objective 100x/0.80 (dry)	<input type="checkbox"/>

MET Infinity-corrected Semi-Apochromatic, Long Working Distance objectives, for brightfield and darkfield, field flatness up to F.N. 25:		
M-1180	IOS LWD U-PLAN F MET BD objective 5x/0.15	<input type="checkbox"/>
M-1181	IOS LWD U-PLAN F MET BD objective 10x/0.30	<input type="checkbox"/>
M-1182	IOS LWD U-PLAN F MET BD objective 20x/0.50	<input type="checkbox"/>
M-1183	IOS LWD U-PLAN F MET BD objective 50x/0.80	<input type="checkbox"/>
M-1184	IOS LWD U-PLAN F MET BD objective 100x/0.90 (dry)	<input type="checkbox"/>

v 7.5 - OPTIKA reserves the right to make corrections, modifications, enhancements, improvements and other changes to its products at any time without notice.

Headquarters and Manufacturing Facilities

OPTIKA® S.r.l. Via Rigla, 30 - 24010 Ponteranica (BG) - ITALY - Tel.: +39 035.571.392 - info@optikamicroscopes.com

Optika Sales branches

OPTIKA® Spain spain@optikamicroscopes.com
OPTIKA® China china@optikamicroscopes.com
OPTIKA® India india@optikamicroscopes.com

OPTIKA® North America namerica@optikamicroscopes.com
OPTIKA® Central America camerica@optikamicroscopes.com
OPTIKA® Africa africa@optikamicroscopes.com

OPTIKA[®]
M I C R O S C O P E S
I T A L Y

IS SERIES



Inspection Video Microscopes

3 IS-01 - Overview

OPTIKA **IS-01** is a compact, all-in-one video microscope with **integrated HDMI camera and built-in software**.

Ideal for achieving up to 50X magnifications and performing measurements.

It's recommended when repeatability is required thanks to the click-stop mechanism at different magnifications steps.

With **60 frames** per second at full resolution and **1080 HD** image quality, you can see, on a plugged HDMI monitor, the same as what you see through the microscope eyepieces.



Integrated HDMI camera and built-in software



Click stop mechanism
Zoom
0.7x to 5x

LED Ring illumination
integrated system



Wireless mouse included

IS-01SMD - Overview

OPTIKA **IS-01SMD** is a compact, all-in-one video microscope with **integrated HDMI camera and built-in software**.

Ideal for achieving high magnifications and performing measurements.

It's recommended when repeatability is required thanks to the click-stop mechanism at different magnifications steps.

With **60 frames** per second at full resolution and **1080 HD** image quality, you can see, on a plugged HDMI monitor, the same as what you see through the microscope eyepieces. **The 3D rotational angle view attachment and the 7x to 50x zoom of IS-01SMD provide an unparalleled real-time 3D view ideal for PCB and Medical Devices inspection that is simple to use and remarkable in image quality.**

Long working distance allows soldering rework and assembly by watching LCD screen. The Built-in camera is fitted with USB2.0 slots for storing image and video without any computer using a USB flash disk. Thanks to the measurement software, it is possible to perform dimensional measurements on screen.



Integrated HDMI camera and built-in software



Click stop mechanism
Zoom
0.7x to 5x



LED Ring illumination
integrated system



3D Attachment with rotational angle
view



Wireless mouse included

IS-01/IS-01SMD - Built-it Software Overview

Main camera control panel

The camera control panel is divided into two tabs: 'Control' and 'Measurement'. Under the 'Control' tab, there are several sections:

- Exposure:** Sliders for Brightness, Gain, and Shutter, all set to 0. Buttons for 'AE' and 'MF' are present.
- Color:** Sliders for Red, Green, and Blue, all set to 0. Buttons for 'AWB' and 'MWB' are present.
- Function:** Sliders for Contrast, Sharp, Saturati, and Ezoom, all set to 0.
- Photo Path:** A dropdown menu showing 'sdcard/img' and 'Jpe'.
- Naming:** Radio buttons for 'Auto' (selected) and 'Custom'.
- Save graphic:** Radio buttons for 'yes' and 'no'.
- Other options:** 'Flip', 'Mirro', 'HDR: 0', '50/60', and 'B&W'.
- Version:** 2.3.7

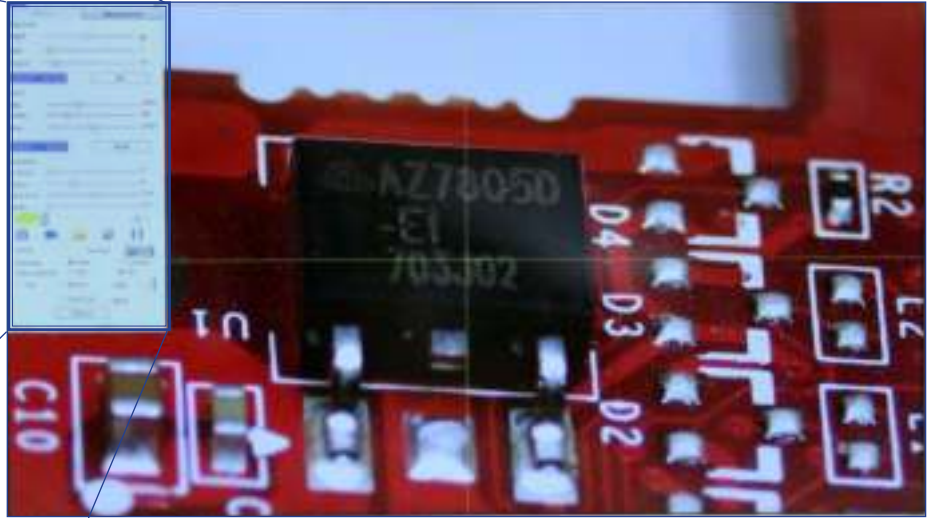

The measurement control panel is divided into two tabs: 'Control' and 'Measurement'. Under the 'Measurement' tab, there are several sections:

- Assist Tools:** A green plus icon and a minus icon.
- Main Tool:** A grid of icons for various measurement tools: a pencil, a line, a square, a circle, a triangle, a rectangle, a circle with a dot, a circle with a cross, a circle with a plus, and a circle with a minus.
- Calibration:** A dropdown menu for 'Calibrate' set to 'default'.
- Scan Da:** A text input field.
- Custom Template:** A dropdown menu for 'Name' set to 'default'.
- List Show:** A button labeled 'Export Data'.
- Table:** A table with three columns: 'ID', 'Item', and 'Result'.

Main measurement control panel

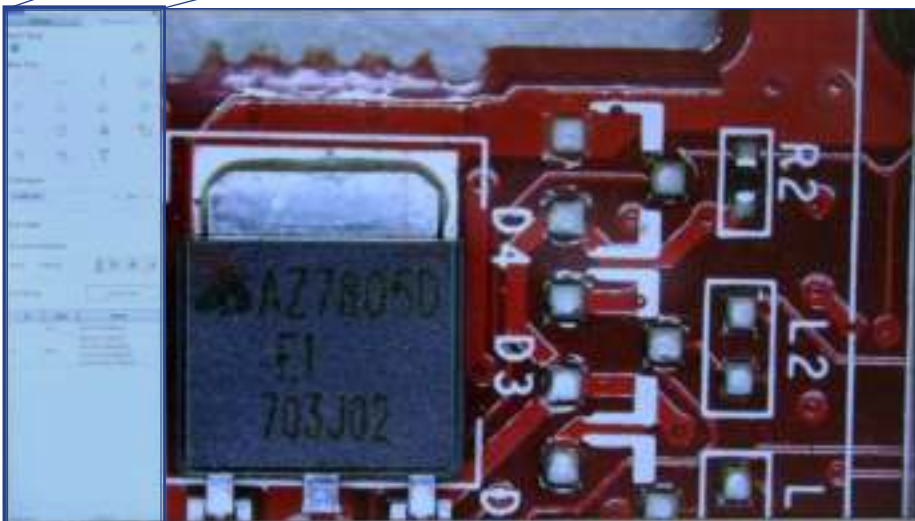

IS-01SMD - Straight/3D view quick switching

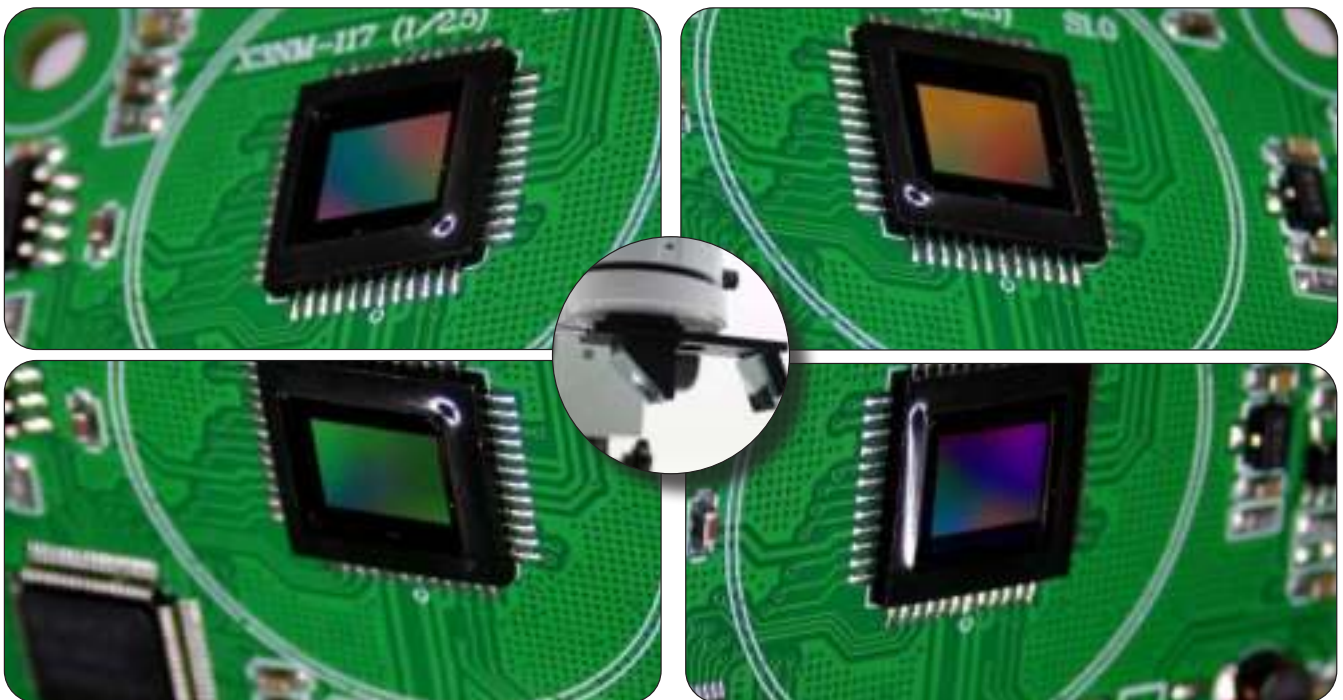

Captures of samples obtained by rotating the 3D attachment of the IS-01SMD model (optional on the IS-01 model)

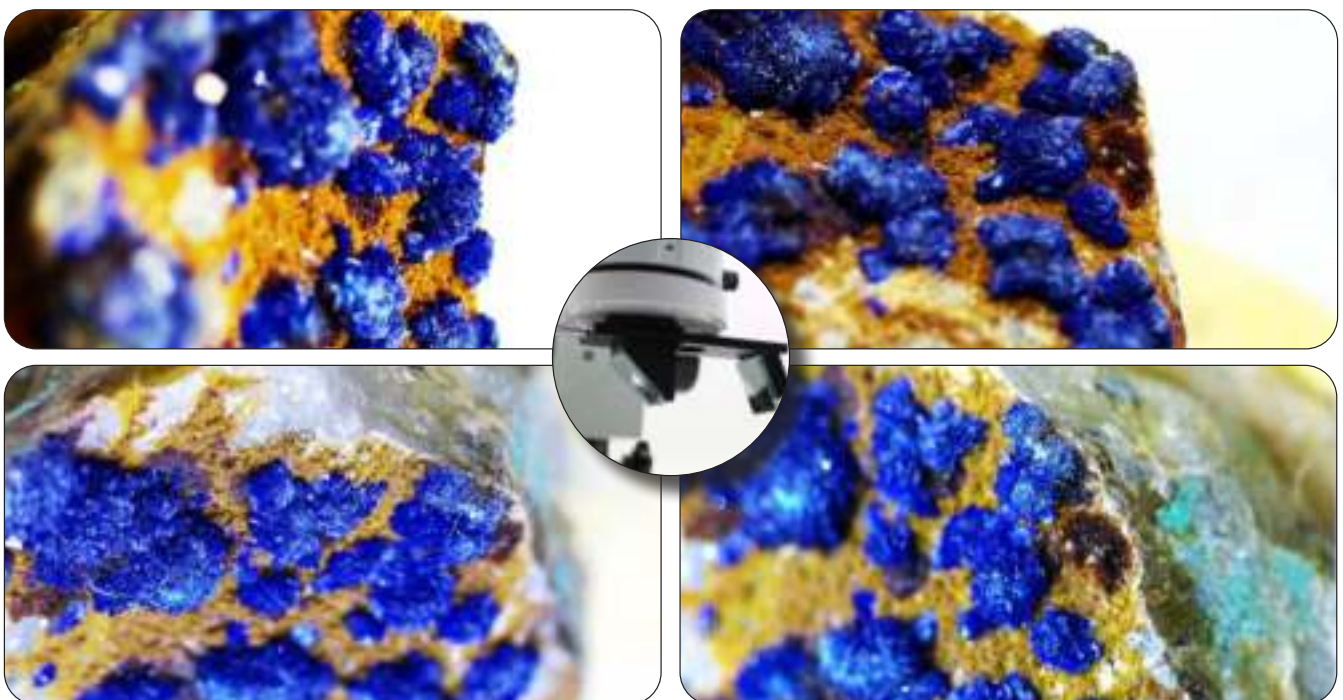

IS-01 - Straight View Zoom Factor

Straight View 0.7X

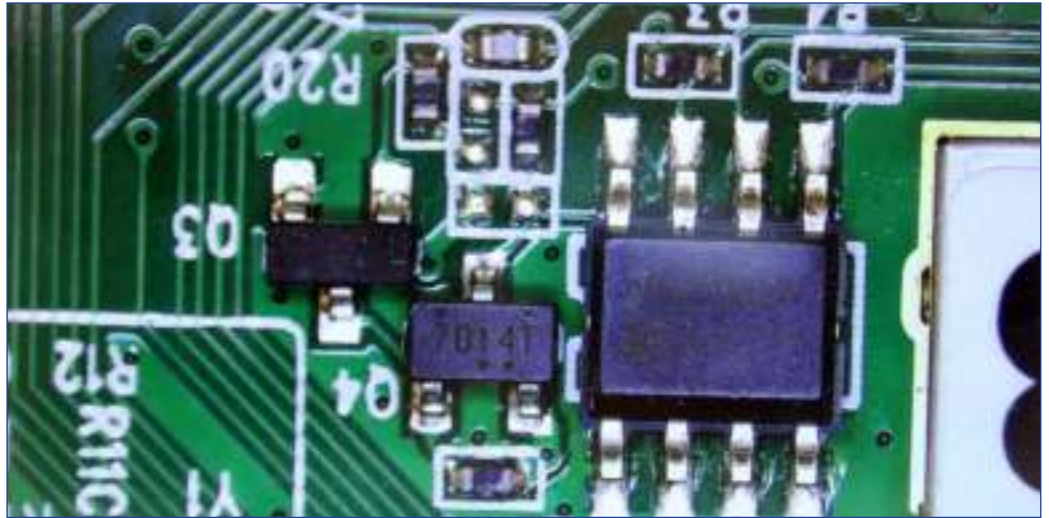

Straight View 2X

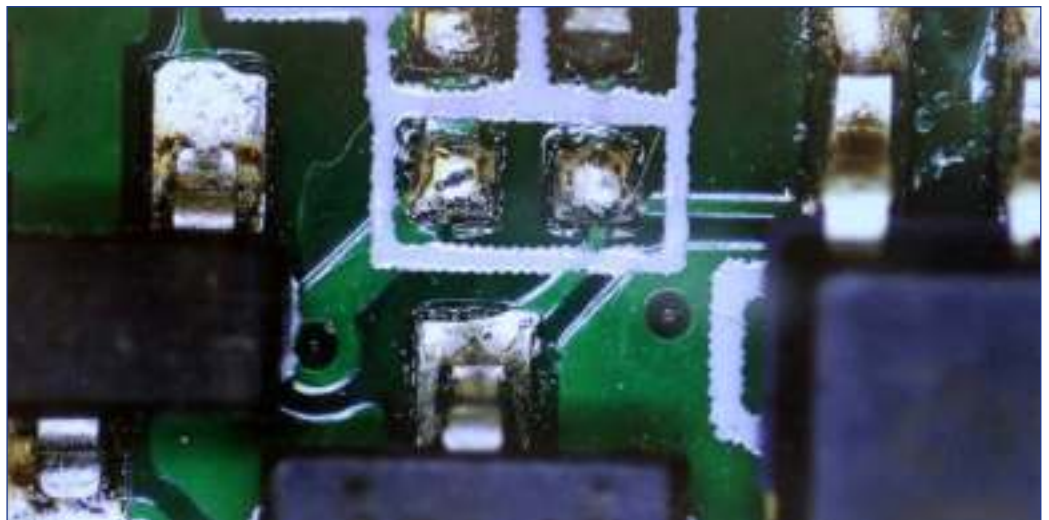

Straight View 5X

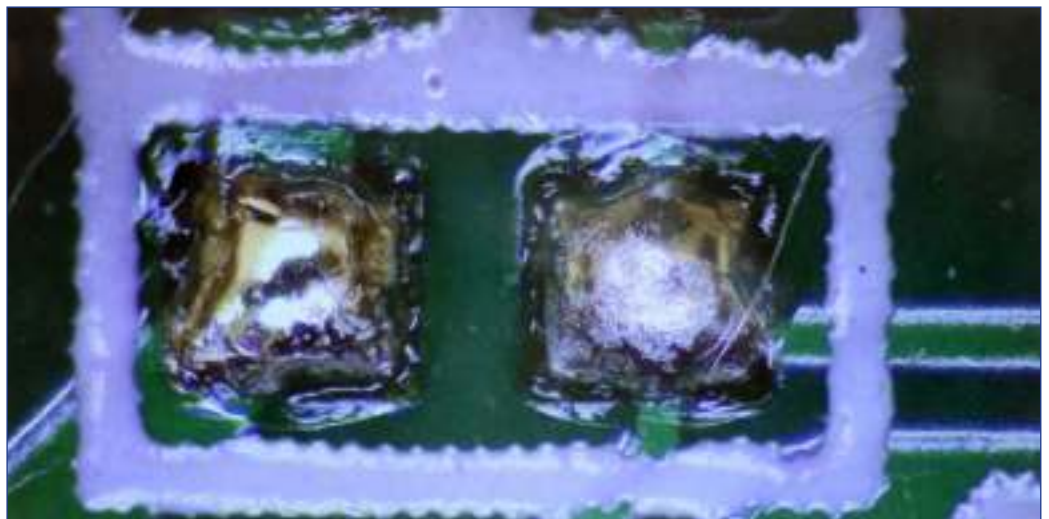

IS-01/IS-01SMD - Technical Specifications

IS-01/IS-01SMD Main Body

Observation Method	
Brightfield	Yes
Head	
Construction material	Plastic mold / Aluminum gears
Objective	
Optical system	160 mm
Anti-fungus treatment	Yes
Objective Type	Achromatic
Zoom type	Parfocal achromatic
Working distance (mm)	110
Standard magnifications	0.7x-5x
Zoom ratio	7.14
Zoom click stops	At 0.7x, 1x, 1.5x, 2x, 2.5x, 3x, 4x, 5x
Focusing System	
Type	Coarse
Coarse total travel (mm)	50
Adjustable tension	Yes
Head holder internal diameter (mm)	76
Head	
Type	Pillar
Pillar diameter (mm)	32

Incident Illumination	
Type	LED
Light source power (W)	1
Illuminance (lux)	60000
Brightness control	Manual
Lifetime (hours)	> 65000
Temperature (K)	6300
Max. required power (W)	3
Power Supply for Illumination	
Type	External
Microscope connector	Jack, 2.1 mm
Power plug type	Multi-plug (EU, UK, US)
Input voltage	110/240 Vac, 50/60 Hz
Output voltage	12 Vdc
Additional Information	
Maximum sample height (mm):	150
Product Dimensions	
Total height (mm)	510
Total width (mm)	320
Total depth (mm)	260
Weight	4.3 kg

IS-01/IS-01SMD Digital Head

Resolution (MP)	2
Sensor type	CMOS
Sensor size	1/2.8"
Sensor aspect ratio	16/9
Full image size	1920x1080
Pixel size (µm)	2.9x2.9
Frame rate	60 fps (1920x1080)

S/N ratio (dB)	>50
Dynamic range (dB)	>50
Sensitivity (V/lux*s @550nm)	0.4
Exposure time (s)	0.02 - 1/10000
USB type	2.0
Software	built-in

IS-01SMD 3D Attachment

Swing-out	Yes
360° Rotatable	Yes



IS-4K2 - Overview

Advanced inspection system suitable for intensive use, ideal for video inspection in quality control of electronics, mechanics, and other industrial applications.

IS-4K2 includes the **real-time full HD auto-focus camera** with **relevant zooming capabilities** (optical zoom is 1x...18x).

Crystal clear 4K live view is shown through a large HD monitor, with incredibly fast connection (30 fps). Its angle of view is **fully adjustable** and it enables **instant focus** in less than 1 sec. with no need to constantly adjust lens position. In addition, the working distance goes to infinity, making it the **recommended solution to inspect multi-layered objects**.

All functions are controlled directly from the screen via a wireless mouse. Images and videos can be saved on the SD card and easily transferred on any device. The system is completed by the SZ-STLX **boom stand** with a **special joint to enable any rotation** (transversal and longitudinal): the longitudinal movement is through the sliding of the horizontal rail (lockable); whilst also the overall height is both adjustable and lockable.



IS-4K2 - Technical Specifications



HDMI MONITOR

Type	LCD screen 360° rotating, freely inclinable for ergonomic vision
Size	15.6"
Power supply	5V / 4A
CAMERA	
HDMI camera resolution (MP)	8
Camera resolution (n° of pixels: W x H)	3840x2160
HDMI signal output	Yes
WiFi signal output	Yes
Sensor size	1/2.8"
Sensor technology	CMOS
Sensor type	SONY STARVIS
Optical zoom	1x-18x
Rolling shutter	Yes
Autofocus	Yes
Image format	16/9
Pixel size (mm)	1.45x1.45
Frame rate full resolution (fps)	30@3840x2160
Camera power	12V / 3A
Dimensions (mm)	80 x 80 x 116
Weight (Kg)	0,68

STAND

Type	Coarse simple overhanging
Coarse total travel (mm)	50
Adjustable tension	Yes
Head holder internal diameter (mm)	76
Pillar diameter (mm)	32
Maximum sample height (mm)	270 (from bench)
Total height (mm)	430
Base height (mm)	58
Base width (mm)	210
Base depth (mm)	255
Horizontal arm (mm)	790
Product weight (kg)	16.3

ACCESSORIES

Accessories Included:	LED ringlight, HDMI cable (0,3m), Wireless Mouse, SD card and WiFi Adapter.
------------------------------	---

On-board controls and cross grid

No need to constantly re-adjust the lens focus

1/2.8" CMOS 8MP camera with powerful 1x-18x

Sensor's main features are the **high sensitivity** and **incredible color fidelity**: save money (no need of external illuminators or ring lights)

Variable working distance from 160 to 250mm.

By using a standard W.D. of 160-255 mm the camera can be calibrated and used for linear measurement regardless the zoom factor used. The system automatically "knows" the current zoom factor and performs the correct

Sliding horizontal rail for longitudinal positioning; adjustable longitudinal limit; adjustable and lockable height

High-performance boom stand with **special joint for customized camera positioning**

Wireless mouse and SD card are included



IS-4K3 - Overview

Advanced inspection system suitable for intensive use, ideal for video inspection in quality control of electronics, mechanics, and other industrial applications.

IS-4K3 includes the **real-time full HD auto-focus camera** with **relevant zooming capabilities** (optical zoom is 1x...18x).

Crystal clear 4K live view is shown through a large HD monitor, with **incredibly fast connection** (30 fps). Its angle of view is **fully adjustable** and it enables **instant focus** in less than 1 sec. with no need to constantly adjust lens position. In addition, the working distance goes to infinity, making it the **recommended solution to inspect multi-layered objects**.

All functions are controlled directly from the screen via a wireless mouse.

Images and videos can be saved on the SD card and easily transferred on any device.

The system is completed by the **table clamping SZ-STL5 highly versatile flexible arm stand**, 360° rotating, ideal for high and large samples and on every bench thanks to its compact footprint, saving valuable space on the bench.



Reduce inspection time with real-time focus from any angle



IS-4K3 - Technical Specifications

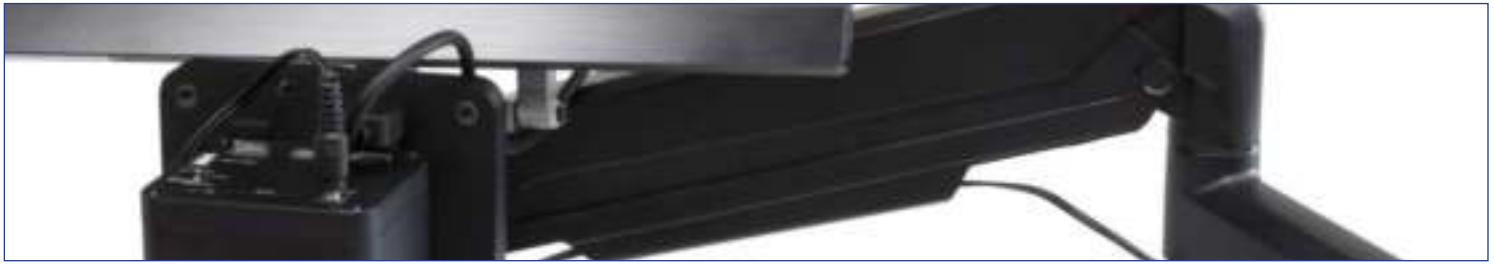

HDMI MONITOR

Type	LCD screen 360° rotating, freely inclinable for ergonomic vision
Size	15.6"
Power supply	5V / 4A
CAMERA	
HDMI camera resolution (MP)	8
Camera resolution (n° of pixels: W x H)	3840x2160
HDMI signal output	Yes
WiFi signal output	Yes
Sensor size	1/2.8"
Sensor technology	CMOS
Sensor type	SONY STARVIS
Optical zoom	1x-18x
Rolling shutter	Yes
Autofocus	Yes
Image format	16/9
Pixel size (mm)	1.45x1.45
Frame rate full resolution (fps)	30@3840x2160
Camera power	12V / 3A
Dimensions (mm)	80 x 80 x 116
Weight (Kg)	0,68

STAND

Type	Coarse, Pantograph, with table
Coarse total travel (mm)	50
Adjustable tension	Yes
Head holder internal diameter (mm)	76
Pillar diameter (mm)	35
Total height (mm)	327
Total width (mm)	300
Total depth (mm)	800
Horizontal arm (mm)	737
Product Weight (kg)	5.1
ACCESSORIES	
Accessories Included:	LED ringlight, HDMI cable (0,3m), Wireless Mouse, SD card and WiFi Adapter.

No need to constantly re-adjust the lens focus



1/2.8" CMOS 8MP camera with **powerful 1x-18x optical zoom**

On-board controls and cross grid

Sensor's main features are the **high sensitivity** and **incredible color fidelity**: save money (no need of external illuminators or ring lights)

Small footprint to save valuable space on the bench; table

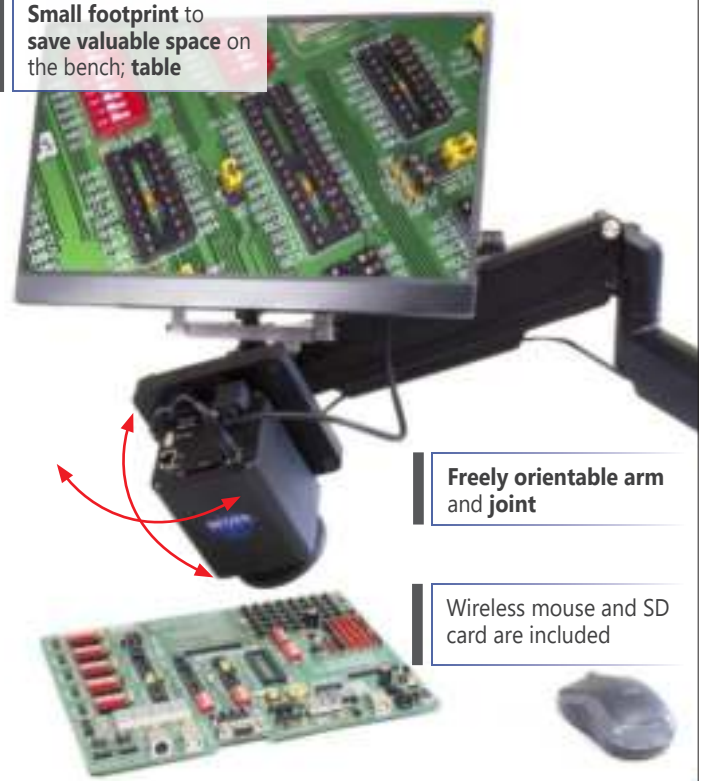

Freely orientable arm and joint

Wireless mouse and SD card are included

v 7.5 - OPTIKA reserves the right to make corrections, modifications, enhancements, improvements and other changes to its products at any time without notice.

Headquarters and Manufacturing Facilities

OPTIKA® S.r.l. Via Rigla, 30 - 24010 Ponteranica (BG) - ITALY - Tel.: +39 035.571.392 - info@optikamicroscopes.com

Optika Sales branches

OPTIKA® Spain spain@optikamicroscopes.com
OPTIKA® China china@optikamicroscopes.com
OPTIKA® India india@optikamicroscopes.com

OPTIKA® North America north@optikamicroscopes.com
OPTIKA® Central America central@optikamicroscopes.com
OPTIKA® Africa africa@optikamicroscopes.com



CAMERAS & DIGITAL Solutions

Cameras for Microscopy & Digital Scanner

4 CAMERAS & DIGITAL Solutions

The most flexible way to create a digital microscope is to combine a digital camera to a standard microscope. You can then move the camera on different microscopes and different cameras on any microscope for an incredible versatility. Moreover, since microscope camera technology is improving so rapidly, it is easy to replace a camera as new ones are released.

OPTIKA offers an impressive amount of microscope camera, all of which are easy-to-use, affordable and professionally selected for excellent color resolution and rapid transmission. Downloadable, free of charge software is always available to enable the latest updates.

Applications include standard image capture and documentation for education, schools, home as well as professional image analysis for laboratories and industrial inspections, including very advanced solutions for critical applications like low light fluorescence imaging and material science applications.

Entry-Level Microscope Cameras

page 357

Smart & Affordable Solutions – Not Only For Schools & Education...

A wide range of affordable solutions with diversified live resolution for clear and crisp images to be combined via USB, HDMI or Wi-Fi.

Professional Microscope Cameras

page 381

Comprehensive Range, Remarkable Performance

An impressive offering compatible with any microscope brand to ensure the highest performance available for routine applications in professional environments, with USB, HDMI, 4K, Wi-Fi connections.

















High Microscope Cameras

page 407

High Sensitivity Fluorescence Cameras

In order to detect the often low levels of fluorescence emitted by specimens, cameras used in fluorescence microscopy must have particular features, including high sensitivity and low noise, in order to capture as many photons as possible. These cameras are typically equipped with CCD sensor, although nowadays there is always a larger selection of scientific-grade CMOS.

Icons

	Multi-Plug low voltage power supply		USB 2.0 input (mouse)		HDMI output
	Li-Ion Rechargeable battery		USB 2.0 output		SD/MicroSD slot
	CCD sensor		USB 3.0 output		Wi-Fi
	CMOS sensor		Tablet screen size		BlueTooth
	Camera resolution		Software included		Mouse included
	Cooling system		ETHERNET output		

Entry-Level Microscope Cameras



Smart & Affordable Solutions Not Only For Schools & Education...

A wide range of affordable solutions with diversified live resolution for clear and crisp images to be combined via USB, HDMI or Wi-Fi ensuring smooth and productive teaching experiences on PC, tablets, projectors and other devices.

These models can also be used for basic requirements in laboratories and industries.

Compatible with any microscope brand, thanks to the projection lens and rings (included in most of the cases).

4 Entry-Level Microscope Cameras



E like Essential

Simply the most essential eyepiece camera (C-E2). That's it!

C-E2 E2 eyepiece camera, 2 MP CMOS, USB2.0

B like Basic - C-B Series

The cost-effective OPTIKA C-B cameras are generally recommended for basic/general applications in education and home use. With C-B+ models, faster transmission speed is achieved through USB3.0 connection, being ideal especially on moving specimens.

- C-B1** B1 camera, 1.3 MP CMOS, USB2.0
- C-B3A** B3 camera, 3.1 MP CMOS, USB2.0
- C-B5** B5 camera, 5.1 MP CMOS, USB2.0
- C-B16** B16 camera, 16 MP CMOS, USB2.0
- C-B10+** B10+ camera, 10 MP CMOS, USB3.0
- C-B18+** B18+ camera, 18 MP CMOS, USB3.0



Entry-Level Microscope Cameras

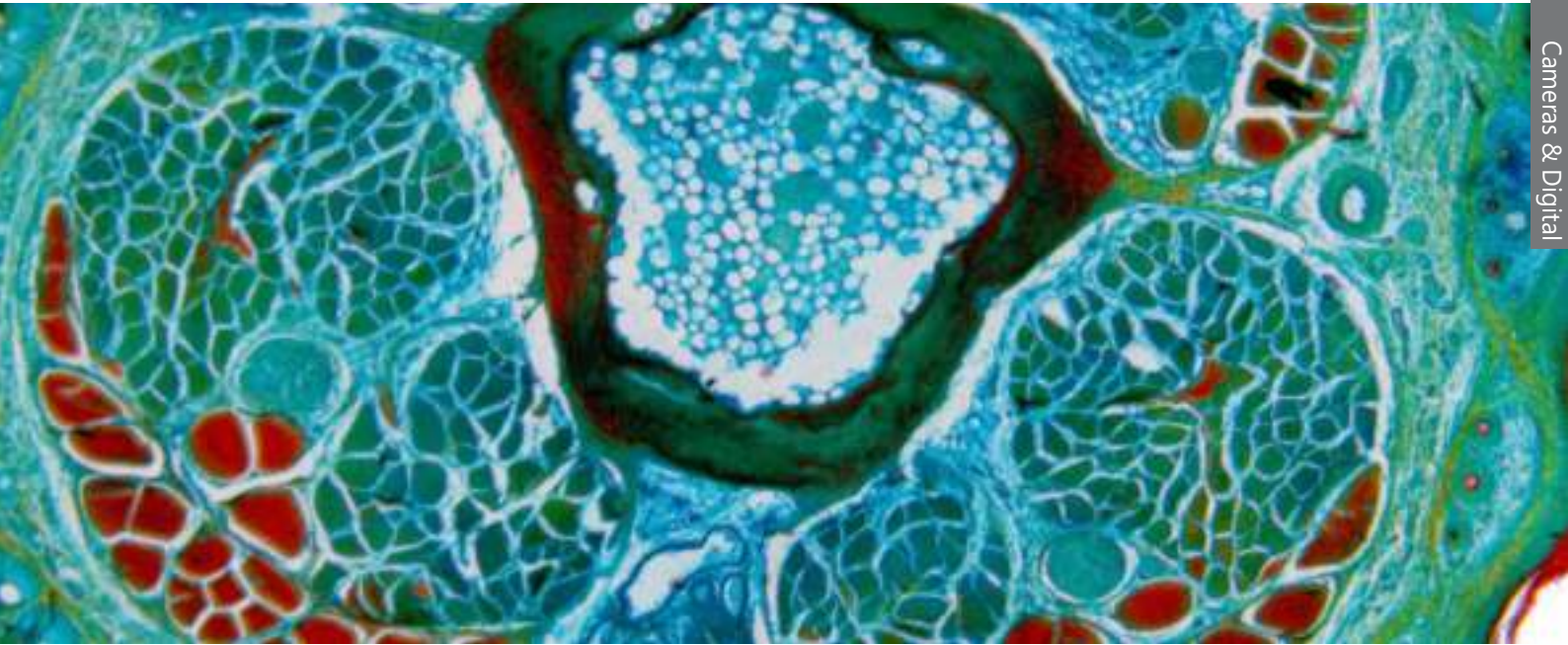

TB like Tablet - TB Series

The combination of OPTIKA C-B cameras with Windows tablet PC for a completely new, revolutionary experience. Not a simple tablet but a real PC with large touch screen for smooth and responsive control, representing an extremely comfortable solution for open discussions.

TB-3W Windows tablet PC with B3 camera, 3.1 MP CMOS, USB2.0, EU

TB-5W Windows tablet PC with B5 camera, 5.1 MP CMOS, USB2.0, EU

HE like HDMI Essential - C-HB & C-HBSC

Recommended for its easy operation, no software installation is required with image captured on SD card. SC version includes a 11.5" Full HD screen for an all-in-one solution, with tilting features and saving space on the bench.

C-HB HB Camera, 1080p, 2 MP CMOS, HDMI, multi-plug

C-HBSC HB Camera, 1080p, 2 MP CMOS, HDMI, with screen, multi-plug

WiFi Cameras - WiFi Series

The most flexible and versatile camera on the market!

New frontiers are opened thanks to its rechargeable batteries (C-WFR), allowing the camera to be moved from one microscope to another, whilst transferring the live view on any device (using Windows, Android or IOS).

C-WF WF camera, 1 MP CMOS, Wi-Fi, multi-plug

C-WFR WFR rechargeable camera, 1 MP CMOS, Wi-Fi, multi-plug



C-E2

2.0
MP

CMOS

USB-OUT



Simply the most essential, user-friendly and handy eyepiece camera for low budget, with 2 MP resolution, CMOS sensor and USB2.0 connection.

Ready to use on any microscope with direct eyepiece tube connection, thanks to the rings included. Connectable also on trinocular tube.

Downloadable, free of charge software (Windows, Mac OS or Linux) is always available to enable the latest updates.

Model:

C-E2: E2 eyepiece camera, 2 MP CMOS, USB2.0

C-E2

Digital camera resolution	2 MP
Analog camera resolution	NO
Signal output	USB 2.0
Audio Signal	NO
Sensor Size	1\3.2"
Sensor technology	CMOS
Image format	4\3
Full Image size	1600 x 1200
Frame rate full resolution	5 fps (1600x1200) / 7,5 fps (1280x1024) / 20fps (800x600) / 22fps (640x480)
Max Exposure time	Auto
ON board Memory	NO
External Memory Card	NO
External camera power	PC USB
White Balance	Auto
Gain Control	Auto
Back light control	Auto
Exposure control	Auto
C-Mount connection	NO
CS-Mount connection	NO
Arm length	-
8mm objective	NO

Accessories included:

C-E2: 30 mm / 30.5 mm ring adapters, 1.8 m USB cable.



C-E2



- » Simple operation, driver-free
- » Universal connection to any microscope brand
- » Direct eyepiece & trinocular port connection
- » Crisp 2 MP images
- » High frame rate
- » Reliable color fidelity
- » Rings included
- » USB cable included
- » Downloadable, free of charge software
- » OPTIKA ProView & LiteView for Windows
- » OPTIKA LiteView for Mac OS or Linux



④ C-B Series

1.3/18
MP

CMOS



USB-OUT



C-B

C-B+

Cost-effective, user-friendly cameras with several resolutions (from 1.3 up to 18 MP), CMOS sensor and USB2.0 or USB3.0 connection, recommended for basic/general applications in education and home use especially on moving specimens. Ready to use on any microscope with direct eyepiece tube connection, thanks to the C-mount projection lens and rings included. Connectable also to all the trinocular tube of different brands using the C-mount projection lens included or additional focusable C-Mount adapter. Downloadable, free of charge software (Windows, Mac OS or Linux) is always available to enable the latest updates.

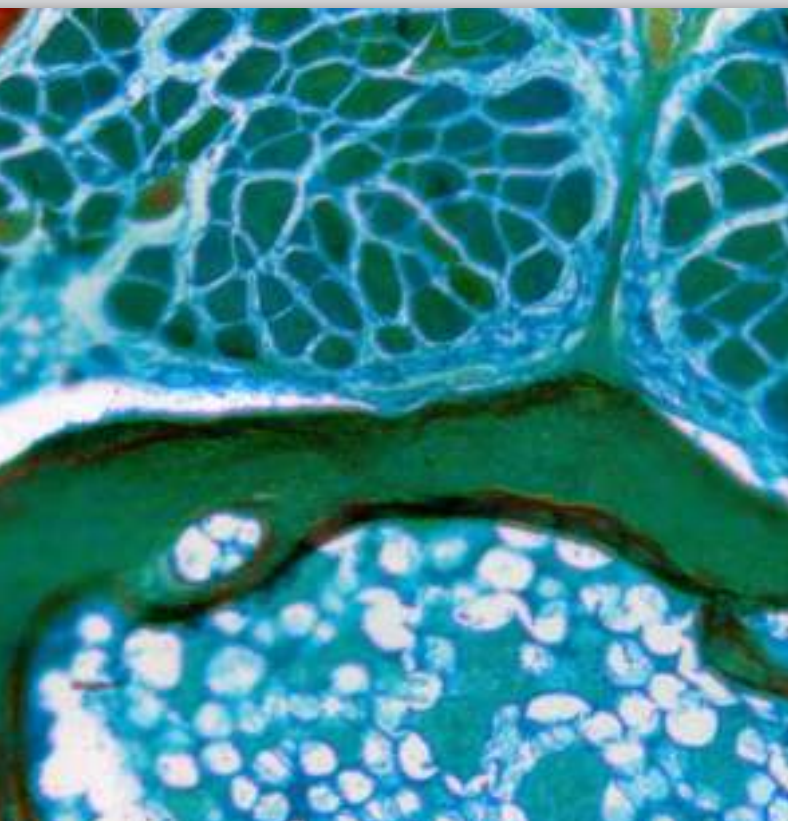

C-B Series

- » Simple operation, driver-free
- » Universal connection to any microscope brand
- » Direct eyepiece & trinocular port connection
- » Crisp 1.3 MP crisp images
- » Reliable color fidelity
- » C-Mount projection lens and rings included
- » USB cable and calibration slide included
- » Downloadable, free of charge software
- » OPTIKA ProView & LiteView for Windows
- » OPTIKA LiteView for Mac OS or Linux



4 C-B Series

C-B Models:

- C-B1:** B1 camera, 1.3 MP CMOS, USB2.0
- C-B3:** B3 camera, 3.1 MP CMOS, USB2.0
- C-B5:** B5 camera, 5.1 MP CMOS, USB2.0
- C-B16:** B16 camera, 16 MP CMOS, USB2.0

C-B+ Models:

- C-B10+:** B10+ camera, 10 MP CMOS, USB3.0
- C-B18+:** B18+ camera, 18 MP CMOS, USB3.0



C-B Series - Specifications

	C-B1	C-B3A	C-B5
Digital camera resolution	1.3 MP (1280 x 1024)	3.1 MP (2048 x 1536)	5.1 MP (2592 x 1944)
Signal output	USB 2.0	USB 2.0	USB 2.0
Sensor Size	1/3"	1/2.8"	1/2.5"
Sensor technology	CMOS	CMOS	CMOS
Sensor type	Aptina CMOS	Aptina CMOS	Aptina CMOS
Image format	5/4	4/3	4/3
Pixel size	3.6 x 3.6 μm	2.5 x 2.5 μm	2.2 x 2.2 μm
Frame rate full resolution	15 fps (1280 x 1024)	10.5 fps (2048x1536)	7 fps (2592 x 1944)
Frame rate other resolutions	50 fps (320 x 256)	15 fps (1920x1080)	27 fps (1280 x 960); 90fps (640 x 480)
Sensitivity	1 V/lux-second	600mV at 1/30sec	0.53 V/lux-second
Signal / noise ratio	44 dB	40.5 dB	40.5 dB
Dynamic range	74 dB	66.5 dB	66.5 dB
ADC conversion	8 Bit	8 Bit	8 Bit
Color Depth	1 Bit; 4 Bit; 8 Bit; 24 Bit	1 Bit ; 4 Bit; 8 Bit; 24 Bit	1 Bit; 4 Bit; 8 Bit; 24 Bit
Exposure Time	0.14 msec - 2 sec	0.244 msec - 2 sec	0.294 msec - 2 sec
Binning	1x1; 2x2; 4x4	1x1; 2x2; 3x3	1x1; 2x2; 4x4
IR filter	380-650 nm (IR-cut filter)	380-650 nm (IR-cut filter)	380-650 nm (IR-cut filter)
Camera power	PC USB	PC USB	PC USB
C-mount	YES	YES	YES

C-B Series



C-B Contents:

- USB camera
- USB 2.0 cable
- 30 & 30.5 mm rings
- C-mount projection lens
- Micrometric slide



C-B+ Contents:

- USB camera
- USB 3.0 cable
- 30 & 30.5 mm rings
- C-mount projection lens
- Micrometric slide



C-B16	C-B10+	C-B18+
16 MP (4632 x 3488)	10 MP (3584 x 2748)	18 MP (4912 x 3684)
USB 2.0	USB 3.0	USB 3.0
1/2.3"	1/2.3"	1/2.3"
CMOS	CMOS	CMOS
Aptina CMOS	Aptina CMOS	Aptina CMOS
4/3	4/3	4/3
1.335 x 1.335 μm	1.67 x 1.67 μm	1.25 x 1.25 μm
2 fps (4632 x 3488)	7.2 fps (3584 x 2746)	5.6 fps (4912 x 3684)
8 fps (2320 x 1740); 11 fps (1536 x 1160)	24.5 fps (1792 x 1372);	18.1 fps (2456 x 1842); 32.2 fps (1228 x 922)
0.31 V/lux-second	0.31 V/lux-second	0.62 V/lux-second
-	34 dB	36.3 dB
65 dB	65.2 dB	65.8 dB
8 Bit	8 Bit - 12 Bit	8 Bit - 12 Bit
1 Bit; 4 Bit; 8 Bit; 24 Bit	1 Bit; 4 Bit; 8 Bit; 24 Bit	1 Bit; 4 Bit; 8 Bit; 24 Bit
0.2 msec - 2 sec	0.4 msec - 2 sec	0.1 msec - 2 sec
1x1; 2x2; 3x3	1x1; 2x2; 4x4	1x1; 2x2; 4x4
380-650 nm (IR-cut filter)	380-650 nm (IR-cut filter)	380-650 nm (IR-cut filter)
PC USB	PC USB	PC USB
YES	YES	YES

TB Series



TB-3W

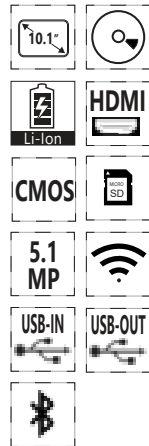

TB-5W

Exclusive, powerful Windows tablet PC combined to a CMOS sensor cameras with USB2.0 connection, recommended for discussion groups and educational purposes thanks to the easy operation, space-saving features and unparalleled comfort. The unique holding solution for open discussion is 360° rotating and tilting for any adjustment, whilst the large touch screen provides fast, responsive and smooth control.

At any time, the tablet PC can be easily detached to be used as a laptop.

Non-stop operation is granted by the simultaneous camera and power connection for long-term use and class/lesson alternation.

Connectable also to all the trinocular tube of different brands using the projection lens included or additional focusable C-Mount adapter. Downloadable, free of charge software is always available to enable the latest updates.

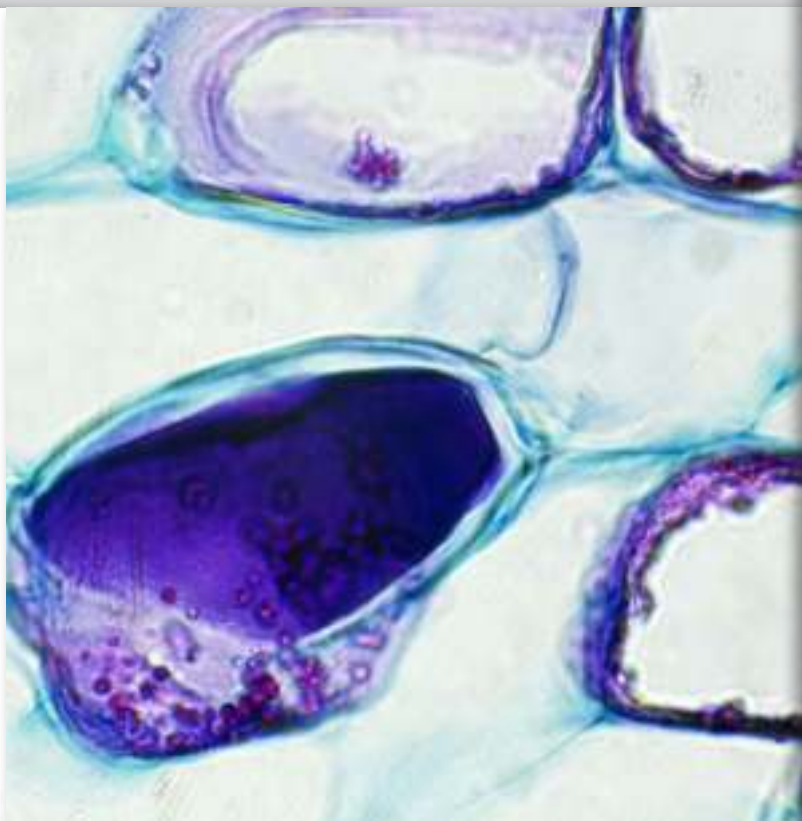

TB Series

- » External digital camera connected to Windows tablet PC
- » Large touch screen with fast, responsive and smooth control
- » Easily detachable, can be used as a laptop
- » A 2-in-1 solution that you can use like a PC, being Windows-based
- » Simultaneous camera and power connection for long-term operation
- » Powerful Intel processor ensuring top performance and speed
- » High-resolution, vivid color graphic display
- » Crisp 3.1 or 5.1 MP images
- » High frame rate
- » Reliable color fidelity
- » C-mount connection (direct or via dedicated adapter, on any microscope)
- » C-mount projection lens and calibration slide included
- » Downloadable, free of charge software
- » OPTIKA ProView for Windows



4 TB Series

Tablet Models:

TB-3W: Windows tablet PC with B3 camera, 3.1 MP CMOS, USB2.0, EU

TB-5W: Windows tablet PC with B5 camera, 5.1 MP CMOS, USB2.0, EU



OPTIONAL

TB Series - Specifications

CAMERA TECHNICAL SPECIFICATIONS	TB-3W	TB-5W
Digital camera resolution	3.1 MP (2048 x 1536)	5.1 MP (2592 x 1944)
Signal output	USB 2.0	USB 2.0
Sensor Size	1/2"	1/2.5"
Sensor technology	CMOS	CMOS
Sensor type	Aptina CMOS	Aptina CMOS
Image format	4/3	4/3
Pixel size	3.2 x 3.2 μm	2.2 x 2.2 μm
Frame rate full resolution	12 fps (2048 x 1536)	7 fps (2592 x 1944)
Frame rate other resolutions	32 fps (1024 x 768); 45 fps (680 x 510)	27 fps (1280 x 960); 90fps (640 x 480)
Sensitivity	1 V/lux-second	0.53 V/lux-second
Signal / noise ratio	43 dB	40.5 dB
Dynamic range	61 dB	66.5 dB
ADC conversion	8 Bit	8 Bit
Color Depth	1 Bit ; 4 Bit; 8 Bit; 24 Bit	1 Bit; 4 Bit; 8 Bit; 24 Bit
Exposure Time	0.244 msec - 2 sec	0.294 msec - 2 sec
Binning	1x1; 2x2; 3x3	1x1; 2x2; 4x4
IR filter	380-650 nm (IR-cut filter)	380-650 nm (IR-cut filter)
Camera power	PC USB	PC USB
C-mount	YES	YES

TB Series



TB Contents:

- USB camera
- Windows tablet PC
- C-mount projection lens
- Micrometric slide
- OTG cable (micro USB-C to USB-A)
- USB cable USB-B to USB-A (0.5m)
- External power supply

TB Series - Tablet specifications

TABLET TECHNICAL SPECIFICATIONS	
Operating system	Windows 10 (64Bit)
CPU	Gemini-Lake, N4100
CPU speed	1.10 GHz
Graphic card	Intel® HD Graphics 600
RAM	Ram 6 GB LPDDR3
Display size	LED 10.1" IPS Multi Touch Screen
Display resolution	1920x1200
Storage	Hdd 128 GB
Network	WiFi (2.4G / 5G) - Bluetooth 5.0
Input ports	USB-C (1 USB2.0 for battery charge, 1 USB3.0) - Micro SD card reader
Output ports	Microphone - Headphone - Micro HDMI
Battery Type	Lithium-ion
Battery capacity	6500 mAh
Power consumption	24.05W
Power supply	12V 2A EU
Dimensions (mm)	261 x 167 X 9
Weight (Kg)	0.53
Language	Multilanguage
Weight	530 g
Tablet accessories included	OTG cable (micro USB-C to USB-A) USB cable USB-B to USB-A (0.5m)



C-HB & C-HBSC



C-HB



C-HBSC

Cost-effective, entry-level HD camera with 1080p, 2 MP resolution, CMOS sensor and HDMI connection, recommended for its easy operation, no software installation is required with image capturing on SD card.

Connection into the eyepiece tube or to the trinocular tube of any microscope brand via dedicated adapter (to be purchased separately). Wireless mouse, SD card and built-in software included.



C-HB & C-HBSC

C-HB

- » Simple operation, built-in software
- » Crisp 2 MP images
- » High frame rate
- » Reliable color fidelity
- » C-mount connection (direct or via dedicated adapter, on any microscope)
- » Mouse and SD card included



4

Cameras & Digital

C-HBSC

- » External digital camera connected to full HD monitor
- » Large screen with fast, responsive and smooth control
- » Tilttable to be adjustable in height
- » Simple operation, built-in software
- » Vivid color graphic display
- » Crisp 2 MP images
- » High frame rate
- » Reliable color fidelity
- » C-mount connection (direct or via dedicated adapter, on any microscope)
- » Mouse and SD card included

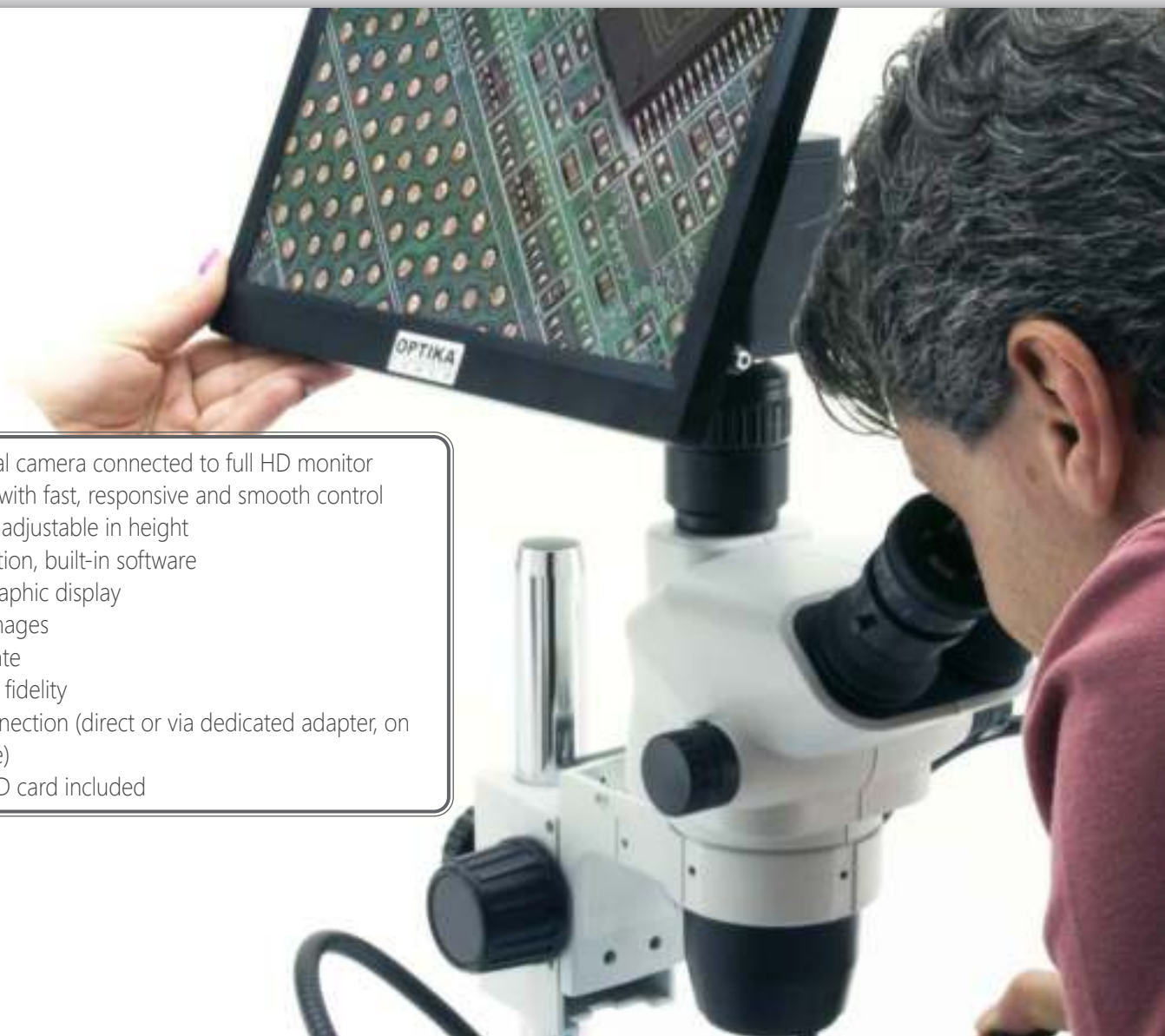

④ C-HB & C-HBSC

C-HB Models:

C-HB: HB camera, 1080p, 2 MP CMOS, HDMI, multi-plug

C-HBSC: HB camera, 1080p, 2 MP CMOS, HDMI, with screen, multi-plug



C-HB & C-HBSC - Specifications

	C-HB	C-HBSC
Video resolution (USB output)	-	-
Video resolution (HDMI output)	HD 1080p	HD 1080p
Digital camera resolution	2 MP (1280 x 720)	2 MP (1280 x 720)
Signal output	HDMI	HDMI
Sensor Size	1/2.8"	1/2.8"
Sensor technology	CMOS	CMOS
Sensor type	SONY STARVIS	SONY STARVIS
Image format	16/9	16/9
Pixel size	2.9 x 2.9 μm	2.9 x 2.9 μm
Frame rate (HDMI)	60@1920X1080	60@1920X1080
Sensitivity	1300 mV at 1/30sec	1300 mV at 1/30sec
Dark Signal	0.15mV at 1/30sec	0.15mV at 1/30sec
Exposure Time	0.01 msec - 1 sec	0.01 msec - 1 sec
Binning	1x1	1x1
IR filter	380-650 nm (IR-cut filter)	380-650 nm (IR-cut filter)
Camera power	DC 12V 1A	DC 12V 1A
C-mount	YES	YES
White balance	Auto/Manual//ROI	Auto/Manual//ROI
Live HDMI measurement	Yes	Yes
Exposure control	Auto / Manual	Auto / Manual

C-HB & C-HBSC



C-HB Contents:

- HDMI camera
- HDMI cable
- SD card
- Wireless mouse
- Multi-plug external power supply
- Calibration slide



C-HBSC Contents:

- HDMI camera
- HDMI monitor
- HDMI cable
- SD card
- Wireless mouse
- Multi-plug external power supply (2 pcs.)
- calibration slide



C-HB & C-HBSC - Monitor Specifications

MONITOR TECHNICAL SPECIFICATIONS

Size	11,5"
Power supply	12V / 2,5A
HDMI cable	150 cm



WiFi Cameras – WiFi Series

5.0
MP

CMOS

USB-OUT



C-WF



C-WRF

Cost-effective and user-friendly Wi-Fi camera with good resolution, CMOS sensor and Wi-Fi connection, recommended for basic/general applications in education and home use.

Complete cordless operation is ensured thanks to the rechargeable batteries (5 hours autonomy per single charge) (C-WRF) and direct Wi-Fi as no router is required thanks to the direct remote application for simplified use.

Ready to use on any microscope with direct eyepiece tube connection, thanks to the C-mount projection lens and rings included.

Connectable also to all the trinocular tube of different brands using the C-mount projection lens included or additional focusable C-Mount adapter.

Downloadable, free of charge software (Windows, Mac OS or Linux) is always available to enable the latest updates.



WiFi Cameras – WiFi Series



- » Simple, intuitive operation with powerful software
- » Universal connection to any microscope brand
- » Direct eyepiece & trinocular port connection
- » Wi-Fi interface
- » Direct Wi-Fi connection (no router is required)
- » Cordless use, totally independent from the mains connection (C-WFR)
- » Battery-operated to enable portable use for approx. 5 hours (C-WFR)
- » Image and video capturing function when used in Wi-Fi mode
- » Reliable colour fidelity
- » C-mount projection lens and rings included
- » USB cable for batteries recharge (C-WFR) and calibration slide included
- » Downloadable, free of charge software
- » OPTIKA ProView & LiteView for Windows
- » OPTIKA LiteView for Mac OS or Linux



4 WiFi Cameras – WiFi Series

WiFi Series model:

C-WF: WF camera, 1 MP CMOS, Wi-Fi, multi-plug

C-WFR: WFR rechargeable camera, 1 MP CMOS, Wi-Fi, multi-plug



WiFi Series - Specifications

CAMERA TECHNICAL SPECIFICATIONS	C-WF / C-WFR
Camera sensor resolution	2592x1944
Signal output	USB 2.0
Sensor Size	1/2"
Sensor technology	CMOS
Sensor type	Aptina CMOS
Image format	4/3
Pixel size	2.2 x 2.2 μm
Frame rate full resolution	10 fps (1280x720)
Frame rate other resolutions	10 fps (1280x720) (WiFi)
Sensitivity	1 V/lux-second
Signal / noise ratio	43 dB
Dynamic range	61 dB
ADC conversion	8 Bit
Color Depth	8 Bit
Exposure Time	Auto
Binning	2x2
IR filter	380-650 nm (IR-cut filter)
Camera power	Ni-MH (AA-size) Rechargeable batteries (only on C-WFR model) Multiplug 100-240Vac/6Vdc external power supply
C-mount	YES

WiFi Cameras – WiFi Series

C-WF Contents:

- Wi-Fi camera
- 30 & 30.5 mm rings
- C-mount projection lens
- Micrometric slide
- Multi-plug external power supply



C-WFR Contents:

- Wi-Fi rechargeable camera
- 30 & 30.5 mm rings
- C-mount projection lens
- Micrometric slide
- Multi-plug external power supply



4 Recommended Camera Adapters

		Upright			
		Monocular Binocular (Ø 23 mm)	Trinocular (Ø 23 mm)	Binocular (Ø 30 mm)	Trinocular
Camera model	Sensor size	Ecovision / B-60 / B-150 B-190-290 / B-380 (ALC)	B-190 / B-290 B-380 (with M-699)	B-510 / B-810 / B-1000	B-380 / B-510 B-810 / B-1000
C-B1	1/3"	Included with the camera	Included with the camera	Included with the camera	M-620
C-B3A	1/2.8"	Included with the camera	Included with the camera	Included with the camera	M-620
C-B5	1/2.5"	Included with the camera	Included with the camera	Included with the camera	M-620.1
C-B16	1/2.33"	Included with the camera	Included with the camera	Included with the camera	M-620.1
C-B10+	1/2.3"	Included with the camera	Included with the camera	Included with the camera	M-620.1
C-B18+	1/2.3"	Included with the camera	Included with the camera	Included with the camera	M-620.1
TB-3W	1/2"	-	Included with the camera	M-114 + M-113.1	M-620.1
TB-5W	1/2.5"	-	Included with the camera	M-114 + M-113.1	M-620.1
C-HB	1/2.8"	M-115	M-115	M-115 + M-113.1	M-620
C-HBSC	1/2.8"	M-115	M-115	M-115 + M-113.1	M-620
C-WF/C-WFR	1/2.5"	Included with the camera	Included with the camera	M-114 + M-113.1	M-620.1

M-114 / M-115



M-113.1 / M-113.2



M-620



M-620.1



Recommended Camera Adapters

Inverted	Stereo		
Trinocular	Binocular (Ø 30.5 mm)	Binocular (Ø 30 mm)	Trinocular
IM-3 / IM-5	SFX	SLX / SZ / SZP	SLX / SZ / SZP
M-620	Included with the camera	Included with the camera	M-620
M-620	Included with the camera	Included with the camera	M-620
M-620.1	Included with the camera	Included with the camera	M-620.1
M-620.1	Included with the camera	Included with the camera	M-620.1
M-620.1	Included with the camera	Included with the camera	M-620.1
M-620.1	Included with the camera	Included with the camera	M-620.1
M-620.1	Included with the camera	Included with the camera	M-620.1
M-620.1	Included with the camera	Included with the camera	M-620.1
M-620	M-115 + M-113.2	M-115 + M-113.1	M-620
M-620	M-115 + M-113.2	M-115 + M-113.1	M-620
M-620.1	Included with the camera	Included with the camera	M-620.1



v 7.5 - OPTIKA reserves the right to make corrections, modifications, enhancements, improvements and other changes to its products at any time without notice.

Headquarters and Manufacturing Facilities

OPTIKA® S.r.l. Via Rigla, 30 - 24010 Ponteranica (BG) - ITALY - Tel.: +39 035.571.392 - info@optikamicroscopes.com

Optika Sales branches

OPTIKA® Spain spain@optikamicroscopes.com
OPTIKA® China china@optikamicroscopes.com
OPTIKA® India india@optikamicroscopes.com

OPTIKA® North America namerica@optikamicroscopes.com
OPTIKA® Central America camerica@optikamicroscopes.com
OPTIKA® Africa africa@optikamicroscopes.com

Professional Microscope Cameras

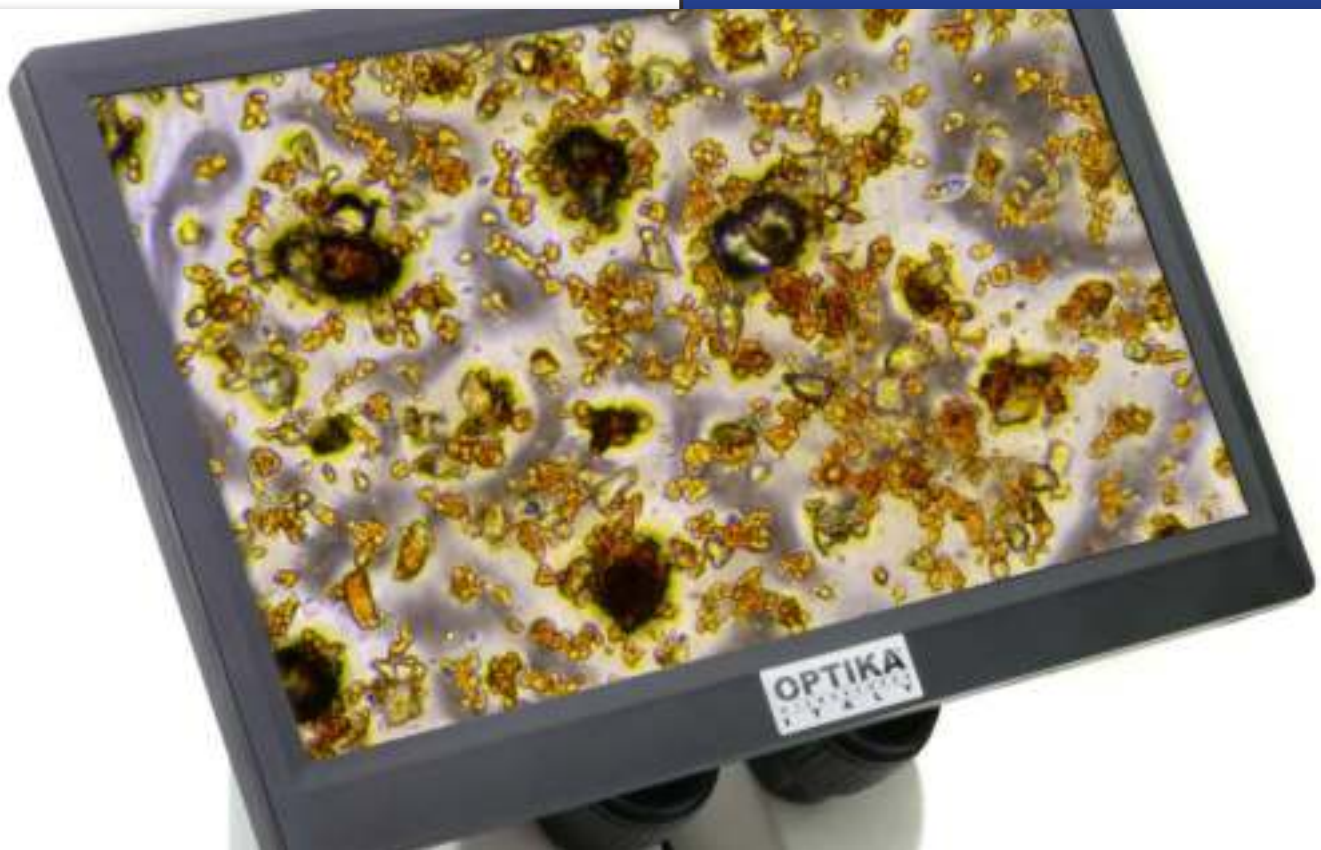

Professional Microscope Cameras Comprehensive Range, Remarkable Performance

An impressive offering compatible with any microscope brand to ensure the highest performance available for routine applications in professional environments, with USB, HDMI, 4K, Wi-Fi connections. Images and videos will be of the highest quality and rich in contrast and detail with the top-class SONY sensors, worldwide recognized, ensuring beautiful true-to-life color and delivering incredibly accurate colors just as you see them.

The compact and elegantly designed housing conceals the very latest in camera technology.

④ Professional Microscope Cameras

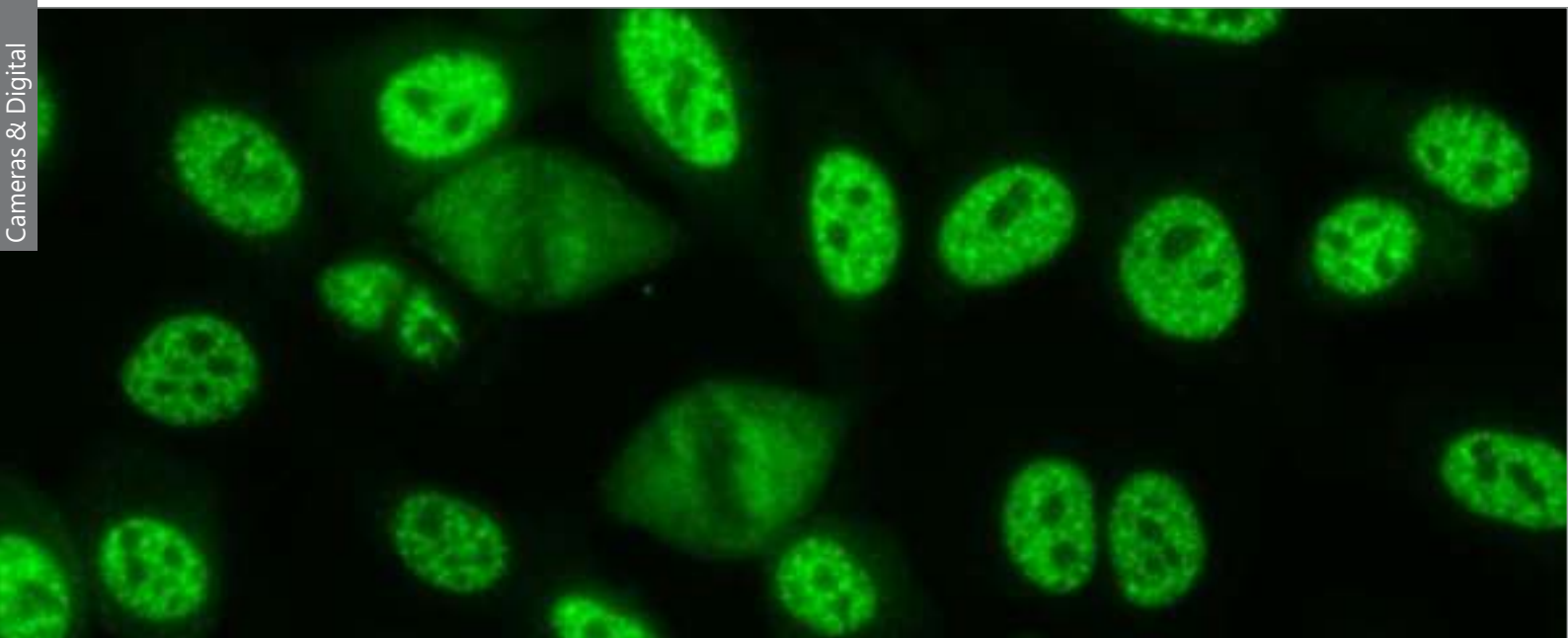

P as Professional

Recommended for professional use in laboratory and industrial field, the valuable yet affordable OPTIKA C-P cameras are equipped with top-class SONY EXMOR sensors and USB3.0 connection for premium features and faster transmission speed. Perfect for most of the brightfield, darkfield, phase contrast and metallographic applications when requiring PC/Laptop operation.

- C-P3** P3 Pro camera, 3.1 MP CMOS, USB3.0
- C-P6** P6 Pro camera, 6.3 MP CMOS, USB3.0
- C-P8** P8 Pro camera, 8.3 MP CMOS, USB3.0
- C-P20** P20 Pro camera, 20 MP CMOS, USB3.0

GS like Global Shutter

Global shutter camera are designed when particularly high-motion captures are needed, being perfect for enabling 'freeze frame' of fast changing events, exposing each and every pixel simultaneously on PC/Laptop. Superb with moving specimens in brightfield, darkfield, phase contrast and even in polarized light observations thanks to the generous dynamic range which gives a great response to light and dark at the same time.

- C-P5GS** P5GS Pro global shutter camera, 5 MP CMOS, USB3.0

WH like Wi-fi & HDMI

The most versatile cameras with endless possibilities perfect for most of the brightfield, darkfield, phase contrast and material science applications. Take benefit from the on-board imaging software to display live view directly on monitor and projector, with data storage on SD card; or download the professional imaging software for PC.

- C-WH5** WH5 camera, 1080p, 5 MP CMOS, Wi-Fi/HDMI, multi-plug
- C-WH5SC** WH5 camera, 1080p, 5 MP CMOS, Wi-Fi/HDMI, with screen, multi-plug



Professional Microscope Cameras



④ C-P Series

3.1/20
MP

CMOS



USB-OUT



Professional yet very easy to use cameras with several resolutions (from 3.1 up to 20 MP), large SONY EXMOR CMOS sensor and USB3.0 connection, recommended for general scientific or industrial purposes requiring rapid speed transmission.

The compact and elegantly designed housing conceals the very latest in camera technology.

Images will be of the highest quality and rich in contrast and detail with the top-class SONY sensors, worldwide recognized, ensuring beautiful true-to-life color and delivering incredibly accurate colors just as you see them.

Ideal to be connected to all the trinocular tube of different brands using the focusable C-Mount adapter (to be purchased separately).

Downloadable, free of charge software (Windows, Mac OS or Linux) is always available to enable the latest updates.

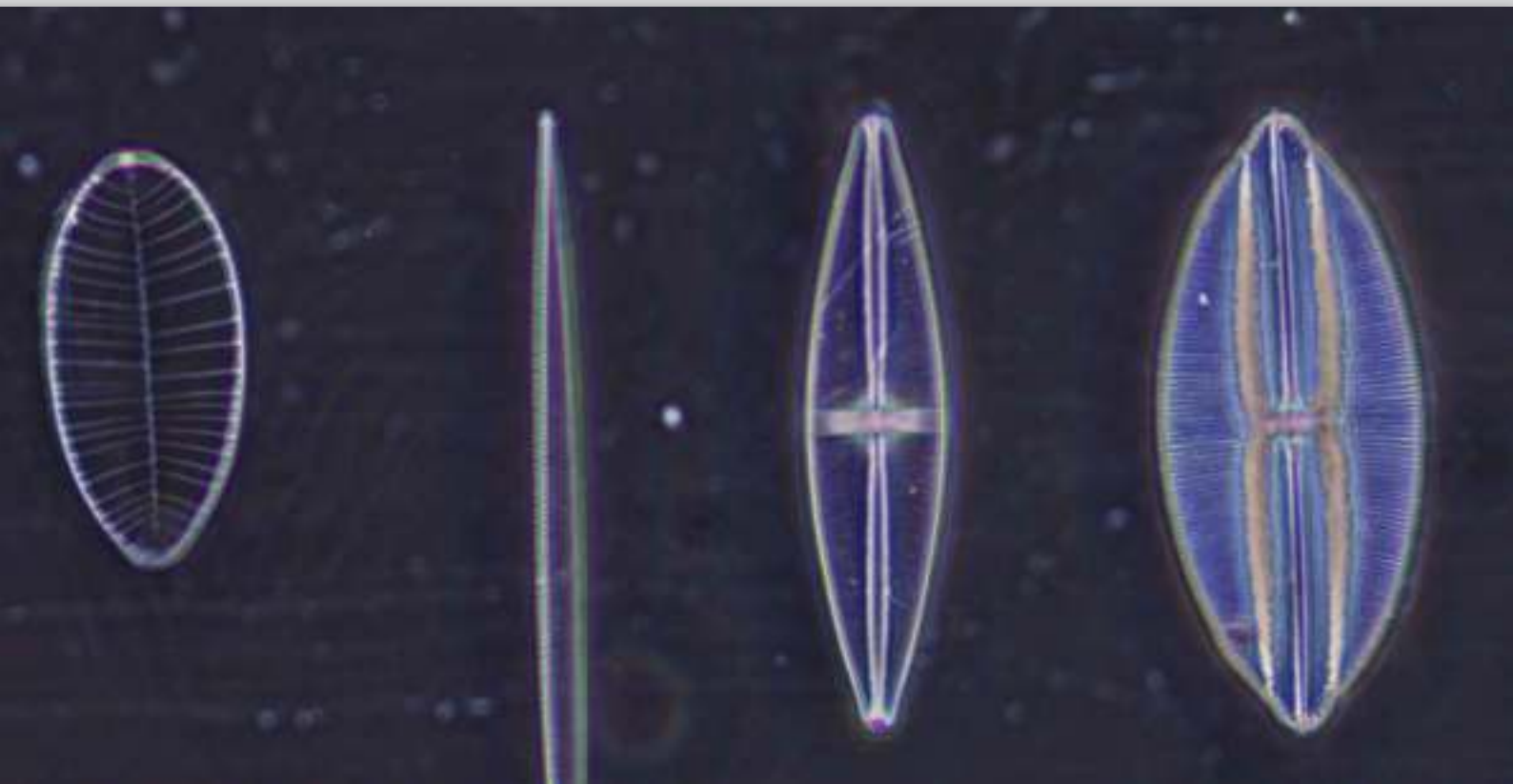

C-P Series

- » Simple operation, driver-free
- » Top-class SONY EXMOR sensor
- » Universal connection to any microscope brand
- » Crisp 3.1 to 20 MP images
- » USB3.0 for impressive high frame rate
- » Incredibly accurate colors
- » USB cable and calibration slide included
- » Downloadable, free of charge software
- » OPTIKA ProView & LiteView for Windows
- » OPTIKA LiteView for Mac OS or Linux"

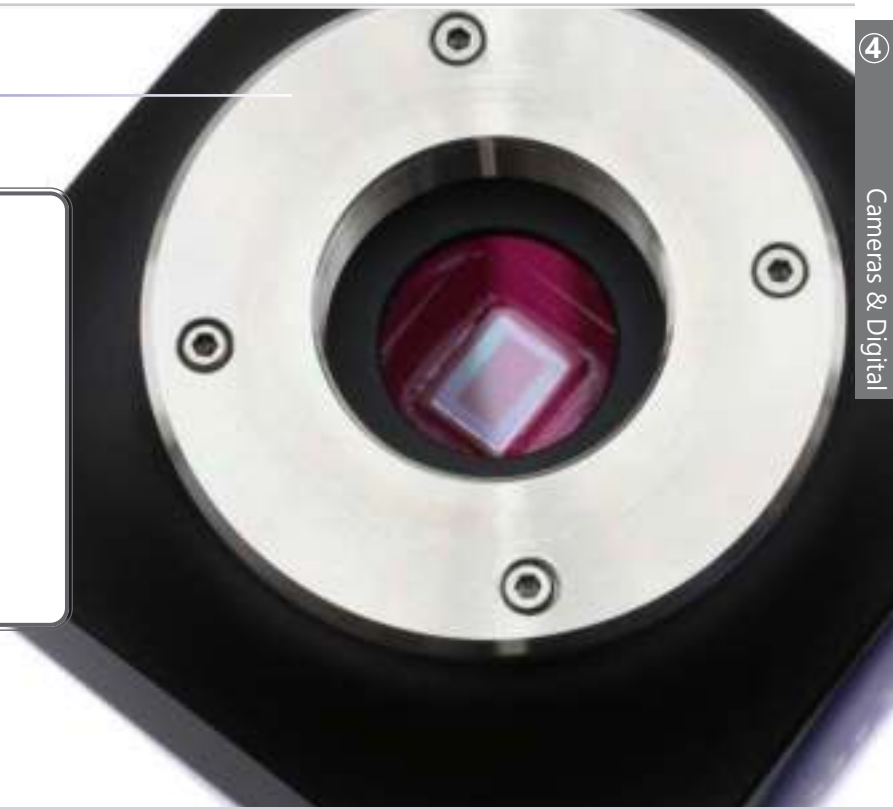

4 C-P Series

C-P Models:

- C-P3:** P3 Pro camera, 3.1 MP CMOS, USB3.0
- C-P6:** P6 Pro camera, 6.3 MP CMOS, USB3.0
- C-P6AR:** P6 Pro camera, 6.3 MP CMOS, USB3.0 (AR glass)
- C-P8:** P8 Pro camera, 8.3 MP CMOS, USB3.0
- C-P20:** P20 Pro camera, 20 MP CMOS, USB3.0



C-P Series - Specifications

	C-P3	C-P6	C-P6AR	C-P8
Digital camera resolution	3.1 MP (2048 x 1536)	6.3 MP (3072 x 2048)	6.3 MP (3072 x 2048)	8.3 MP (3840 x 2160)
Signal output	USB 3.0	USB 3.0	USB 3.0	USB 3.0
Sensor Size	1/2.8"	1/1.8"	1/1.8"	1/2.5"
Sensor technology	CMOS	CMOS	CMOS	CMOS
Sensor type	SONY EXMOR	SONY EXMOR	SONY EXMOR	SONY EXMOR
Image format	4/3	3/2	3/2	16/9
Pixel size	2.5 x 2.5 μm	2.4 x 2.4 μm	2.4 x 2.4 μm	1.62 x 1.62 μm
Frame rate full resolution	50 fps (2048 x 1536)	30 fps (3072 x 2048)	30 fps (3072 x 2048)	32 fps (3840 x 2160)
Frame rate other resolutions	50 fps (1920 x 1080)	38 fps (1536 x 1024)	38 fps (1536 x 1024)	65 fps (1920 x 1080)
G Sensitivity	600mV at 1/30s	425mV at 1/30s	425mV at 1/30s	236mV at 1/30s
Dark Signal	0.15mV at 1/30s	0.15mV at 1/30s	0.15mV at 1/30s	0.1mV at 1/30s
Dynamic range	66 dB	66.8 dB	66.8 dB	65 dB
ADC conversion	8 Bit - 12Bit	8 Bit - 12Bit	8 Bit - 12Bit	8 Bit - 12Bit
Color Depth	1 Bit; 4 Bit; 8 Bit; 24 Bit	1 Bit; 4 Bit; 8 Bit; 24 Bit	1 Bit; 4 Bit; 8 Bit; 24 Bit	1 Bit; 4 Bit; 8 Bit; 24 Bit
Exposure Time	0.1 msec - 15 sec	0.1 msec - 15 sec	0.1 msec - 15 sec	0.244 msec - 15 sec
Binning	1x1	1x1; 2x2	1x1; 2x2	1x1; 2x2
IR filter	380-650 nm (IR-cut filter)	380-650 nm (IR-cut filter)	380-1050 nm (AR glass)	380-650 nm (IR-cut filter)
Camera power	PC USB	PC USB	PC USB	PC USB
C-mount	YES	YES	YES	YES

C-P Series



C-P Contents:

- USB camera
- USB 3.0 cable
- Micrometric slide



C-P20

20 MP (5440 x 3648)

USB 3.0

1"

CMOS

SONY EXMOR

3/2

2.4 x 2.4 μm

15 fps (5440 x 3648)

50 fps (2736 x 1824); 60 fps (1824 x 1216)

462mV at 1/30s

0.21mV at 1/30s

66.3 dB

8 Bit - 12Bit

1 Bit; 4 Bit; 8 Bit; 24 Bit

0.1 msec - 15 sec

1x1; 2x2; 3x3

380-650 nm (IR-cut filter)

PC USB

YES



④ C-PGS Model

5 MP

CMOS



USB-OUT



Professional yet very easy to use cameras with several resolutions, large SONY EXMOR CMOS sensor, USB3.0 connection and Global Shutter mode. Global Shutter mode can be easily thought of as a 'Snapshot' exposure mode, perfect for capturing images of moving objects and enabling 'freeze frame' capture of fast changing events, exposing each and every pixel simultaneously. In addition, the generous dynamic range gives a great response to light and dark simultaneously, being recommended for polarizing light applications. The compact and elegantly designed housing conceals the very latest in camera technology. Images will be of the highest quality and rich in contrast and detail with the top-class SONY sensors, worldwide recognized, ensuring beautiful true-to-life color and delivering incredibly accurate colors just as you see them. Ideal to be connected to all the trinocular tube of different brands using the focusable C-Mount adapter (to be purchased separately). Downloadable, free of charge software (Windows, Mac OS or Linux) is always available to enable the latest updates.

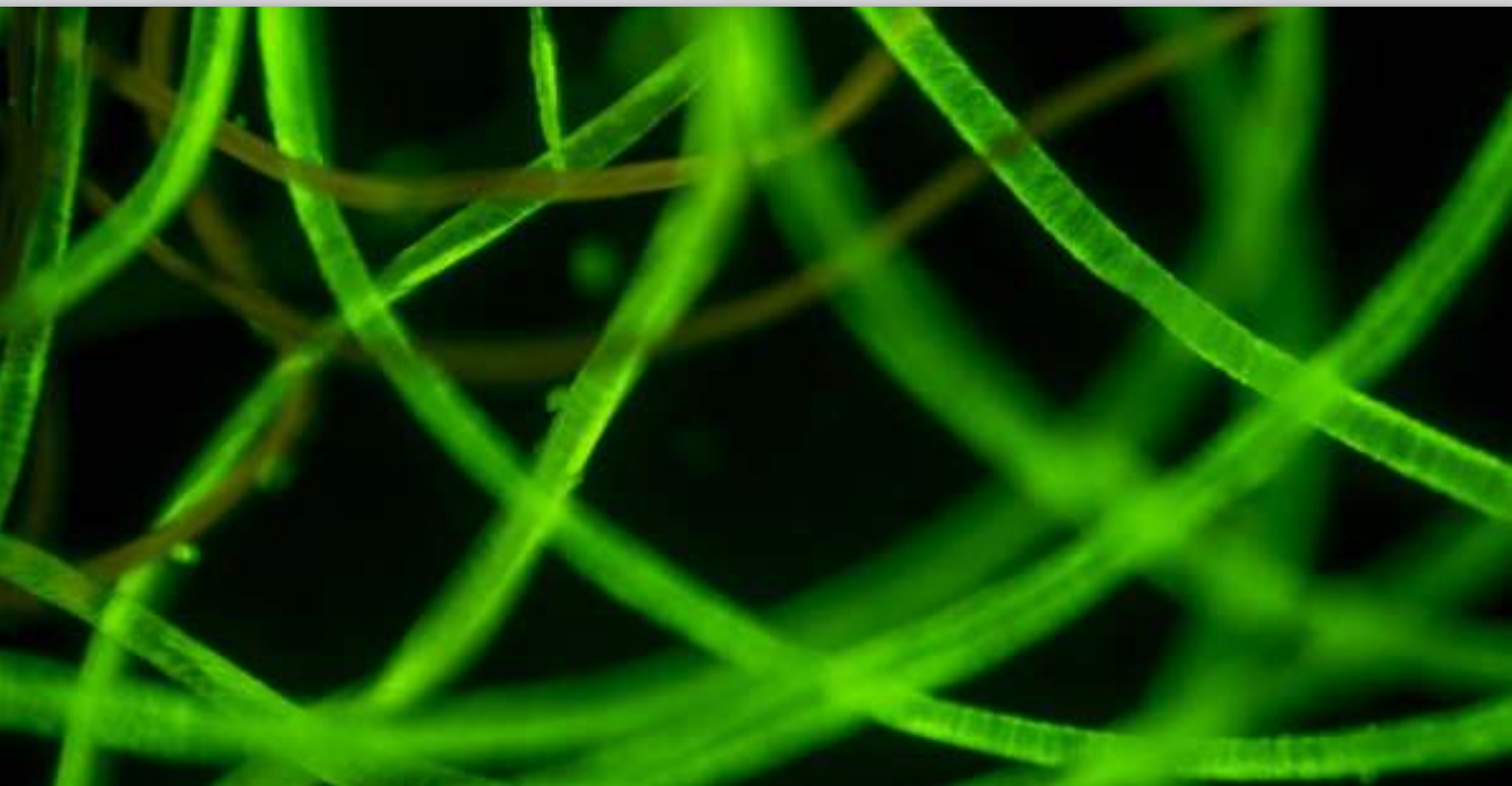

C-PGS Model

- » Simple operation, driver-free
- » Top-class SONY EXMOR sensor
- » Universal connection to any microscope brand
- » Crisp 5MP images
- » Global Shutter technology for "freeze frame" capture
- » Generous dynamic range, recommended for polarizing light
- » USB3.0 for impressive high frame rate
- » Crystal-clear images, even for very short exposures
- » Outstanding noise characteristics, even in low lighting conditions
- » Incredibly accurate colors
- » USB cable and calibration slide included
- » Downloadable, free of charge software
- » OPTIKA ProView & LiteView for Windows
- » OPTIKA LiteView for Mac OS or Linux"



4 C-PGS Model

C-PGS Model:

C-P5GS: P5GS Pro global shutter camera, 5 MP CMOS, USB3.0



C-PGS Model - Specifications

	C-P5GS
Digital camera resolution	5 MP (2448 x 2048)
Signal output	USB 3.0
Sensor Size	2/3"
Sensor technology	CMOS
Sensor type	SONY EXMOR
Image format	5/4
Pixel size	3.45 x 3.45 μ m
Frame rate full resolution	35 fps (2448 x 2048)
Frame rate other resolutions	50 fps (1224 x 1024)
G Sensitivity	1146mV at 1/30s
Dark Signal	0.15mV at 1/30s
Dynamic range	70.60 dB
ADC conversion	8 Bit - 12 Bit
Color Depth	1 Bit; 4 Bit; 8 Bit; 24 Bit
Exposure Time	0.1 msec - 15 sec
Binning	1x1;
IR filter	380-650 nm (IR-cut filter)
Camera power	PC USB
C-mount	YES

C-PGS Model

C-PGS Contents:

- USB camera
- USB 3.0 cable
- Micrometric slide



C-WH5 & C-WH5SC



C-WH5



C-WH5SC

Smart and user-friendly dual output (HDMI & Wi-Fi) camera with good resolution (up to 5 MP), high-grade SONY CMOS sensor and HDMI/Wi-Fi connection, recommended for routine operations and whenever measurements are required. No software installation is required with image and video capturing on SD card when in HDMI mode. No router or external applications are required thanks to the quick and simple camera connection. At any time, it can be connected to PC and used via the downloadable, free of charge software (Windows), which is always available to enable the latest updates. The compact and elegantly designed housing conceals the very latest in camera technology. Images will be of the highest quality and rich in contrast and detail with the top-class SONY sensors, worldwide recognized, ensuring beautiful true-to-life color and delivering incredibly accurate colors just as you see them. Ideal to be connected to all the trinocular tube of different brands using the focusable C-Mount adapter (to be purchased separately).

Connection into the eyepiece tube or to the trinocular tube of any microscope brand via dedicated adapter (to be purchased separately). Available also as an all-in-one, space saving package including a 11.5" full HD monitor with compact footprint, enabling screen adjustment to ensure correct posture and eliminate fatigue during observation connectable to trinocular tube only via dedicated adapter (to be purchased separately). Wireless mouse, SD card and built-in software included.

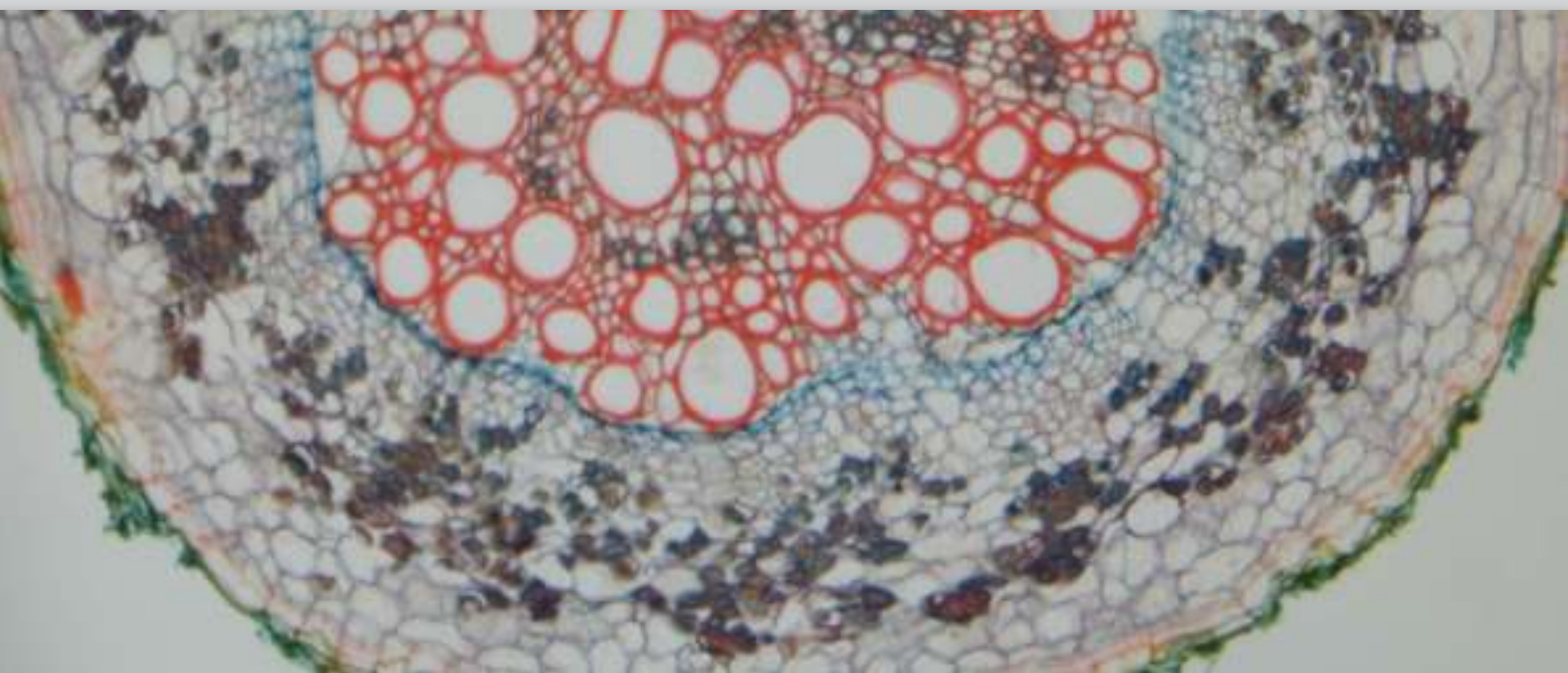

C-WH5 & C-WH5SC

- » Simple operation, built-in software
- » Universal connection to any microscope brand
- » Crisp 1080p images and videos
- » Live measurements function
- » Dual output mode (HDMI/WiFi)
- » High frame rate
- » Reliable color fidelity
- » C-mount connection (via dedicated adapter, on any microscope)
- » HDMI cable, Wireless adapter, mouse and SD card included
- » Downloadable, free of charge software
- » OPTIKA ProView for Windows



4 C-WH5 & C-WH5SC

Models:

C-WH5: WH5 camera, 1080p, 5 MP CMOS, Wi-Fi/HDMI, multi-plug

C-WH5SC: WH5 camera, 1080p, 5 MP CMOS, Wi-Fi/HDMI, with screen, multi-plug



C-WH5 & C-WH5SC - Specifications

C-WH5 & C-WH5SC

PC Camera resolution (MP)	5 MP
HDMI Camera resolution (MP)	2 MP
Digital camera resolution	1920 x 1080
HDMI Signal output	Yes
Sensor Size	1/1.8"
Sensor technology	CMOS
Sensor type	SONY
Image format	16/9
Pixel size	2.4x2.4 μm
Frame rate (HDMI)	60 fps (1920 x 1080 HDMI); 25fps (1920x1080) (WiFi)
Dynamic range	66 dB
Sensitivity	1120mV at 1/30s
Dark Signal	0.15mV at 1/30s
ADC conversion	8 Bit - 12Bit
Color Depth	1 Bit; 4 Bit; 8 Bit; 24 Bit
Exposure Time	0.03 msec - 918 msec
Binning	1x1
IR filter	380-650 nm (IR-cut filter)
Camera power	DC 12V 1A
C-mount	YES

C-WH5 & C-WH5SC



C-WH5 Contents:

- HDMI camera
- HDMI cable
- WiFi adapter
- SD card
- Wireless mouse
- Multi-plug external power supply



C-WH5SC Contents:

- HDMI camera
- HDMI monitor
- HDMI cable
- WiFi adapter
- SD card
- Wireless mouse
- Multi-plug external power supply (2 pcs.)



C-WH5SC - Monitor Specifications

MONITOR TECHNICAL SPECIFICATIONS (C-WH5SC)

Size	11,5"
Power supply	12V / 2,5A
HDMI cable	50 cm



2
MP

CMOS



HDMI



Impressive autofocusing FULL HD camera with 1080p, 2 MP resolution, CMOS sensor and HDMI connection, ensuring precise and ultra-fast automatic focus adjustment in any condition and in real time. Recommended for routine operations and perfect to compensate the lack of parfocality of the microscope without any user effort.

No software installation is required with image and video capturing on SD card.

Camera control panel shows exposure, white balance, color adjustment and sharpness when using mouse control.

Connection to the trinocular tube of any microscope brand via dedicated adapter (to be purchased separately).

Wireless mouse, SD card and built-in software included.

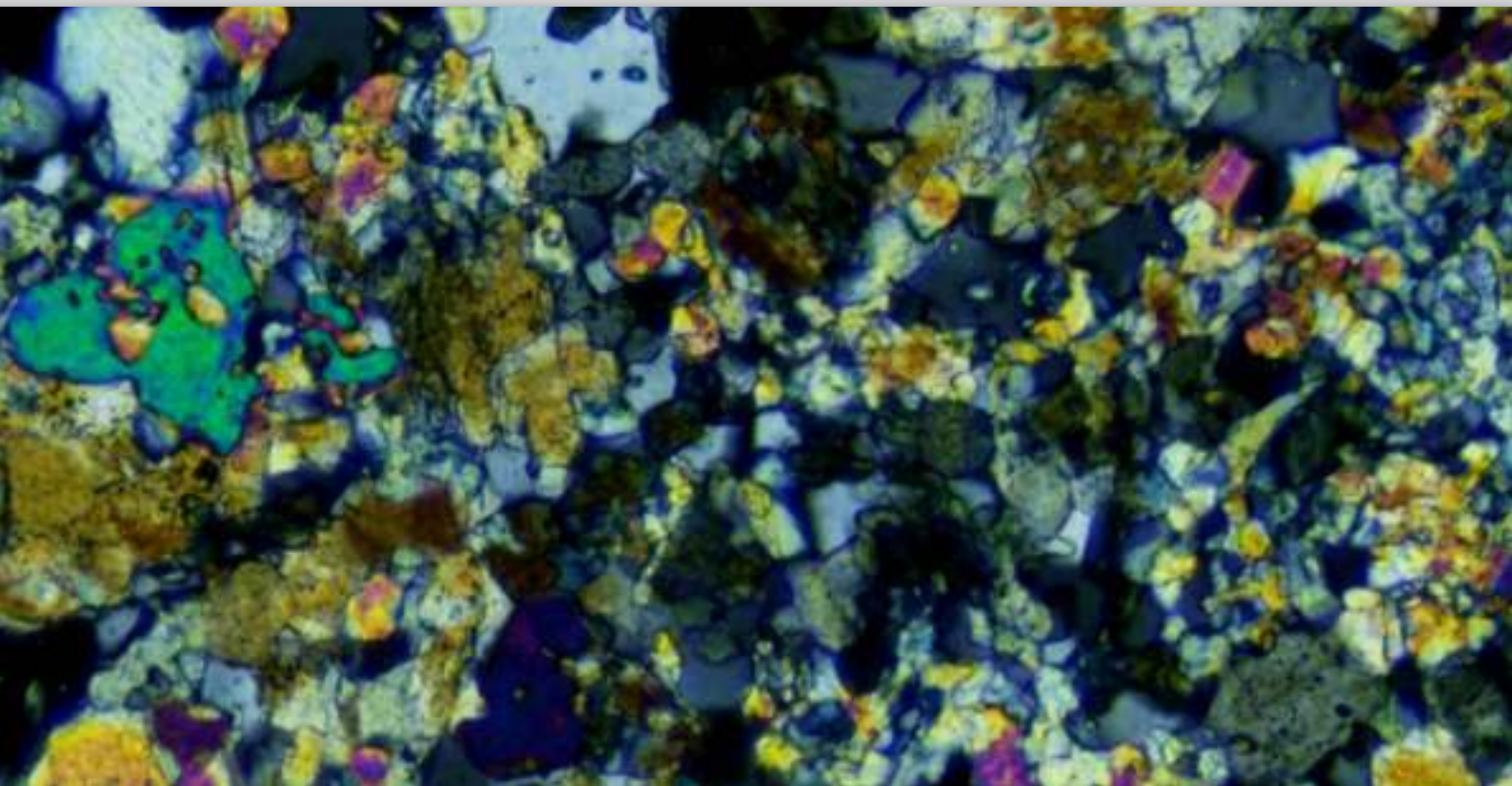

C-HA

- » Simple operation, built-in software
- » Universal connection to any microscope brand
- » Rapid autofocus system
- » Crisp 1080p images and videos
- » High frame rate
- » Reliable color fidelity
- » C-mount connection (via dedicated adapter, on any microscope)
- » HDMI cable, mouse and SD card included



4 C-HA

Model:

C-HA: HA autofocus camera, 2 MP CMOS, HDMI, multi-plug



C-HA Series - Specifications

	C-HA
HDMI camera resolution	2 MP (1920 x 1080)
HDMI Signal output	Yes
Sensor Size	1/2.8"
Sensor technology	CMOS
Sensor type	Aptina CMOS
Image format	16/9
Pixel size	2.9 x 2.9 μm
Frame rate full resolution	50 fps (1920 x 1080)
G Sensitivity	510mV at 1/30sec
Dark Signal	0.15mV at 1/30sec
ADC conversion	8 Bit
Color Depth	8 Bit
Exposure Time	Auto
Binning	1x1
Cooling Temperature	None
Camera Power	5V 2A
IR filter	380-650 nm (IR-cut filter)
CS-mount	YES
C-mount	YES



C-PGS Contents:

- USB camera
- USB 2.0 cable
- 30 & 30.5 mm rings
- C-mount projection lens
- Micrometric slide
- Wireless mouse
- SD card



C-HP4

8
MP

CMOS



USB-OUT

HDMI



Professional ultra-high definition yet very easy to use 4K camera with 2160p, 8 MP resolution, large SONY CMOS sensor and HDMI connection to clearly reveal the sample's finest details on-screen and perform measurements.

No software installation is required with image and video capturing on SD card when in HDMI mode.

At any time, it can be connected to PC and used via the downloadable, free of charge software (Windows), which is always available to enable the latest updates. The compact and elegantly designed housing conceals the very latest in camera technology.

Images will be of the highest quality and rich in contrast and detail with the top-class SONY sensors, worldwide recognized, ensuring beautiful true-to-life color and delivering incredibly accurate colors just as you see them.

Ideal to be connected to all the trinocular tube of different brands using the focusable C-Mount adapter (to be purchased separately). Wireless mouse, SD card and built-in software included.



C-HP4



C-H4K Contents:

- 4k Camera
- USB Cable 180cm
- HDMI Cable 150cm
- Wireless Mouse
- 16gb SD Card
- Calibration slide



- » Simple operation, built-in software
- » Universal connection to any microscope brand
- » Ultra HD 4K 2160p images and videos
- » Dual output mode (HDMI/USB)
- » High frame rate
- » Reliable color fidelity
- » C-mount connection (via dedicated adapter, on any microscope)
- » HDMI cable, mouse and SD card included
- » Downloadable, free of charge software
- » OPTIKA ProView for Windows



Model:

C-HP4: HP4 camera, 8 MP CMOS, USB/HDMI/4K, multi-plug

C-HP4 - Specifications

	C-HP4
PC Camera resolution (MP)	8 MP
HDMI Camera resolution (MP)	8 MP
Camera resolution (n° of pixels: W x H)	3840x2160
Color / Monochrome	Color
Sensor Size	1/1.8"
Sensor technology	CMOS
Sensor type	SONY
Image format	16/9
Pixel size	2.0 x 2.0 µm
Frame rate full resolution	30@ 3840x2160
G Sensitivity	505mV at 1/30s
Dark Signal	0.13mV at 1/30s
ADC conversion	8 Bit - 12 Bit
Color Depth	1 Bit; 4 Bit; 8 Bit; 24 Bit
Exposure Time	0.04 msec- 2 sec
Binning	1x1
IR filter	380-650 nm (IR-cut filter)
Camera power	12V 1A
C-mount	YES

4 C-HUB4K

- 8 MP
- CMOS
- 
- USB-OUT
- LAN
- HDMI
- 



Professional ultra-high definition yet very easy to use 4K camera with 2160p, 8 MP resolution, large SONY CMOS sensor and HDMI connection to clearly reveal the sample's finest details on-screen and perform measurements.

No software installation is required with image and video capturing on SD card when in HDMI mode.

At any time, it can be connected to PC and used via the downloadable, free of charge software (Windows), which is always available to enable the latest updates.

The compact and elegantly designed housing conceals the very latest in camera technology.

Images will be of the highest quality and rich in contrast and detail with the top-class SONY sensors, worldwide recognized, ensuring beautiful true-to-life color and delivering incredibly accurate colors just as you see them.

Ideal to be connected to all the trinocular tube of different brands using the focusable C-Mount adapter (to be purchased separately).

Wireless mouse, SD card and built-in software included.

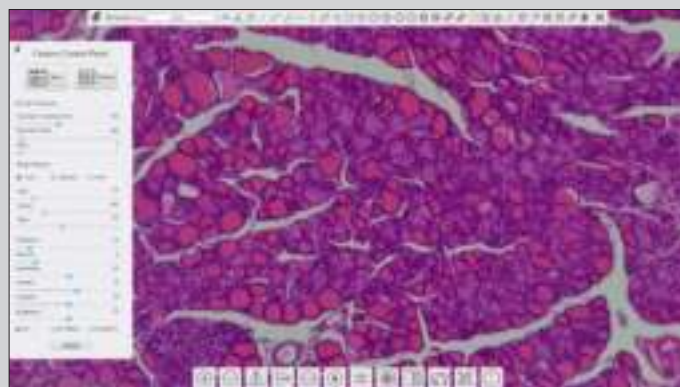
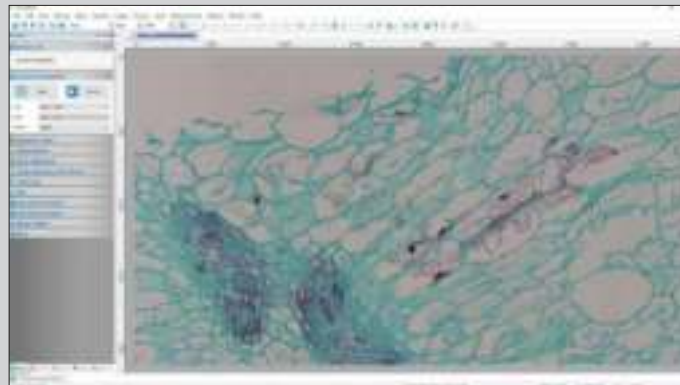
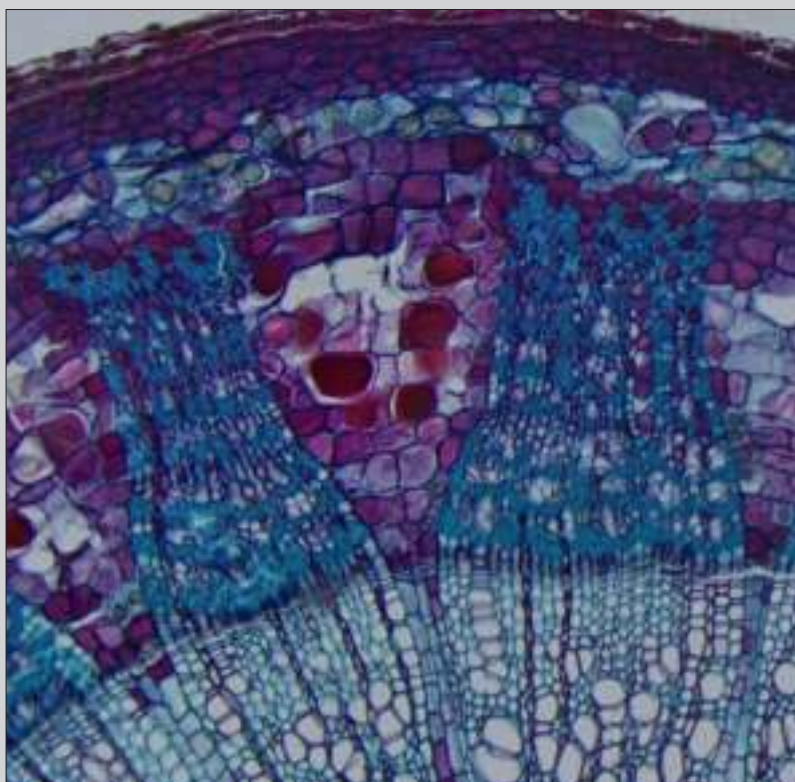

C-HUB4K



C-HUB4K Contents:

- 4k Camera
- USB Cable 180cm
- HDMI Cable 150cm
- Wireless Mouse
- 16gb SD Card
- Calibration slide



- » Simple operation, built-in software
- » Universal connection to any microscope brand
- » Ultra HD 4K 2160p images and videos
- » Dual output mode (HDMI/Ethernet)
- » High frame rate
- » Reliable color fidelity
- » C-mount connection (via dedicated adapter, on any microscope)
- » HDMI cable, mouse and SD card included
- » Downloadable, free of charge software
- » OPTIKA ProView for Windows



Model:

C-HUB4K: HUB4K Camera, 8Mp CMOS, 4K/USB/ETHERNET/WIFI multi video output

C-HUB4K - Specifications

	C-HUB4K
PC Camera resolution (MP)	8 MP
HDMI Camera resolution (MP)	8 MP
Camera resolution (n° of pixels: W x H)	3840x2160
Color / Monochrome	Color
Sensor Size	1/1.8"
Sensor technology	CMOS
Sensor type	SONY
Image format	16/9
Pixel size	2.0 x 2.0 µm
Frame rate full resolution	30@ 3840x2160
G Sensitivity	505mV at 1/30s
Dark Signal	0.13mV at 1/30s
ADC conversion	8 Bit - 12 Bit
Color Depth	1 Bit; 4 Bit; 8 Bit; 24 Bit
Exposure Time	0.04 msec- 2 sec
Binning	1x1
IR filter	380-650 nm (IR-cut filter)
Camera power	12V 1A
C-mount	YES

4 Camera Adapters Charts

		Upright			
		Monocular Binocular (Ø 23 mm)	Trinocular (Ø 23 mm)	Binocular (Ø 30 mm)	Trinocular
Camera model	Sensor size	Ecovision / B-60 / B-150 B-190-290 / B-380 (ALC)	B-190 / B-290 B-380 (with M-699)	B-510 / B-810 / B-1000	B-380 / B-510 B-810 / B-1000
C-P3	1/2.8"	M-115	M-115	M-115 + M-113.1	M-620
C-P6	1/1.8"	M-114	M-114	M-114 + M-113.1	M-620.1
C-P8	1/2.5"	M-115	M-115	M-115 + M-113.1	M-620.1
C-P20	1"	-	-	-	M-620.3
C-P5GS	2/3"	M-118	M-118	M-118 + M-113.1	M-620.2
C-HP	1/1.9"	M-114	M-114	M-114 + M-113.1	M-620.1
C-HPSC	1/1.9"	M-114	M-114	M-114 + M-113.1	M-620.1
C-WH5	1/1.8"	M-114	M-114	M-114 + M-113.1	M-620.1
C-WH5SC	1/1.8"	M-114	M-114	M-114 + M-113.1	M-620.1
C-HA	1/2.8"	M-115	M-115	M-115 + M-113.1	M-620
C-HP4	1/1.8"	M-114	M-114	M-114 + M-113.1	M-620.1
C-HUB4K	1/1.8"	M-114	M-114	M-114 + M-113.1	M-620.1



Camera Adapters Charts

Inverted	Stereo		
Trinocular	Binocular (Ø 30.5 mm)	Binocular (Ø 30 mm)	Trinocular
IM-3 / IM-5	SFX	SLX / SZ / SZP	SLX / SZ / SZP
M-620	M-115 + M-113.2	M-115 + M-113.1	M-620
M-620.1	M-114 + M-113.2	M-114 + M-113.1	M-620.1
M-620.1	M-115 + M-113.2	M-115 + M-113.1	M-620.1
M-620.3	-	-	M-620.3
M-620.2	M-118 + M-113.2	M-118 + M-113.1	M-620.2
M-620.1	M-114 + M-113.2	M-114 + M-113.1	M-620.1
M-620.1	M-114 + M-113.2	M-114 + M-113.1	M-620.1
M-620.1	M-114 + M-113.2	M-114 + M-113.1	M-620.1
M-620.1	M-114 + M-113.2	M-114 + M-113.1	M-620.1
M-620	M-115 + M-113.2	M-115 + M-113.1	M-620.1
M-620.1	M-114 + M-113.2	M-114 + M-113.1	M-620
M-620.1	M-114 + M-113.2	M-114 + M-113.1	M-620



v 7.5 - OPTIKA reserves the right to make corrections, modifications, enhancements, improvements and other changes to its products at any time without notice.

Headquarters and Manufacturing Facilities

OPTIKA® S.r.l. Via Rigla, 30 - 24010 Ponteranica (BG) - ITALY - Tel.: +39 035.571.392 - info@optikamicroscopes.com

Optika Sales branches

OPTIKA® Spain spain@optikamicroscopes.com
OPTIKA® China china@optikamicroscopes.com
OPTIKA® India india@optikamicroscopes.com

OPTIKA® North America namerica@optikamicroscopes.com
OPTIKA® Central America camerica@optikamicroscopes.com
OPTIKA® Africa africa@optikamicroscopes.com

High-End Microscope Cameras for Fluorescence Microscopy

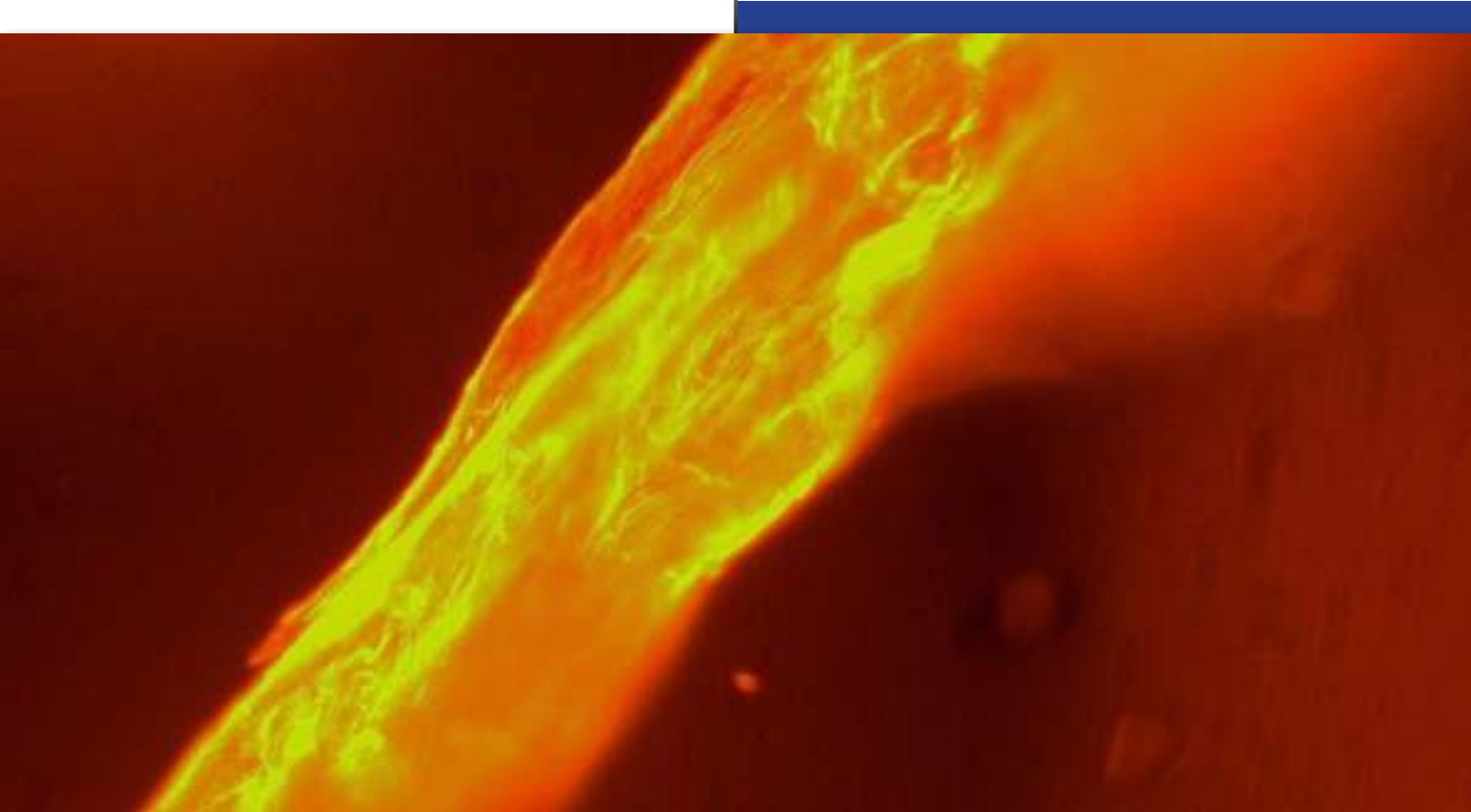

Large Selection of Best-in-class High Sensitivity Fluorescence Cameras

In order to detect the often low levels of fluorescence emitted by specimens, cameras used in fluorescence microscopy must have particular features, including high sensitivity and low noise, in order to capture as many photons as possible.

These cameras are typically equipped with CCD sensor, although nowadays there is always a larger selection of scientific-grade CMOS. Monochrome cameras are usually more suited to fluorescence imaging as they do not have a colour filter array, and enable more photons to reach the sensor, increasing their sensitivity very significantly compared to the color sensors.

The most indicated camera depends case by case, as it is of fundamental importance to consider the sample being imaged, the fluorochromes used, the required frame-rate, field of view, resolution and sensitivity.

All these elements drive to the selection of the right camera for a specific use.

④ High-Level Microscope Cameras

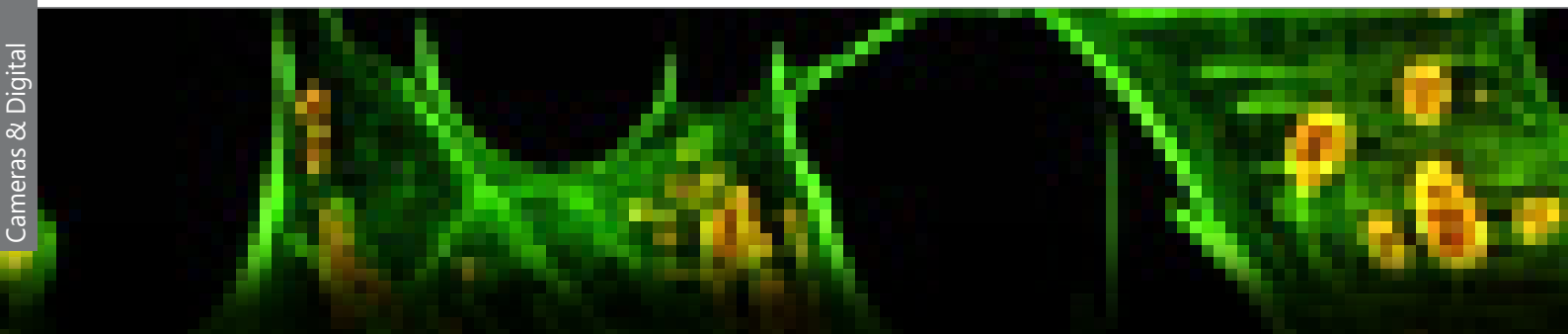

Cooled Scientific-grade CMOS Sensor, Rolling Shutter - C-P20CC & C-P20CM
 Cooled Scientific-grade CMOS Sensor, Global Shutter - C-P1CCGS & C-P1CMGS
 CCD Sensor, Rolling Shutter - C-P6FL

Model	C-P20CC	C-P20CM	C-P1CCGS	C-P1CMGS	C-P6FL
Sensor technology	Scientific-grade CMOS	Scientific-grade CMOS	Scientific-grade CMOS	Scientific-grade CMOS	CCD
Color / Monochrome	Color	Monochrome	Color	Monochrome	Color
Global / Rolling shutter	Rolling shutter	Rolling shutter	Global shutter	Global shutter	Rolling shutter
Resolution	20MP (5440 x 3648)	20MP (5440 x 3648)	1.7MP (1600 x 1100)	1.7MP (1600 x 1100)	6MP (2748 x 2200)
Frame rate	5 fps/10 fps/15 fps 30 fps	17.8 fps/41 fps/51 fps/64 fps	33 fps	94 fps	7.5 fps/14 fps
Sensitivity	426 mV at 1/30s	388 mV at 1/30s	4910 mV at 1/30s	8100 mV at 1/30s	1000 mV at 1/30s
Cooling system	Yes	Yes	Yes	Yes	No



High-Level Microscope Cameras

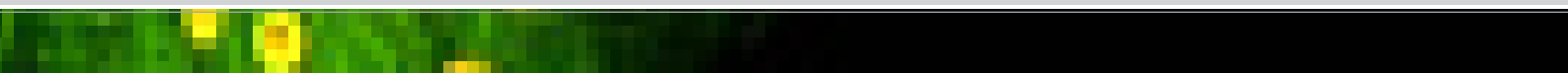
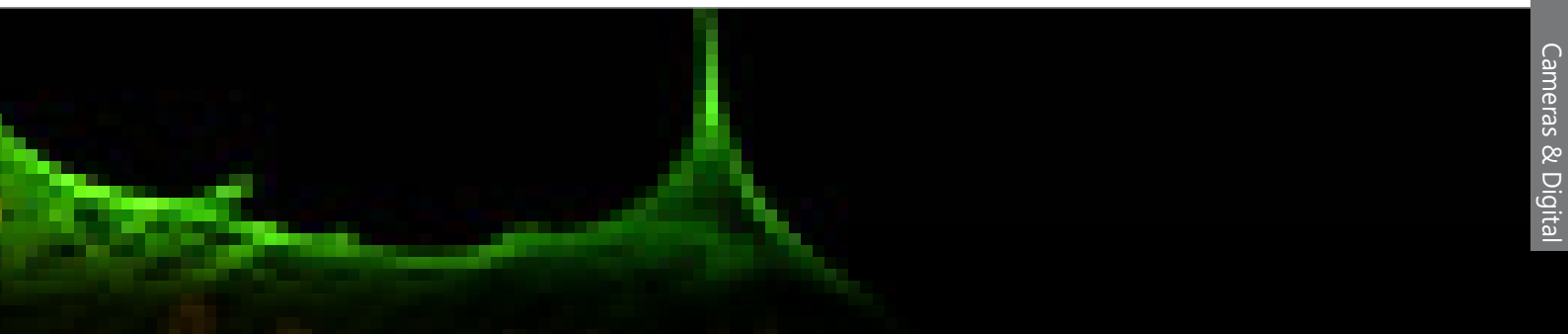

C-P1CCGS & C-P1CMGS

1.3/18
MP

CMOS



USB-OUT



Superb, stunning global shutter SONY EXMOR CMOS cameras with low resolution (1.7 MP), cooled large sensor and USB3.0 connection, recommended for specific scientific applications especially connected to fluorescence microscopy. Main key-points are the global shutter featuring its sensitivity, which makes this series impressive both with fast-moving specimens and in low-light fluorescence, especially thanks to the cooling function. Choose the monochrome version for superb sensitivity, being perfect for fluorescence imaging.

The compact and elegantly designed housing conceals the very latest in camera technology. Images will be of the highest quality and rich in contrast and detail with the top-class SONY sensors, worldwide recognized, ensuring beautiful true-to-life color and delivering incredibly accurate colors just as you see them. Ideal to be connected to all the trinocular tube of different brands using the focusable C-Mount adapter (to be purchased separately).

Downloadable, free of charge software (Windows, Mac OS or Linux) is always available to enable the latest updates.

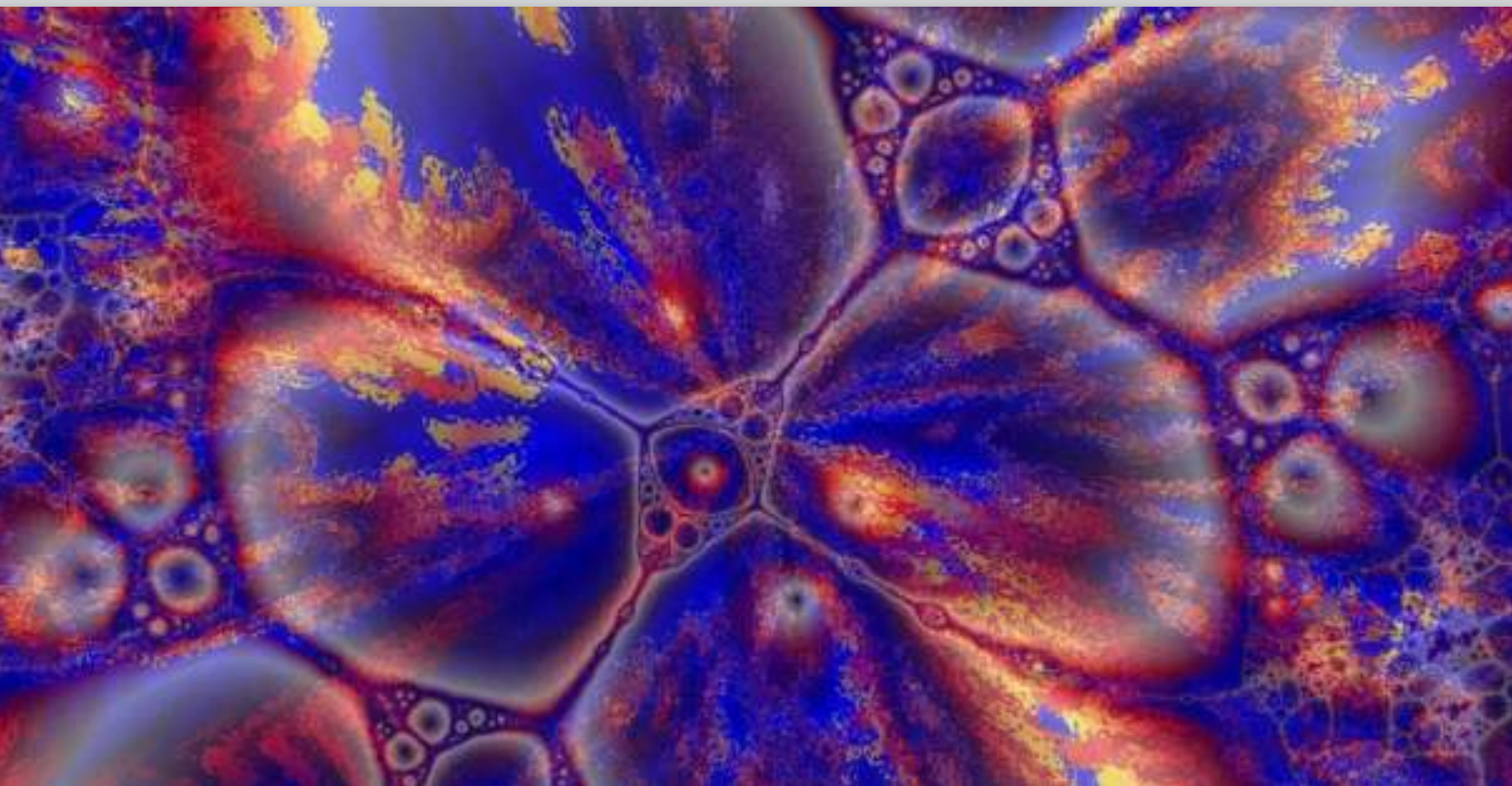

C-P1CCGS & C-P1CMGS

C-P1CCGS

- » Recommended for special applications, including fluorescence
- » Simple operation, driver-free
- » Top-class, large SONY EXMOR sensor
- » Cooling system for enhanced sensitivity
- » Global shutter for impressive performance on moving samples
- » Universal connection to any microscope brand
- » Crisp 1.7 MP images
- » USB3.0 for impressive high frame rate
- » Incredibly accurate colors
- » USB cable and calibration slide included
- » Downloadable, free of charge software
- » OPTIKA ProView & LiteView for Windows
- » OPTIKA LiteView for Mac OS or Linux



C-P1CCGS & C-P1CMGS

Models:

C-P1CCGS: High Performance USB 3.0 C-mount Cooled Color Microscope Camera

C-P1CMGS: High Performance USB 3.0 C-mount Cooled Monochrome Microscope Camera



C-P1CCGS & C-P1CMGS - Specifications

CAMERA TECHNICAL SPECIFICATIONS	C-P1CCGS	C-P1CMGS
Digital camera resolution	1.7 MP (1600 x 1100)	1.7 MP (1600 x 1100)
Signal output	USB 3.0	USB 3.0
Color / Monochrome	Color	Monochrome
Sensor Size	1.1"	1.1"
Sensor technology	CMOS	CMOS
Sensor type	SONY EXMOR	SONY EXMOR
Image format	3/2	3/2
Pixel size	9.0 x 9.0 μm	9.0 x 9.0 μm
Frame rate full resolution	33 fps (1600 x 1100)	94 fps (1600 x 1100)
G Sensitivity	4910mV at 1/30s	8100mV at 1/30s
Dark Signal	0.3mV at 1/30s	0.3mV at 1/30s
ADC conversion	8 Bit - 12 Bit	14 Bit
Color Depth	1 Bit ; 4 Bit; 8 Bit; 24 Bit	-
Exposure Time	0.1 msec - 3600 sec	0.1 msec - 3600 sec
Binning	1x1	1x1
IR filter	380-650 nm (IR-cut filter)	380-650 nm (IR-cut filter)
Cooling Temperature	-45°C	-45°C
Cooling power	12V 3A	12V 3A
Camera power	PC USB	PC USB
C-mount	YES	YES

C-P1CCGS & C-P1CMGS



C-P1CCGS & C-P1CMGS Contents:

- USB camera
- USB 3.0 cable
- Calibration slide
- External power supply



1.7
MP

CMOS



USB-OUT



Top-class, easy to operate SONY EXVIEW CCD camera with high resolution (6 MP), large sensor and USB3.0 connection, recommended for specific scientific applications especially connected to fluorescence microscopy. Its particular sensitivity is relevantly important in low-light fluorescence, and if small changes in fluorescence need to be detected, determining how clear the image produced is. The compact and elegantly designed housing conceals the very latest in camera technology.

Images will be of the highest quality and rich in contrast and detail with the top-class SONY sensors, worldwide recognized, ensuring beautiful true-to-life color and delivering incredibly accurate colors just as you see them.

Ideal to be connected to all the trinocular tube of different brands using the focusable C-Mount adapter (to be purchased separately). Downloadable, free of charge software (Windows, Mac OS or Linux) is always available to enable the latest updates.

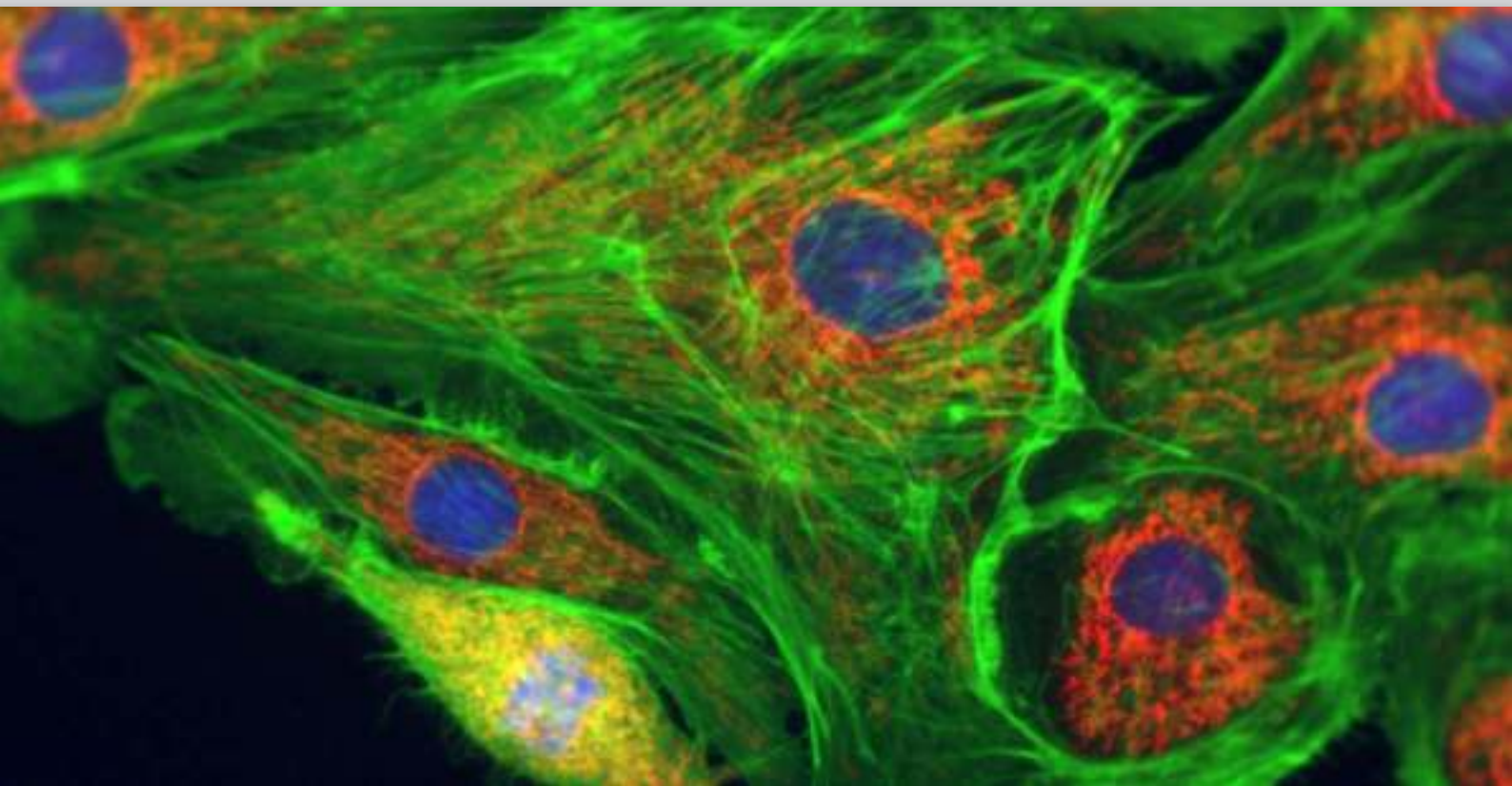

C-P6FL

- » Recommended for special applications, including fluorescence
- » Simple operation, driver-free
- » Top-class, large SONY EXVIEW CCD sensor
- » Significant sensitivity for a non-cooled camera
- » Universal connection to any microscope brand
- » Crisp 6 MP images
- » USB3.0 for impressive high frame rate
- » Incredibly accurate colors
- » USB cable and calibration slide included
- » Downloadable, free of charge software
- » OPTIKA ProView & LiteView for Windows
- » OPTIKA LiteView for Mac OS or Linux
- » C-mount connection (via dedicated adapter, on any microscope)



4 C-P6FL

Model:

C-P6FL: High Performance USB 3.0 C-mount Microscope Camera



C-P6FL - Specifications

CAMERA TECHNICAL SPECIFICATIONS	C-P6FL
Digital camera resolution	6 MP (2748 x 2200)
Signal output	USB 3.0
Color / Monochrome	Color
Sensor Size	1"
Sensor technology	CCD
Sensor type	SONY EXVIEW
Image format	5/4
Pixel size	4.54 x 4.54 μ m
Frame rate full resolution	7.5 fps (2748 x 2200)
Frame rate other resolution	14 fps (2748 x 1092)
Dynamic range (DB)	62
G Sensitivity	1000mV at 1/30s
Dark Signal	8mV at 1/30s
ADC conversion	8 Bit - 12 Bit
Color Depth	1 Bit ; 4 Bit; 8 Bit; 24 Bit
Exposure Time	0.06 msec - 1000 sec
Binning	1x1
IR filter	380-650 nm (IR-cut filter)
Camera power	PC USB
C-mount	YES

C-P6FL

C-P6FL Contents:

- USB camera
- USB 1.8 cable
- Calibration slide



C-P20CC & C-P20CM

20
MP

CMOS



USB-OUT



C-P20CC



C-P20CM

Ultra-professional yet intuitive cameras with incredibly high resolution (20 MP), cooled large SONY EXMOR CMOS sensor and USB3.0 connection, recommended for specific scientific applications especially connected to fluorescence microscopy. The cooling system affects sensitivity and therefore image clarity. Choose the monochrome version for superb sensitivity, being perfect for fluorescence imaging. The high resolution makes these models interesting also for morphological imaging, patch clamping and network studies. The compact and elegantly designed housing conceals the very latest in camera technology. Images will be of the highest quality and rich in contrast and detail with the top-class SONY sensors, worldwide recognized, ensuring beautiful true-to-life color and delivering incredibly accurate colors just as you see them. Ideal to be connected to all the trinocular tube of different brands using the focusable C-Mount adapter (to be purchased separately). Downloadable, free of charge software (Windows, Mac OS or Linux) is always available to enable the latest updates.

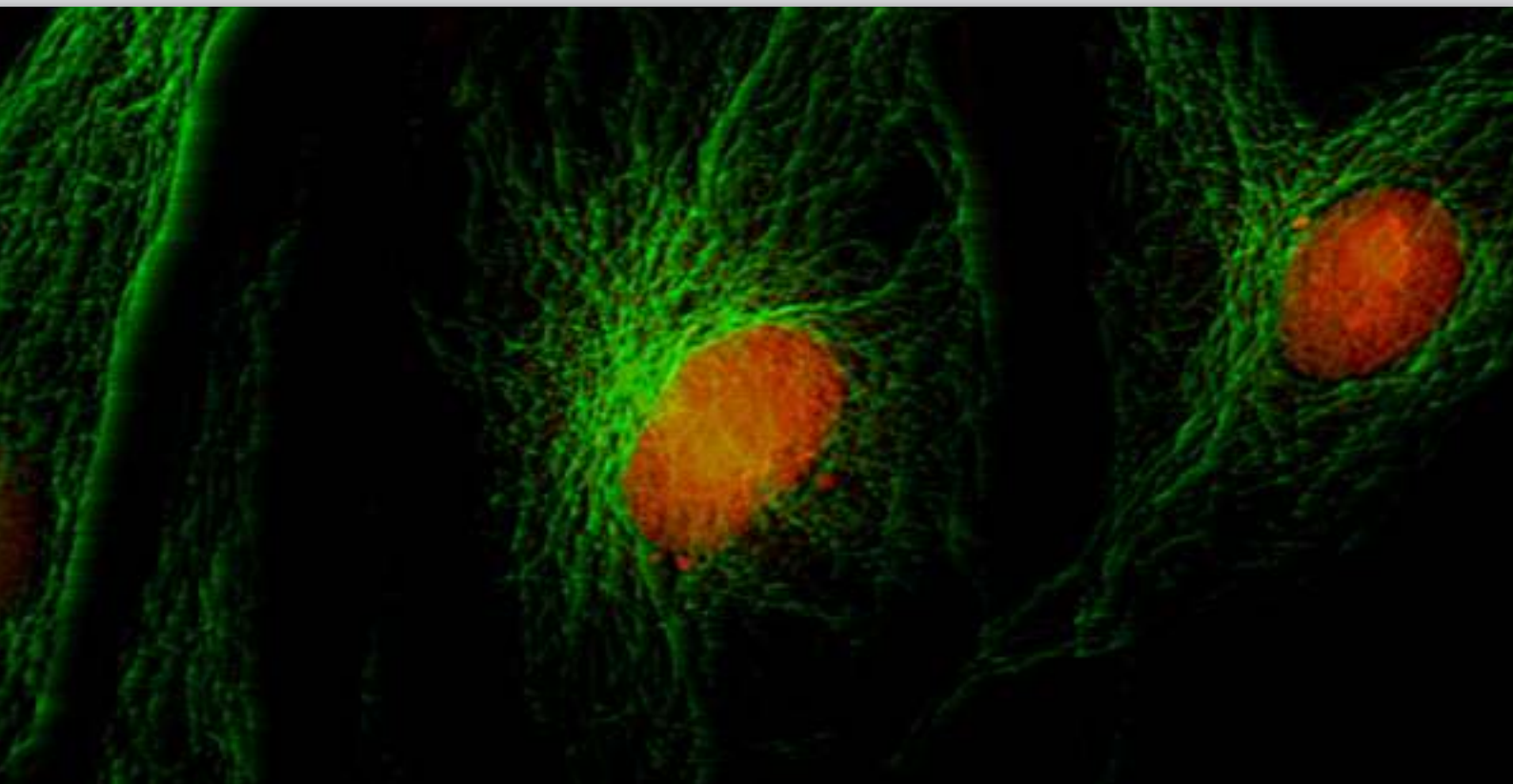

C-P20CC & C-P20CM

C-P20CC

- » Recommended for special applications, including fluorescence
- » Simple operation, driver-free
- » Top-class, large SONY EXMOR sensor
- » Cooling system for enhanced sensitivity
- » Universal connection to any microscope brand
- » Crisp 20 MP images
- » USB3.0 for impressive high frame rate
- » Incredibly accurate colors
- » USB cable and calibration slide included
- » Downloadable, free of charge software
- » OPTIKA ProView & LiteView for Windows
- » OPTIKA LiteView for Mac OS or Linux

④ C-P20CC & C-P20CM

Models:

C-P20CC: Pro Cooled Color camera, 20 MP CMOS, USB3.0

C-P20CM: Pro Cooled Monochromatic camera, 20 MP CMOS, USB3.0



C-P20CC & C-P20CM - Specifications

CAMERA TECHNICAL SPECIFICATIONS	C-P20CC	C-P20CM
Digital camera resolution	20 MP (5440 x 3648)	20 MP (5440 x 3648)
Signal output	USB 3.0	USB 3.0
Color / Monochrome	Color	Monochrome
Sensor Size	1"	1"
Sensor technology	CMOS	CMOS
Sensor type	SONY EXMOR	SONY EXMOR
Image format	3/2	3/2
Pixel size	2.4 x 2.4 µm	2.4 x 2.4 µm
Frame rate full resolution	5 fps (5440 x 3648)	17.8 fps (5440 x 3648)
Frame rate other resolution	10 fps (4096x2160); 15 fps (2736x1824); 30fps (1824x1216)	41 fps (4096 x 2160); 51 fps (2736x1824); 64 fps (1824x1216)
G Sensitivity	426mV at 1/30s	388mV at 1/30s
Dark Signal	0.21mV at 1/30s	0.21mV at 1/30s
ADC conversion	8 Bit - 12 Bit	14 Bit
Color Depth	1 Bit ; 4 Bit; 8 Bit; 24 Bit	-
Exposure Time	0.1 msec - 3600 sec	0.1 msec - 3600 sec
Binning	1x1; 2x2; 3x3	1x1; 2x2; 3x3
IR filter	380-650 nm (IR-cut filter)	380-650 nm (IR-cut filter)
Cooling Temperature	-45°C	-45°C
Cooling power	12V 3A	12V 3A
Camera power	PC USB	PC USB
C-mount	YES	YES

C-P20CC & C-P20CM

C-P20CC & C-P20CM Contents:

- USB camera
- USB 3.0 cable
- Calibration slide
- External power supply



4 Camera Adapters Charts

		Upright			
		Monocular Binocular (O 23 mm)	Trinocular (O 23 mm)	Binocular (O 30 mm)	Trinocular
Camera model	Sensor size	Ecovision / B-60 / B-150 B-190-290 / B-380 (ALC)	B-190 / B-290 B-380 (with M-699)	B-510 / B-810 / B-1000	B-380 / B-510 B-810 / B-1000
C-P20CC	1"	-	-	-	M-620.3
C-P20CM	1"	-	-	-	M-620.3
C-P1CCGS	1,1"	-	-	-	M-620.3
C-P1CMGS	1,1"	-	-	-	M-620.3
C-P6FL	1"	-	-	-	M-620.3

M-620.3



Camera Adapters Charts

Inverted	Stereo		
Trinocular	Binocular (O 30.5 mm)	Binocular (O 30 mm)	Trinocular
IM-3 / IM-5	SFX	SLX / SZM / SZ / SZP	SLX / SZM / SZ / SZP
M-620.3	-	-	M-620.3
M-620.3	-	-	M-620.3
M-620.3	-	-	M-620.3
M-620.3	-	-	M-620.3
M-620.3	-	-	M-620.3



v 7.5 - OPTIKA reserves the right to make corrections, modifications, enhancements, improvements and other changes to its products at any time without notice.

Headquarters and Manufacturing Facilities

OPTIKA® S.r.l. Via Rigla, 30 - 24010 Ponteranica (BG) - ITALY - Tel.: +39 035.571.392 - info@optikamicroscopes.com

Optika Sales branches

OPTIKA® Spain spain@optikamicroscopes.com
OPTIKA® China china@optikamicroscopes.com
OPTIKA® India india@optikamicroscopes.com

OPTIKA® North America namerica@optikamicroscopes.com
OPTIKA® Central America camerica@optikamicroscopes.com
OPTIKA® Africa africa@optikamicroscopes.com

OPTIKA SOFTWARE

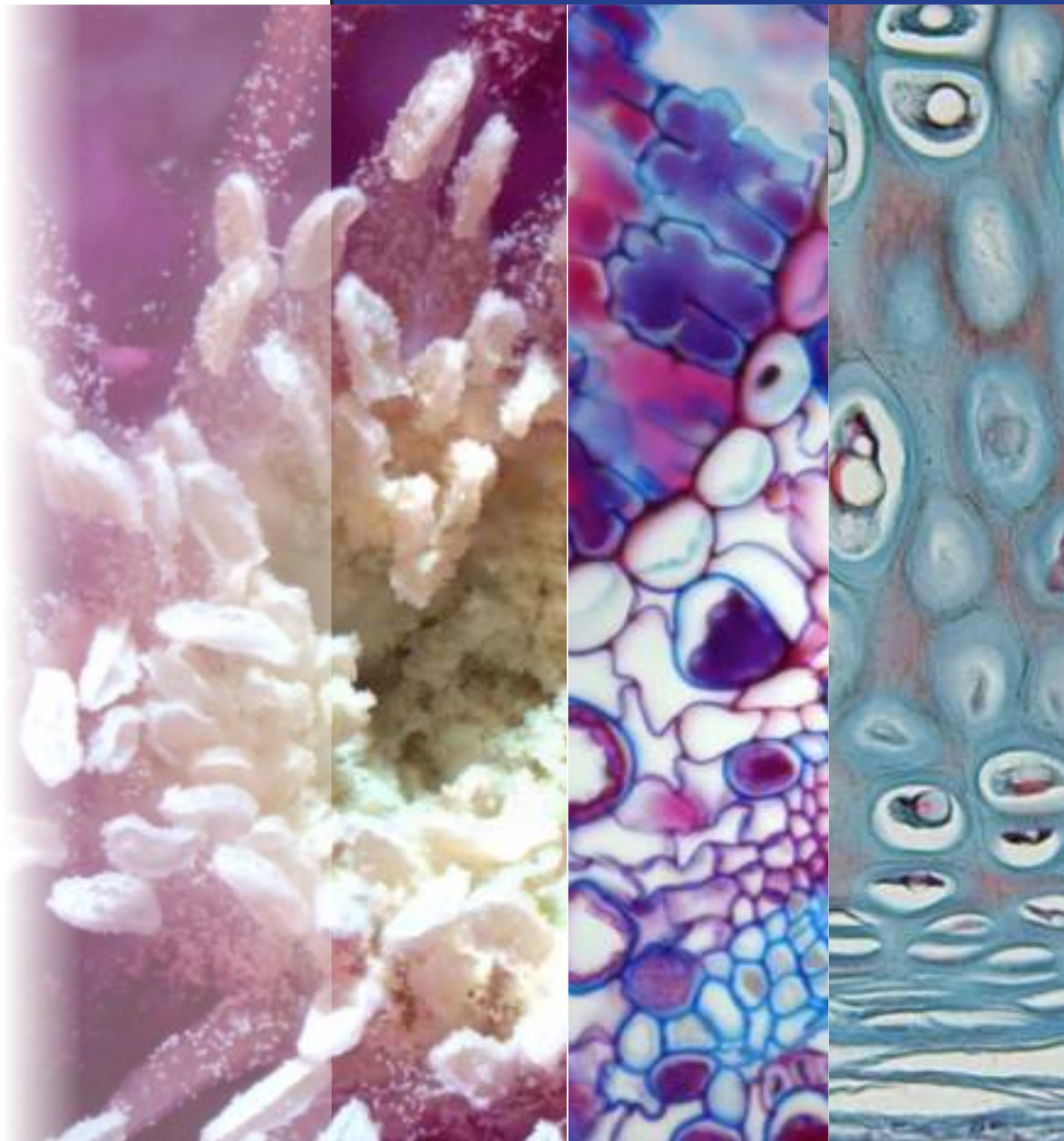

OPTIKA SOFTWARE SUITES

OPTIKA SOFTWARE - Comparison chart

Software

- Before proceeding with the SW installation, please check the table below "Software Function list" to identify the most suitable software.



SOFTWARE FUNCTION LIST

FUNCTION		OPTIKA PRO VIEW	OPTIKA LITE VIEW	OPTIKA VISION LITE	
GENERAL	Simultaneous management of several cameras	X	X	X	
	GUI (Graphical User Interface)	X			
	Report generator	X		X	
	Archiving	X	X	X	
	Language	Catalan	X	X	
		Chinese (simpl.)	X	X	
		Chinese (trad.)	X	X	
		Korean	X	X	
		English	X	X	X
		French	X	X	X
		German	X	X	X
		Indonesian	X	X	
		Italian	X	X	X
		Japanese	X	X	
		Polish	X	X	X
		Russian	X	X	
		Spanish	X	X	X
Swedish			X		
Thai	X	X			
Turkish	X	X			

FUNCTION		OPTIKA PRO VIEW	OPTIKA LITE VIEW	OPTIKA VISION LITE	
MEASUREMENTS	Measurements on "live"	X			
	Measurements on "captured"	X		X	
	2D Measurements	Line	X		X
		Angle	X		
		Parallel lines	X		
		Rectangle	X		
		Ellipse	X		
		Circle	X		
		Annulus	X		
		Arc	X		
		Curve	X		
	Polygon	X			
Particle count	X				
Export to Excel	X		X		

OPTIKA SOFTWARE - Comparison chart

SOFTWARE FUNCTION LIST

FUNCTION		OPTIKA PRO VIEW	OPTIKA LITE VIEW	OPTIKA VISION LITE	
IMAGE ACQUISITION	Simultaneous management of several cameras	X	X		
	IMAGE acquisition	X	X	X	
	Image formats	tiff	X	X	X
		jpg	X	X	X
		bmp	X	X	X
		png	X	X	
		pcx	X	X	
		jp2	X	X	
		dcm	X	X	
	IMAGE acquisition	X	X	X	
	VIDEO formats	avi	X	X	X
		wmv	X	X	X
		mp4	X	X	X
		asf	X	X	X
		3gp	X	X	X
		mov	X	X	X
		h264	X	X	X
		h265	X	X	X
	Continuous automatic exposure	X	X	X	
	Manual Exposure	X	X	X	
	Mobile spot for exposure	X	X	X	
	Resizable spot for exposure	X	X	X	
	Colour acquisition	X	X	X	
	Grey-scale acquisition	X	X	X	
	Manual Time-Lapse	X		X	
	Automatic Time-Lapse	X			
	Fast Image Acquisition	X	X	X	
	Focus Indicator	X			
	White Balance	X	X	X	
	Black balance	X			
Background correction	X				
Dark Field Correction	X	X			
Image Enhancement	X	X	X		
Live Histogram	X	X	X		
Flip	Horizontal	X	X	X	
	Vertical	X	X	X	
Rotate	X				

FUNCTION		OPTIKA PRO VIEW	OPTIKA LITE VIEW	OPTIKA VISION LITE
PROCESSING	Several function of image processing (filters)	X		
	Multiple image combining	X		
	EDF (Extended Depth of Focus)	X		
	Colour Combine (Multi-Fluorescence Imaging)	X		
	Shift Correction	X		
	HDR (High Dynamic Range)	X		
	Layer Management	X		X
	Text Overlay	X		
	Ruler Overlay	X		
	Measurement Overlay	X		
	Grids	X		X

4083.Wifi, 4083.4 and 4083.EC2 work with Vision Lite only. Cameras with HDMI connection only, do not require any software.

4 OPTIKA Vision Lite - Extremely Intuitive Software

Optika Vision Lite has been designed and developed to be incredibly intuitive, simple and easy to use for customers needing a convenient solution to be combined with OPTIKAM cameras.

- » Friendly interface, multilanguage
- » Capture still images & stream live videos
- » Perform linear measurements
- » Export comprehensive reports

Friendly interface, multilanguage

Engineered for easy user interaction and optimized image acquisition, the main purpose of OPTIKA Vision Lite is ensure clear communication.

- An efficient means to efficiently completing your jobs
- Pleasant, easy-to-navigate menus
- Eight languages pre-installed, others upgradable

Capture still images & stream live videos

Use the live preview to accurately focus your image and change parameters to obtain the perfect final result you are looking for. Images can be saved in different formats and even as test reports, including personal comments.

Additional features:

- Image stack acquisition
- Grid addition for rapid considerations
- Image flipping option available

Perform linear measurements

Perform linear measurements in an extremely way just by drawing a line after creating your preferred calibration based on the magnification.

- Accurate measurements through simple calibration
- Comprehensive data export (notes & measures included)
- Indicate particular objects in the image to add persona comments

Export comprehensive reports

Detailed test reports can be generated, printed and saved. Reports can be also customized with company logos.

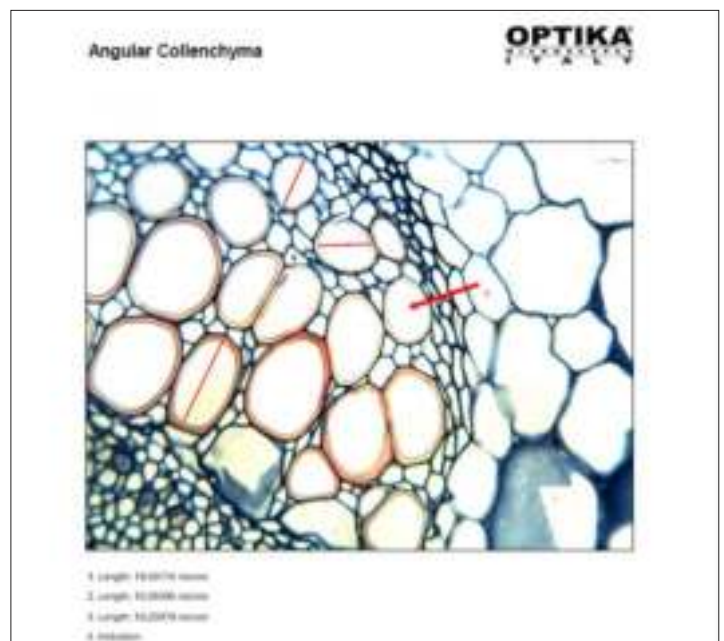
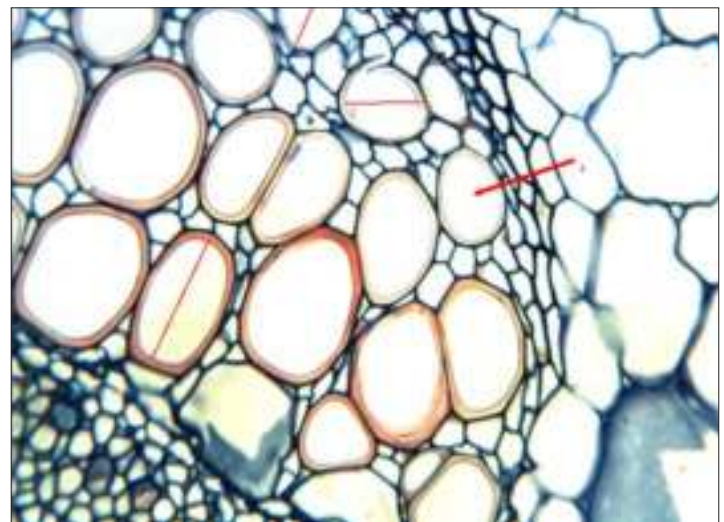
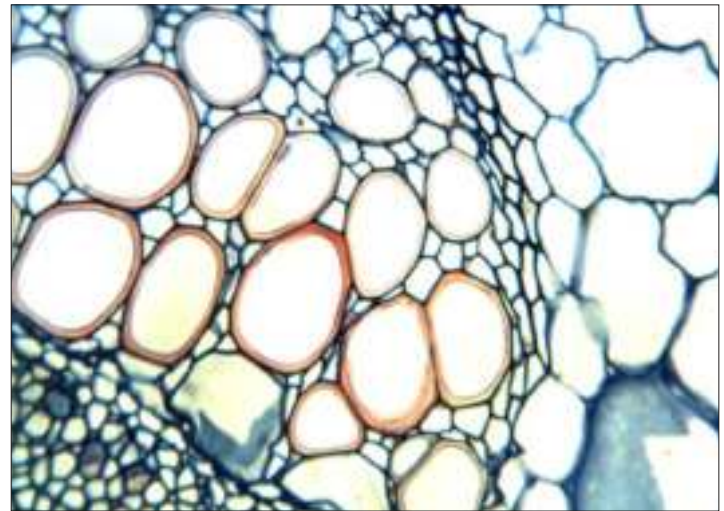

OPTIKA LITEView is a basic image acquisition software. The user who simply wants acquire a still image or a video, with no need to perform measurements, has, with this powerful and intuitive software, the perfect solution.

-) Simple management of «live» image
-) Acquisition of still images or video
-) Basic imaging functions
-) Background correction

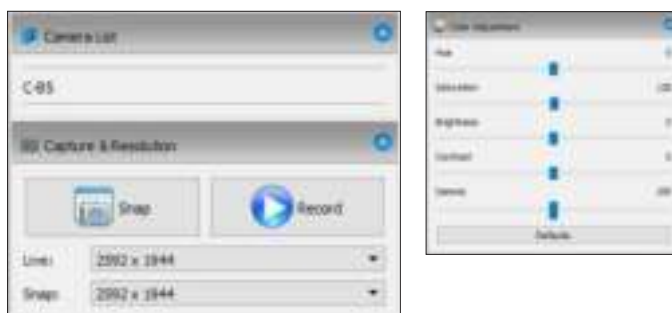

Simple management of «live» image

Image preview is freely customizable by the user. A simple White Balance function with a mobile spot allows to perform the balance even on very small areas, once the specimen has been framed and focused.

Basic functions:

- Automatic or manual acquisition
- Possibility to have «live» and «capture» at different resolutions
- White Balance with mobile spot
- Background correction for the acquisition of perfectly illuminated images.

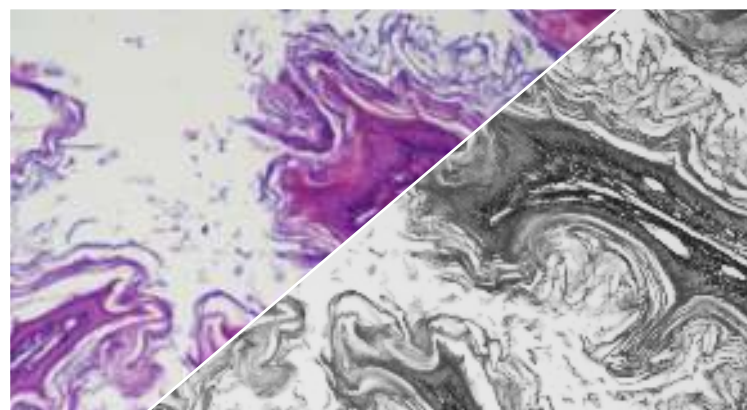

Color / Grey scales

Capturing still images or video

Just select the option and the software performs: acquiring still images or videos is simply and intuitive.

Basic imaging functions

Image parameters can be modified according user's needs. Color, Contrast and Gamma can be changed in real time.

More, it is possible to use a color camera in «SGrey Scales» modo in order to increase the camera sensitivity.

Background Correction

Any inhomogeneity of illumination of the microscope can be corrected by using the background correction function.

This allows to obtain a faithful reproduction of the image without annoying inhomogeneity due to a not perfect illumination.



No Background correction



With Background correction

OPTIKA PROView is a professional image analysis software. The user who needs to acquire an image or video and to perform a series of processings or measurements, can easily achieve incredible results thanks to this software. PROView incorporates all the functions of the LITEView package, but in addition allows:

- White Balance and Black Balance
- Simultaneous management of several cameras
- Graphical User Interface fully customizable
- Imaging of Multichannel Fluorescence Images with «pixel shift» function
- Multilanguage Software

Beginners? Experts?

An «On-line» manual will help any user (no matter on how expert he can be) to get the best from the software

Images always perfect

The management of the acquisition parameters allows to get always the best from your camera. White balance, black balance, background correction, «live» management of Colors, Contrast, Gamma, Gain and Exposure Time ensure to obtain a faithful image. A numerical focus indicator will ensure an optimal focusing, also on specimens with different focal planes.

White Balance and Black Balance

It is possible to obtain the balance either on the whole frame or on a small ROI (Region Of Interest) of the image simply resizing and moving the spot in one part of the specimen

Multichannel Fluorescence Image processing

Acquire fluorescence images with a specific filtercube, use a false color for the used fluorochrome, get a single multichannel image is simply and intuitive.

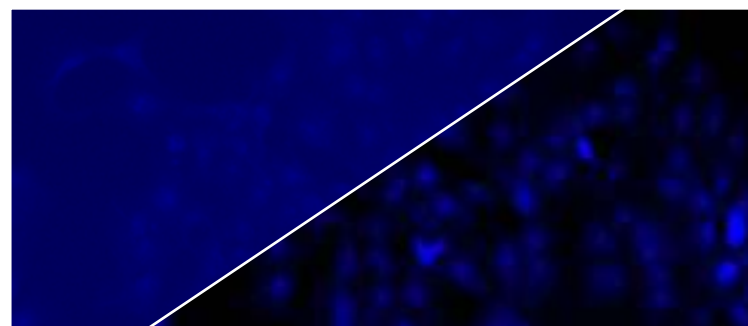

No black correction / Black correction

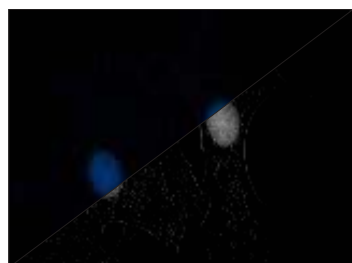

DAPI (UV)

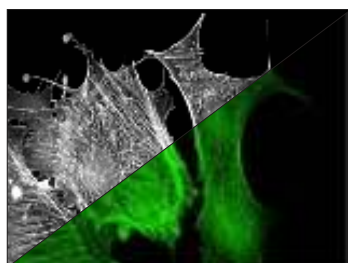

FITC (B)

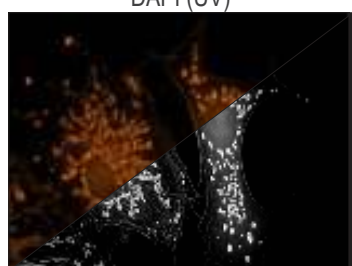

TEXAS RED (G)

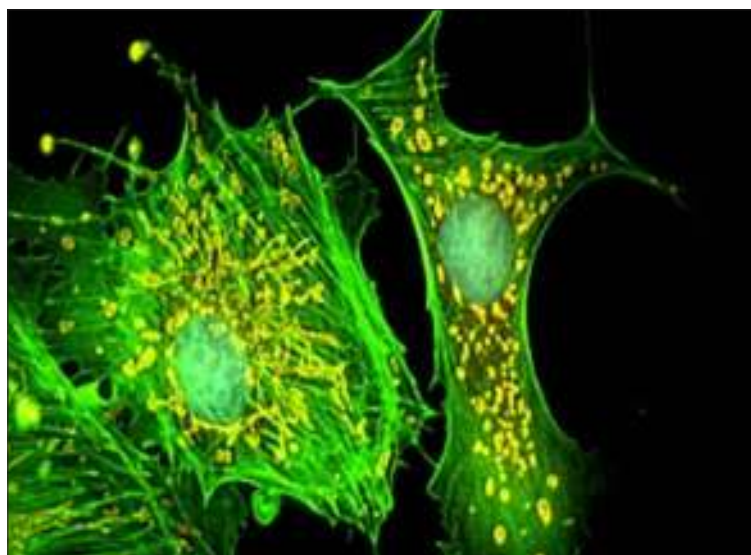

Combined multichannel image

«Pixel Shift» function

Fluorescence filter cubes, sometimes, are not perfectly aligned.

During acquisition of multichannel fluorescence images, this can cause a non perfect overlapping of the different signals, making the colocalization calculation almost impossible.

«Pixel Shift» function allows to correct these small misalignments:

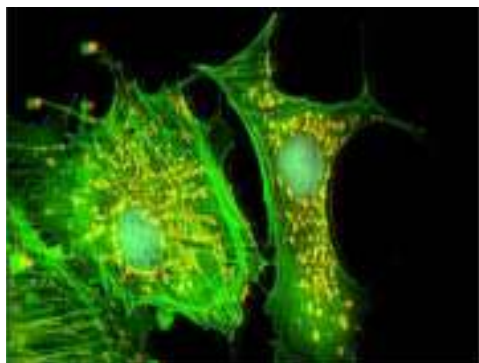

Original image

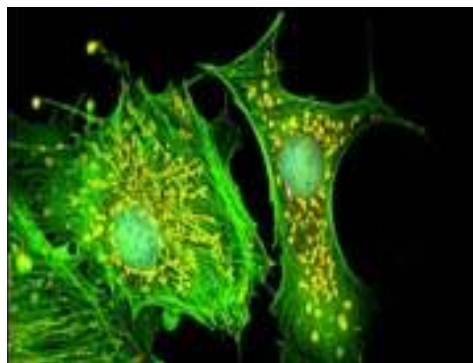

Corrected image

HDR (High Dynamic Range) acquisition

Acquisition of different images with different exposure times allows this function to create a final image where bright and dark zones of the specimen are perfectly displayed.



Standard Dynamic Range

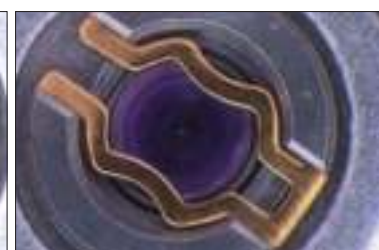

High Dynamic Range

Extended Depth of Focus (EDF)

Acquire images with different focal planes, specially on specimens observed under a stereomicroscope, and to obtain a focused final image with a theoretical infinite focus. **EDF** function (also known as «Z-stack») allows a very refined image processing.



Single Focal Plane Images



EDF Image

Stitching & Tiling

Get an image with high resolution but, at the same time, have a wide view of the specimen under observation.

Impossible? No. The multiple image alignment function allows to get a single image starting from adjacent images of the specimen.

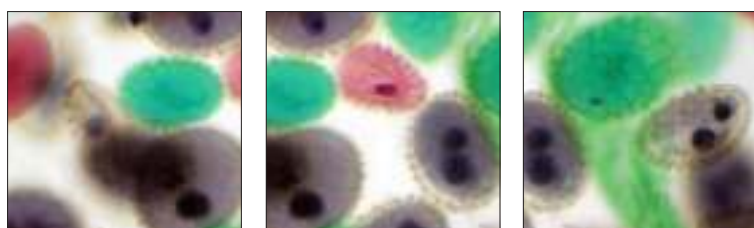

Separate Images



Stitched image

Measurements

User can perform measurements on the «live» image (no need to capture an image) and on captured images.

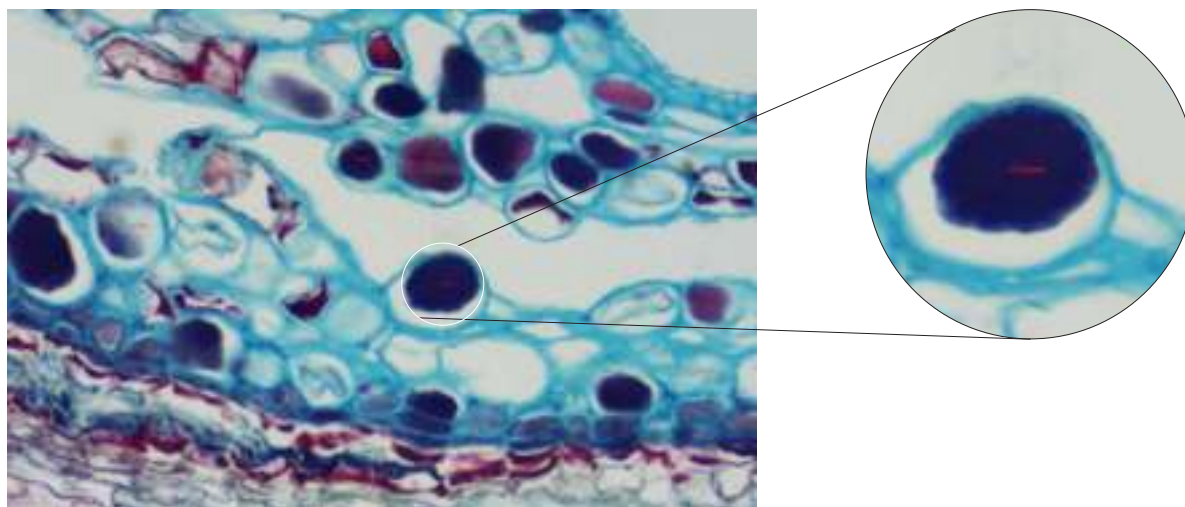

From Beginners To Experts

Measurements available:

- linear measurements
- angles
- circles
- annuli
- polygons
- touch count



Report Generator

At the end of the analysis it is possible to export images and measurement results either on a Excel sheet and on a Report Generator in MS Word format.

The template is freely configurable and can be modified according to laboratory standards.

OPTIKA
ITALY Testing Material Lab
Test Report

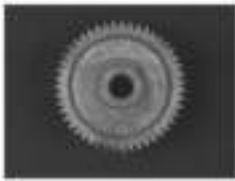
Specimen: Gear
Material: Cast Iron
Test: Macro + Micro
Production Batch: 0Y-04-2008
Date: 2018-04-10 08:40:09



Index	Length(um)	Angle(°)	Distance(um)
1	16154718.46, 16128120.00	179.94	1219175.89

Comments: _____

Operator: _____ Chief of Laboratory: _____

v 7.5 - OPTIKA reserves the right to make corrections, modifications, enhancements, improvements and other changes to its products at any time without notice.

Headquarters and Manufacturing Facilities

OPTIKA® S.r.l. Via Rigla, 30 - 24010 Ponteranica (BG) - ITALY - Tel.: +39 035.571.392 - info@optikamicroscopes.com

Optika Sales branches

OPTIKA® Spain spain@optikamicroscopes.com
OPTIKA® China china@optikamicroscopes.com
OPTIKA® India india@optikamicroscopes.com

OPTIKA® North America namerica@optikamicroscopes.com
OPTIKA® Central America camerica@optikamicroscopes.com
OPTIKA® Africa africa@optikamicroscopes.com

OPTISCAN



OPTISCAN10
Digital scanner

4 OPTISCAN10 - 4083.SC10

CONVERT YOUR GLASS SLIDES INTO DIGITAL DATA !

Rapid and high resolution scanner to convert your slides into digital slides. The digital slide can be easily manipulated to see any location at any magnifications. Digitizing slides opens up a variety of new possibilities, like:

- Creating a database to be incorporated into a laboratory information system
- Networking slide libraries to be consulted from distant facilities and research institutes
- Sharing expertise for evaluation processes and discussing
- Information storing (digital data does not deteriorate, are secure from damages and losses)

Main application fields are quality control & research, education, veterinary, histology / pathology, entomology / insectology, etc.

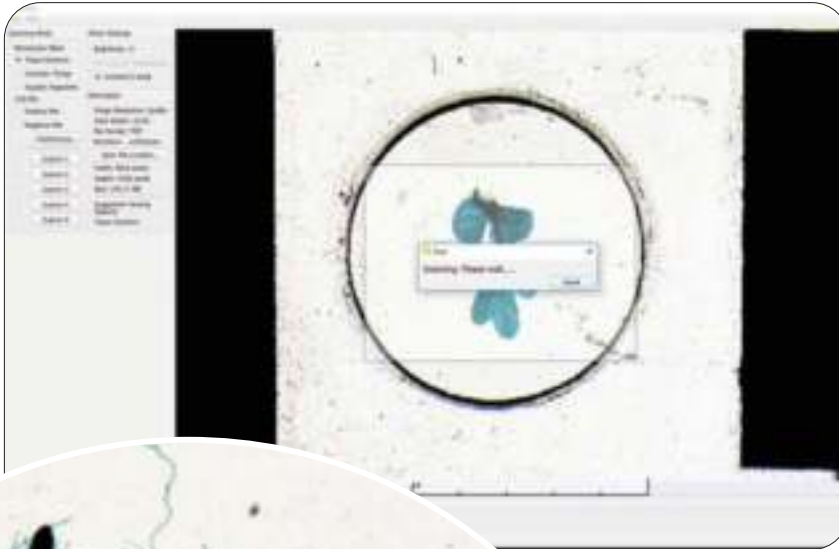

Main Features:

- High Resolution (up to 10.000 dpi)
- True & Neutral Color Fidelity
- White Balance & Distortion-free Images
- Dedicated Illumination (LED Transmitted Light)
- Efficient Scanning Area, Wide Field of View
- Impressive Scanning Speed (from 40 sec. to few minutes)
- High Sensitivity CCD Sensor
- Largest Field Of View, Better Than Any Camera



Ideal for:

- building up a comprehensive database of images for routine operations
- sharing expertise for evaluation processes
- archiving confidential patient information



OPTISCAN10 - Technical Specifications

OPTISCAN10 is an extremely convenient scanner for professionals, labs & teaching purposes, offering unmatched price/performance ratio and coming along with a comprehensive but user-friendly software.

A ultra efficient, compact scanning device carrying high resolution features for spot detection with easy operation figure.

It is equipped with a dedicated LED transmitted light system and high resolution CCD sensor, ensuring high sensitivity with low background noise.

Signal output	USB 2.0
Illumination	LED
Resolution	5'000 dpi (Normal), 10'000 dpi (Quality)
Allowed slide	Standard 24 x 75 mm
Scan view size	Any size, Max 24 x 36mm
Prescan function time	25 seconds
Scanning time (Normal)	1min 30sec (24 x 36mm); 40 sec (standard 15x15mm cover slide)
Scanning time (Quality)	2min 10sec (24 x 36mm); 1min (standard 15x15mm cover slide)
Always included	1.5 m USB cable, power supply, CD rom
System requirements	Windows XP service pack 2, Vista / win7 / win8 / win10 / 32-64 bit / USB 2.0
Supplied software	Multilanguage software for image scan
Capture features	Prescan, slide scan 24x36mm, crop scan, brightness, contrast, saturation, image flip



v 7.5 - OPTIKA reserves the right to make corrections, modifications, enhancements, improvements and other changes to its products at any time without notice.

Headquarters and Manufacturing Facilities

OPTIKA® S.r.l. Via Rigla, 30 - 24010 Ponteranica (BG) - ITALY - Tel.: +39 035.571.392 - info@optikamicroscopes.com

Optika Sales branches

OPTIKA® Spain spain@optikamicroscopes.com

OPTIKA® China china@optikamicroscopes.com

OPTIKA® India india@optikamicroscopes.com

OPTIKA® North America namerica@optikamicroscopes.com

OPTIKA® Central America camerica@optikamicroscopes.com

OPTIKA® Africa africa@optikamicroscopes.com

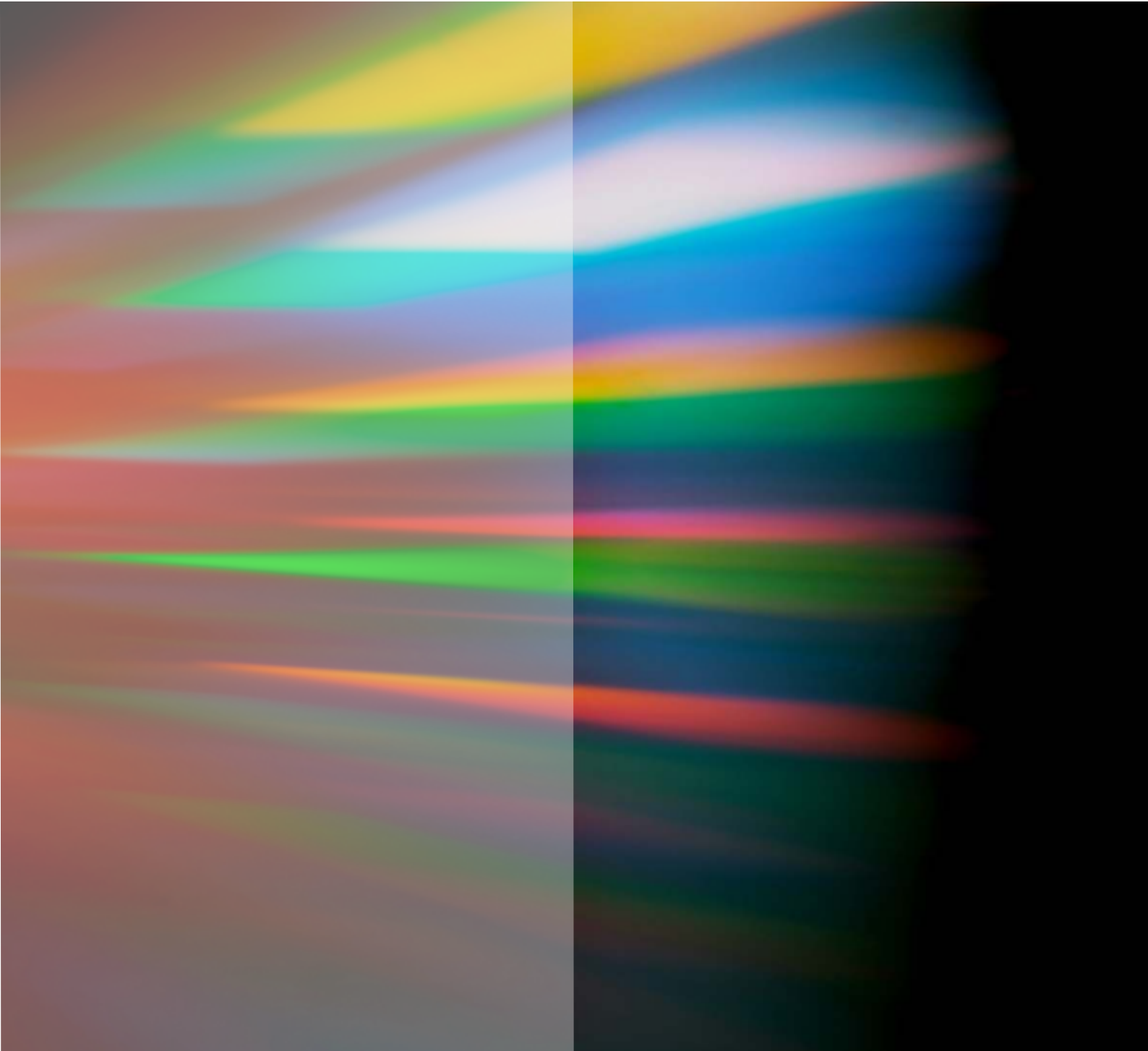

POLARIMETRY AND REFRACTOMETRY

Extremely Reliable Polarimeter for Practical Experience

THE STATE-OF-THE-ART POLARIMETER

Combining wide measuring range with simplicity

- » Entirely Made in Italy
- » Outstanding quality/price ratio
- » New design for a compact and space-saving solution

MONOCHROMATIC LED LIGHT SOURCE

Instead of traditional sodium bulb

- » Unparalleled illumination
- » 30x longer lifespan than conventional polarimeters
- » Plug & play, no heating time required



Polarimeter - POL-X

The POL-X polarimeter from Optika precisely determines the optical rotation of substances, quickly and easily. POL-X measures the optical rotation over the entire measuring range at the same high accuracy. It's suitable for many applications, from routine measurements to demanding experiments for innovative projects. With this new polarimeter, OPTIKA meets the requirements of the pharmaceutical, cosmetics, chemical and medical industries and creates an ideal tool for R&D applications.



Polarimetry is used in the Educational field (for physics & chemistry dept.) and for Quality & Process Control in Labs. It provides the concentration and purity of a substance before it is added to an expensive batch.



Optical rotation is an indispensable quality and identity assay for a wide range of critical industries. Food, drug, and flavors industries use polarimetry as a quality attribute both for raw ingredients and also finished products.

Polarimeter - POL-X

Technical Specifications

Measuring range of optical rotation: $\pm 180^\circ$

Resolution: 1°

Accuracy: 0.05°

Magnification factor of the glass: 4x

Light source: Monochromatic LED, 1.2 W, $\lambda_d = 590$ nm (equivalent to sodium lamp)

Length of test tubes: 100 mm and 200 mm

Weight: 1.7 Kg

Overall dimensions: 450x180x320 mm

Accessories:

POL-1.2 - 100 mm polarimeter tube

POL-1.3 - 200 mm polarimeter tube



Target Industries

Food

Concentration and purity of compounds (carbohydrates, lactose, raffinose, various starches, fructose, levulose, sucrose, natural monosaccharides, glucose, maltose, xylose) in sugar based foods, cereals and syrups.



Chemical

Identification and characterization of polymers (bio-, natural or synthetic), foods, cereals and syrups.



Pharmaceutical

Determination of product purity by measuring specific and optical rotation of amino acids, antibiotics, dextrose, steroids, amino sugars, cocaine, diuretics, tranquilizers, analgesics, codeine, serums, vitamins, etc.



Fragrance, Flavor & Essential Oils

Inspection of incoming raw materials, such as camphors, gums, orange oil, citric acid, lavender oil, spearmint oil, glyceric acid, lemon oil, etc.



Refractometers - HR & HRD Series



OPTIKA offers a wide range of hand refractometers to ensure incredibly rapid and convenient measurement of concentration in liquid and semi-solid samples, combining **accurate performance with excellent repeatability.**

The refractive index of a substance is related to its specific density; a refractometer is used to measure the purity or the concentration of a sample when mixed.

Refractometers are suitable for a wide range of applications, which includes the control of blend ratios in light industrial applications (such as glycols, battery acid, heat exchange fluids, coolants, quenchants and hydraulic oils) and represents the ideal solution for users working in the food industry (fruit, beverages, confectionery, jam, honey and other sugar based products).

- » **Easy operation**
- » **Built-in LED illumination**
- » **Brix or scale specific (including ATC)**
- » **Sturdy construction with rubber handgrip**

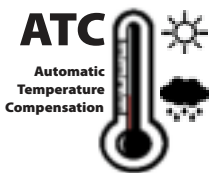

ATC - Automatic Temperature Compensation
No need to worry about temperature change during your measurement.

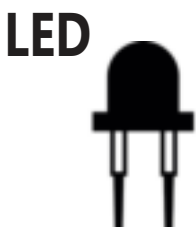

LED
Scale reading has never been so easy, also in case of low light conditions.



HR Series - Hand Refractometers

HR-110N - Hand Refractometer, 0-20% Brix, ATC, Built-in LED Illuminator

Measure Range	Min. Div	Accuracy
0-20% Brix	0.1 Brix	±0.10 Brix

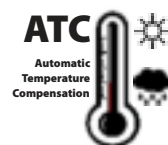

HR-130N - Hand Refractometer, 0-32% Brix, ATC, Built-in LED Illuminator

Measure Range	Min. Div	Accuracy
0-32% Brix	0.2 Brix	±0.2 Brix

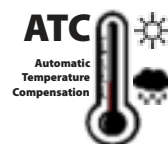
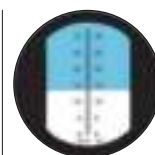

HR-140N - Hand Refractometer, 0-32% Brix, ATC, Triple Scale, Built-in LED Illuminator

Measure Range	Min. Div	Accuracy
0-32% Brix	0.2 Brix	±0.2 Brix
0-140 °Oe	1 °Oe	±1 °Oe
0-27 KMW(Babo)	0.2 KMW(Babo)	±0.2KMW(Babo)

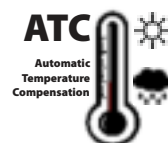
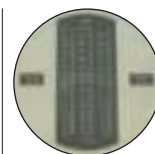

HR-150N - Hand Refractometer, 0-80% Brix, Single Scale, Built-in LED Illuminator

Measure Range	Min. Div	Accuracy
0-80% Brix	0.5 Brix	±0.5 Brix

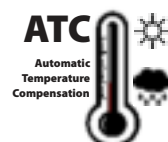
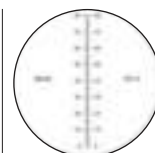

HR-160N - Hand Refractometer for Urine and Protein, ATC, Built-in LED Illuminator

Measure Range	Min. Div	Accuracy
1.000-1.050 sg	0.002 sg	± 0.002 sg
1.3300 RI - 1.3600 RI	0.0005 RI	± 0.0005 RI
0-12 g/dl	0.2 g/dl	± 0.2 g/dl

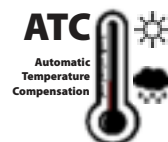
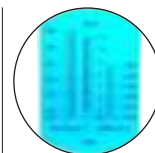

HR-170N - Hand Refractometer for Battery and Antifreeze, ATC, Built-in LED Illuminator

Measure Range	Min. Div	Accuracy
E: -60° F - 32° F	10° F	± 10°F
P: -50° F - 32° F	10° F	± 10°F
B: 1.15-1.30 sg	0.01 sg	± 0.1sg

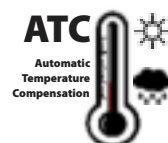
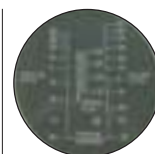

HR-180N - Hand Refractometer for Wine and Grape, ATC, Built-in LED Illuminator

Measure Range	Min. Div	Accuracy
0-80% v/v	1,0% v/v	±1,0 v/v



HR-190N - Hand Refractometer, 0-28% Salinity, ATC, Built-in LED Illuminator

Measure Range	Min. Div	Accuracy
0-28% Salinity	0.2%	±0.2%

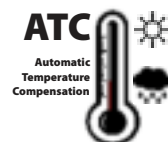
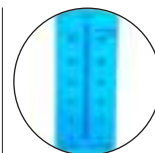

HRD Series - Digital Refractometers

HRD-300N - Digital Refractometer, Brix and Refractive Index

Measure Range	Min. Div	Accuracy
Brix 0-50%	0.10%	±0.2 %
Refractive index: 1.3330-1.4200nD	0.0001 nd	± 0.0003 nD

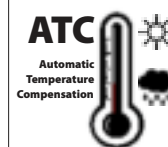

HRD-400N - Digital Refractometer, Brix, Salinity and Refractive Index

Measure Range	Min. Div	Accuracy
Brix 0-50%	± 0.1 %	± 0.2 %
Salinity 0.0-28.0%	± 0.1%	± 0.2 %
Refractive index: 1.3330-1.4200 nD	± 0.0001 nD	± 0.0003 nD



HRD-500N - Digital Refractometer for Urine, Serum Protein and Refractive Index

Measure Range	Min. Div	Accuracy
Urine SPG 1.000-1050	0.001	±0.002
SERUM P. 0-12 g/dl	0.1	±0.2
Refractive index: 1.3330-1.3900 nD	±0.0001 nD	±0.0003 nD

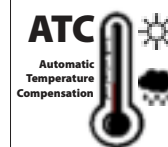

Refractometers - 2WAJ ABBE Bench Refractometer



Abbe bench-top refractometer measures refractive index ND and average color dispersion NF-NC of transparent and semi-transparent liquid or solid samples. It is a must-have equipment in factories, teaching institutes and science research centers related to oil, grease, pharmacy, painting, food, sugar-refining and geological industries, among the others. It is unique thanks to its ability in measuring also solid samples, such as film, glass, and other transparent materials.

- Main prism:** horizontal
- Secondary prism:** fitted on a hinge
- Refraction index scale:** Nd 1.300 – 1.700
- Precision:** Nd ± 0.0003
- Division:** Nd 0.0005
- Sugars scale:** 0-95% from Nd 1.300 – 1.530
- Precision:** 0-50% = 0.2%; 51-95% = 0.1%
- Division:** 0.25%
- Thermometer scale:** 0°C - 70°C, div. 0.1°C
- Weight:** 4 Kg
- Size:** 140x100x235 mm

v 7.5 - OPTIKA reserves the right to make corrections, modifications, enhancements, improvements and other changes to its products at any time without notice.

Headquarters and Manufacturing Facilities

OPTIKA® S.r.l. Via Rigla, 30 - 24010 Ponteranica (BG) - ITALY - Tel.: +39 035.571.392 - info@optikamicroscopes.com

Optika Sales branches

OPTIKA® Spain spain@optikamicroscopes.com
OPTIKA® China china@optikamicroscopes.com
OPTIKA® India india@optikamicroscopes.com

OPTIKA® North America namerica@optikamicroscopes.com
OPTIKA® Central America camerica@optikamicroscopes.com
OPTIKA® Africa africa@optikamicroscopes.com



OPTIKA Microscopes is committed to pursuing the full realization and continuous evolution of the Quality Management System in order to consolidate and improve the Company image, also through the commitment and professionalism of all Company staff.

v 7.5 - OPTIKA reserves the right to make corrections, modifications, enhancements, improvements and other changes to its products at any time without notice.

Headquarters and Manufacturing Facilities

OPTIKA® S.r.l. Via Rigla, 30 - 24010 Ponteranica (BG) - ITALY - Tel.: +39 035.571.392 - info@optikamicroscopes.com

Optika Sales branches

OPTIKA® Spain spain@optikamicroscopes.com
OPTIKA® China china@optikamicroscopes.com
OPTIKA® India india@optikamicroscopes.com

OPTIKA® North America namerica@optikamicroscopes.com
OPTIKA® Central America camerica@optikamicroscopes.com
OPTIKA® Africa africa@optikamicroscopes.com